

THE UNIVERSITY
OF ILLINOIS
LIBRARY

575.1

G22h

cop. 2

Return this book on or before the **Latest Date** stamped below. A charge is made on all overdue books.

University of Illinois Library

JUL -1 1943

MAY 05 1999

MAY 31 1945

AUG -1 1946

AUG -1 1946

JUN 01 2003

JUL 12 1947

DEC 08 2004

MAY 16 1961

NOV 21 2005

FEB 12 1984

JAN 4 1984

MAR 31 1980

MAR 27 1999



Digitized by the Internet Archive
in 2021 with funding from
University of Illinois Urbana-Champaign

LIBRARY
UNIVERSITY OF ILLINOIS
URBANA

HEREDITY AND EUGENICS

HEREDITY AND EUGENICS

BY

R. RUGGLES GATES, PH.D., F.L.S.

PROFESSOR OF BOTANY IN THE UNIVERSITY OF LONDON AND HEAD OF THE
DEPARTMENT OF BOTANY AT KING'S COLLEGE;
SOMETIME ASSOCIATE PROFESSOR OF ZOOLOGY, UNIVERSITY OF CALIFORNIA;
AUTHOR OF "THE MUTATION FACTOR IN EVOLUTION," ETC.

New York

THE MACMILLAN COMPANY

1923.

575.1
G 22 h
cop 2

TO
MY MOTHER
THIS BOOK IS AFFECTIONATELY DEDICATED

551018

Page 1

PREFACE

THIS book has been written partly by the accident of circumstances and partly by request. It is based upon a couple of articles which appeared in the *Eugenics Review* for January and April, 1920, and part of it was written during a holiday in America in 1921. Although my present interests are occupied with the field of modern botany, I was impelled to write this book by my interest in Eugenics, which is in turn founded upon a knowledge of genetics. The actual writing of it was, however, only made possible by the many friends in various parts of the world who have sent me their publications.

It is clear to scientific men, although rarely to statesmen and law-makers, that any intelligent attempt to improve the conditions and qualities of the human race must be founded upon some knowledge of the manner in which these qualities arise and are inherited and maintained or lost. In this book I have confined myself as strictly as possible to an examination of the facts of human inheritance, in so far as they are at present known, and I have laid particular emphasis—possibly too much—upon the many cases now known of Mendelian inheritance in man. This is not on account of any partiality for this particular form of inheritance; but because the Mendelian differences are clear cut and more easily recognised, and the manner of their inheritance is more easily traced and analysed and investigated than that of differences which can only be recognised as quantita-

tive, and whose precise manner of inheritance must still be regarded as under discussion.

The literature of the last two decades has recorded many cases of Mendelian inheritance in man, as the present book will, I think, testify. But it will also be seen that even the pre-Mendelian literature contained many scattered records of great interest which are now seen to fall into the Mendelian categories of explanation. I have made no attempt to search the literature exhaustively, as the work is really only a by-product of my own evolutionary interests, but I hope that no records of first-rate importance have been omitted, and I believe that several valuable early papers are here for the first time brought into orientation with the twentieth-century literature. The book might easily have grown to considerably greater proportions, but I have endeavoured to include only the more essential subjects and discussions which a book of this kind, written from the biological point of view, ought to contain. Whenever experiments with animals or plants bear directly on the topic in hand, I have not hesitated to use them, and I trust this will add to the value of the work, both to the general public interested in Eugenics, and the medical profession, who should always be on the alert to detect the inheritance element which so frequently is present in the functional derangements with which they have to deal.

Many matters which are primarily of genetic interest, but without at present any special bearing on human heredity, have been omitted altogether. If this work aids in the diffusion of an intelligent interest and understanding of heredity in its bearing on the welfare of future generations, its object will have been achieved. The conceptions of heredity are no longer vague and ill-defined, as in the writings of a generation ago. They are clear and sharply

defined, and are based on much accurate knowledge of organic structure and development. The germ plasm of the race is a uniquely precious material, and its conservation and improvement in each generation should be the first aim of the State. The first essential for such a conservation is the recognition of the inherent (inherited) differences in the capacities of individuals. Everything goes to show that once a particular strain of germ plasm is lost, it is gone for ever. In State recognition of the value of human germinal qualities, perhaps no country has equalled Sweden, where family records and genealogies have been kept for centuries in an exceptionally complete form, and where race biology is already recognised as a subject of the greatest national importance.

While it is necessary to recognise the fundamental importance of inherited physical and mental differences, as the foundation of Eugenics, one must also remember that environment counts in the sense that a favourable or suitable environment is required to bring out the potential qualities of any developing organism. Nevertheless, it is these potential (germinal) differences on which the Eugenist must rely in any effort to improve the race or direct the selection of germinal qualities which is going on in every generation.

In conclusion, I wish to thank those who, in various ways, have contributed to the production of this book. I am indebted to Professor R. C. Punnett, F.R.S., for permission to publish Figs. 4, 11, and 12, from the *Journal of Genetics*; to Sir Arthur Keith, F.R.S., for the loan of the blocks from the *Journal of Anatomy and Physiology*, January, 1916, which illustrate Figs. 13 and 14; to the Royal Society of Medicine for permission to reproduce Fig. 15 (from *Proc. Roy. Soc. Med. (Path.)*, vol. x., p. 60); and to the editorial board of the *Journal of Heredity*, for

permission to republish the photographs of twins in Figs. 29 to 34. Professor J. A. Platt has kindly supplied the original reference to Cæsar's horse, and I am indebted to Professor F. J. C. Hearnshaw for certain historical references. I am very much indebted to Professor E. W. MacBride, F.R.S., for kindly reading the proof-sheets and offering many valuable suggestions and criticisms; also to Professor A. Dendy, F.R.S., for certain suggestions. I alone, however, am responsible for the views expressed.

R. RUGGLES GATES.

KING'S COLLEGE,
UNIVERSITY OF LONDON,
December 27, 1922.

CONTENTS

CHAPTER	PAGE
<p>I. INTRODUCTION - - - - -</p> <p style="padding-left: 40px;">DEFINITION OF HEREDITY.</p>	<p>I</p>
<p>II. THE GENERAL ASPECTS OF HEREDITY - - -</p> <p style="padding-left: 40px;">INHERITANCE OF DIFFERENCES—MENDELISM—INHERITANCE OF RESEMBLANCES—DEVELOPMENT.</p>	<p>8</p>
<p>III. INHERITANCE OF PHYSICAL CHARACTERS IN MAN -</p> <p style="padding-left: 40px;">STATURE—EYE COLOUR—SKIN COLOUR AND HAIR CHARACTERS—ALBINISM—LEFT-HANDEDNESS—DIGITAL ABNORMALITIES—VARIOUS ABNORMALITIES.</p>	<p>27</p>
<p>IV. INHERITANCE OF MENTAL CHARACTERS IN MAN -</p> <p style="padding-left: 40px;">FEEBLE-MINDEDNESS—INSANITY—CACOGENIC FAMILIES—MUSICAL ABILITY—HANDWRITING.</p>	<p>145</p>
<p>V. THE LIMITS OF HEREDITY - - - -</p> <p style="padding-left: 40px;">TWINS—FINGER PRINTS—INHERITANCE OF TWINNING—LETHAL FACTORS.</p>	<p>175</p>
<p>VI. SOCIAL AND WORLD ASPECTS OF EUGENICS - -</p> <p style="padding-left: 40px;">THE BASIS OF RACIAL AND TEMPERAMENTAL DIFFERENCES—THE RESULTS OF CROSSING BETWEEN RACES—THE PROBLEMS OF POPULATION—POPULATION AND QUALITY.</p>	<p>204</p>
<p>LIST OF GENERAL WORKS BEARING ON EUGENICS - -</p>	<p>252</p>
<p>BIBLIOGRAPHY OF PAPERS CITED IN THE TEXT - -</p>	<p>254</p>
<p>INDEX - - - - -</p>	<p>273</p>

LIST OF ILLUSTRATIONS

FIG.	PAGE
1. DIAGRAM OF NORMAL \times BRACHYDACTYL - - -	10
2. DIAGRAM OF BRACHYDACTYL \times BRACHYDACTYL - - -	11
3. DIAGRAM OF HETEROZYGOTE \times HOMOZYGOTE - - -	12
4. ANTHR SHOWING SEGREGATION - - -	15
5. DIAGRAM OF DOMINANT \times RECESSIVE, F_1 - - -	18
6. DIAGRAM SHOWING THE F_2 IN THE ABOVE CROSS - - -	18
7. DIAGRAM OF SEX CHROMOSOMES - - -	19
8. DIAGRAM OF INHERITANCE OF SEX-LINKED CHARACTERS -	23
9. PEDIGREE OF TORTOISESHELL-COLOURED EYES - - -	49
10. PEDIGREE OF BOLLENBACH FAMILY - - -	56
11. PEDIGREE OF WHITE FORELOCK - - -	62
12. PEDIGREE OF ALBINISM - - -	67
13. BRACHYDACTYLOUS AND NORMAL HANDS - - -	79
14. RADIOGRAM OF A BRACHYDACTYLOUS HAND - - -	80
15. ABNORMAL SEGMENTATION OF FINGERS - - -	84
16. RADIOGRAPH OF HANDS OF A GIRL IN THE SAME FAMILY	85
17. SKIAGRAM OF HANDS OF A.T. - - -	87
18. PEDIGREE OF HEXADACTYLY - - -	104
19. PEDIGREE OF HEXADACTYLOUS FAMILY - - -	105
20. PEDIGREE OF COLOUR-BLINDNESS - - -	112
21. PEDIGREE OF FEMALE SEX-LINKED BLINDNESS - - -	117
22. PEDIGREE OF MALE SEX-LINKED BLINDNESS - - -	117
23. PEDIGREE OF MALE SEX-LINKED ICHTHYOSIS - - -	118
24. PEDIGREE OF FEMALE SEX-LINKED COLOUR-BLINDNESS -	118
25. PEDIGREE OF CLEFT IRIS - - -	120
26. PEDIGREE OF EARLY DECAY OF TEETH - - -	124
27. PEDIGREE OF RIGHT BILOBED EAR - - -	135
28. PEDIGREE OF SMALL PIT IN LEFT EAR - - -	136
29. PEDIGREE OF IMBECILITY IN FEMALE LINE - - -	154
30. IRISH SAILOR TWINS - - -	182
31. THEIR FINGER PRINTS - - -	183
32. TWINS FROM YORK, PENN. - - -	184
33. TWINS, MEN - - -	185
34. TWINS, WOMEN, MICHIGAN - - -	186
35. TWIN SISTERS, SWITZERLAND - - -	186

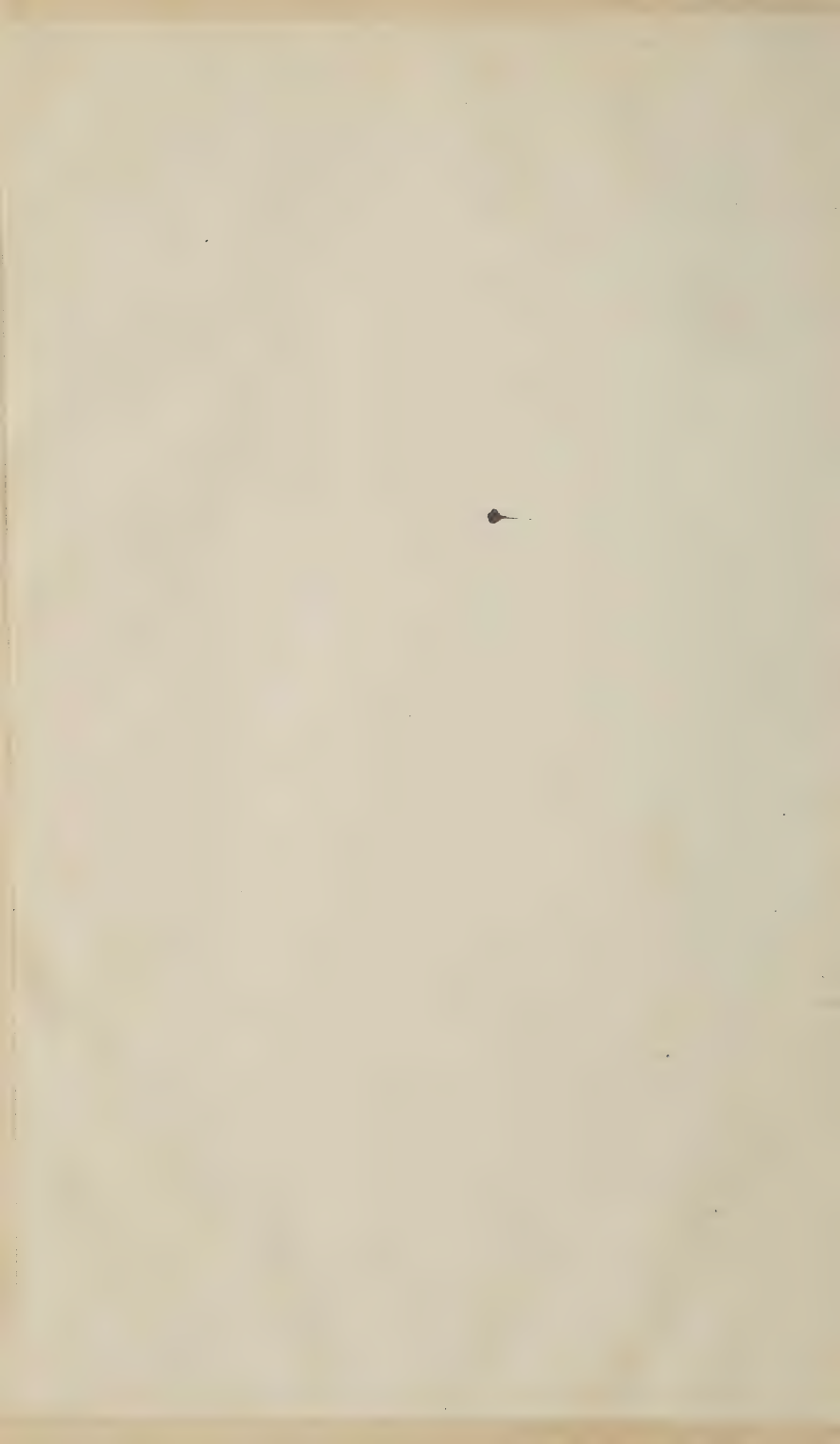

HEREDITY AND EUGENICS

CHAPTER I

INTRODUCTION

THE central problem of evolution is still the nature and causes of variation, while the practical problems of eugenics centre about heredity. Variation in past ages has already endowed the human race with an almost infinite variety of types and characters, many of the latter alternative in their inheritance. We have only to compare those we know best with their relatives and ancestors to realise how minute are the resemblances and differences which may be handed on to descendants and collateral lines. These are, no doubt, chiefly a matter of biological inheritance, though similarity of environment may play a part in certain cases. Probably in no other species of animal or plant does the number of differences between individuals approach the number to be observed in man. This is to be expected, because of the mental and physical complexity of the human organism; but it does not imply greater intrinsic variability than in other animals or plants.

Given this enormous complexity of types in the human species, and the inheritance of the innumerable differences involved, it follows that the matings of the present generation determine the characteristics which will be handed on to future generations. A knowledge of inheritance must, therefore, form the basis of any enlightened attempt to influence the

future development of the human race, which Sir Francis Galton originally contemplated in the Eugenic Movement. Popular writers frequently venture to deny the importance of heredity to mankind. They are willing to concede its cogency in animals, and, in fact, practical breeders of horses and dogs and other domestic animals rely upon heredity to perpetuate even slight differences in their strains. But they are often unwilling to accept for mankind the principles of heredity which they themselves have practised or seen in operation in other animals. Even those who recognise that the principles of heredity must be the same for mankind as regards physical characters, are sometimes inclined to deny that the same laws hold for mental characteristics.

It is therefore hoped that this book may help to bring the reader to a truer perspective regarding the nature and meaning of heredity, and its fundamental bearing on the future of the human race. False conceptions regarding inheritance are widespread, and this is not surprising in view of the complexity of the subject and the general lack of education in the biological sciences. Only in the last two decades, through experimental investigations with plants and animals, has any clear road been found through a mass of complicated data. It may now be claimed, however, that the general mechanism of heredity is well understood in many cases, and although, as in every science, complications continually arise with further knowledge, the principles already understood will form a sound basis for future advance.

It is impossible in this book to consider the whole field of heredity in general terms. For that purpose, reference may be made to various works on the subject which have appeared in recent years, during which the field of genetics has been an extremely active one. In this work an effort will be made to bring together

the more important data on human heredity which have accumulated chiefly in the last twenty years; but the general principles will be briefly discussed, and reference will be made to experiments, particularly with regard to the higher animals, when the results bear directly upon problems of human heredity. It will be seen that a large amount of information has already been gained regarding the inheritance of a multitude of traits, both physical and mental, in mankind. And perhaps the most surprising feature of these results is the minuteness and variety of the differences which are now known to follow definite laws of inheritance. But it is not necessary to rely upon recent work to establish the minuteness and peculiarity of some of the differences which are inherited in man. Darwin, who was unsurpassed as an observer, and, what is equally important, a collator of the observations of others, has a chapter on blushing in his book, *The Expression of the Emotions*, in which (p. 312) he cites, not only a number of cases of the inheritance of a tendency to blush, but also one in which mother and daughter blushed in the same peculiar manner. The tendency to blush excessively is due to a psychological peculiarity, while the distribution of the area over which a blush spreads must have a physical basis. That gait, gestures, voice, and general bearing are inherited, was recognised in the scientific writings of over a century ago, though imitation may also, of course, play a part here, but this is excluded in some cases.

Further random examples of inheritance in man will not be cited here, but the reader is invited to consider the mass of evidence found in the body of this book. It is believed that, in this way, any reader who is inclined to doubt the universality and importance of heredity in mankind will attain a truer perspective regarding the whole matter. But certain

misconceptions need to be pointed out first. The question is often asked whether heredity or environment is more important in connection with development. But the question cannot rightly be asked in this way, because any organism is the result of continuous complicated reactions and interactions, not only between the developing germ and its environment, but also between the different parts of the organism itself. Moreover, it is quite incorrect to assume that the organic germ and the environment mutually react with each other in any simple way. A particular change in the environment may conspicuously affect one part of the developing organism without visibly affecting other parts. Thus Stockard (1909) showed that when magnesium chloride is added to the sea water in which certain fish embryos are developing, cyclopean fishes are produced, with one median eye instead of two lateral ones. This is a surprising reaction of the organism, and more particularly of the nervous system, to a definite environmental stimulus.* Some differences in the environment will therefore produce very marked effects on the developing organism.

On the other hand, organisms developing in the same environment may show marked differences, because they have inherited different characters. Two hen's eggs in an incubator, under the same conditions of temperature, moisture, etc., may develop birds, one with a rose comb and the other with a single comb, or one with white feathers and the other with brown. Obviously the environment is not a differential, but the difference was in the original eggs and is inherited from the previous generation.

* Stockard's result has recently been shown to be due to differential destruction of the nerve plate in the embryo, the destruction beginning at the anterior end, as in Child's experiments with potassium cyanide.

No one would suggest that even if the eggs were incubated at different temperatures the single comb would be altered to a rose comb.

Clearly, then, some characters are produced by an environmental stimulus and others are determined by inheritance, although in both cases interaction of organism and environment takes place in the development of the character. A given character may occur in either or both categories. Thus fasciation or flattening of the stem in plants usually results from over-nutrition and is then, as a rule at least, not inherited at all. But in *Celosia cristata*, the coxcomb of gardens, extreme fasciation is a specific character, distinguishing this form from *C. plumosa*. Again, thickening of the epidermis or formation of corns results from friction of the skin of the hands or feet, and is not inherited. But keratosis is an inherited condition in which there is abnormal thickening of the skin without any excessive friction.

When a new character appears through a variation, the first question one asks is whether it is inherited. It is impossible to determine this with certainty except by experiment—*i.e.*, by breeding from the new type. If it *is* inherited, one must conclude that a germinal change has taken place, leading to the production of a new character, or at least that a germinal rearrangement has taken place, making possible the appearance of the new character. If it is not inherited, then the conclusion is that a modification has been impressed on the organism by some feature of the environment.* The question to ask, then, is not whether heredity or environment

* The possibility of the inheritance of acquired characters has not been considered here, because if it ever occurs in mankind it is probably too slow in its action to affect the practical problems of eugenics. The subject has been discussed from an evolutionary point of view elsewhere (Gates, 1921, chap. viii.-xii.).

is more important in the ontogeny of any character, but whether a difference (variation) which appears in an organism is due primarily to a difference in the environment or a difference in heredity (*cf.* Sumner, 1922).

This leads us to emphasise a point which is not always recognised—namely, that the relation between the organism and its environment is not the simple and direct relation between two reacting chemical substances—it is rather one of stimulus and response. It is, moreover, clear that not all elements of the environment are equally effective in modifying the organism. For example, a change in the light may have a striking effect on the development of one organism and no appreciable effect on another. The relations of an organism to its environment are therefore extremely complex, and can only be understood after elaborate analysis. But the higher organisms, and particularly man, have many regulatory mechanisms which enable him to triumph over extreme variations in the environment without being vitally affected by them. This, with his weapons and his intelligence, has enabled mankind to people the four corners of the earth in almost every extreme of climatic conditions where organisms can live at all. From a eugenic point of view it is to be remembered that while hereditary differences of all kinds are perpetuated in all conditions, yet optimum conditions are desirable for the full expression of the characters inherited by the organism. From this it follows that those who insist upon the importance of heredity in perpetuating good stocks should, at the same time, realise the desirability of creating an environment in which the best physical, mental, and moral qualities of the individuals can find free expression.

Before proceeding further it may be well to point out that whereas heredity was formerly defined or

measured by the degree of resemblance between parents and offspring, this treatment of the subject will no longer suffice. Thus Brooks (1906) says, "So far as the word is used inductively in biology, heredity is the resemblance of child to parent, of offspring to ancestor, while the difference between parent and child is called variation." The study of alternative inheritance, which appears to be the most usual form of heredity, has made it necessary to revise such a definition of heredity, as well as our outlook with regard to its incidence. It has now become a commonplace of observation that the differences between organisms, as well as their resemblances, are often inherited. If a tall is crossed with a dwarf variety, we know that usually the second generation will inherit tallness and dwarfness—the parental differentiating characters—in a definite proportion, and that certain of the tall individuals will go on transmitting dwarfness. We may even cross two white varieties of plants or two albino animals, externally alike, and obtain coloured offspring. Yet we know that the colour in this case is not the result of variation. One of the necessary elements in its production has been inherited from each parent, though neither possesses both. In such instances invisible (probably nuclear) differences have been inherited which, when combined, produce a striking externalised difference. Hence it is necessary, in speaking of inheritance, to recognise that both similarities and differences may be inherited, the one quite as truly as the other. Some of the differences, particularly the quantitative ones, which appear in offspring may, then, be the result of variation, germinal or otherwise; but many of them will be the result of inheritance.

CHAPTER II

THE GENERAL ASPECTS OF HEREDITY

MANY vague conceptions of heredity were formerly held, and much ink was unprofitably spilled in an effort to explain or elucidate inheritance in the absence of adequate experiment. Human inheritance particularly has been the subject of innumerable crude, unscientific conceptions such as "failure" of inheritance when a particular trait does not appear in every generation, a belief in maternal impressions, or scepticism regarding the inheritance of mental traits. The scientific investigation of heredity may almost be said to have begun with Mendel's studies of single characters in garden peas, since the results of the early hybridisers were so contradictory and confused—owing partly to an unfortunate choice of material for crossing and partly to an unsuitable method of experiment—that they never led to a consistent point of view on which future progress could build. The rediscovery of Mendel's principle of segregation in 1900 therefore marked the beginning of an era in the study of heredity. It has become progressively clearer that while mass statistics of resemblances may furnish useful information where no other is available, yet such data cannot furnish a basis for an understanding of the hereditary process. The experimental analytical method is necessary here, as in other fields of biology. The results of the experimental method, however, can be and have been applied to genealogical pedigrees of inheritance in man with illuminating results.

This method has, of course, certain definite limitations, since evidence is available only from such marriages as have taken place. But in many cases of simple Mendelian inheritance this evidence is quite as clear and unequivocal as though actual experimental crosses had been made for the purpose of determining the method of inheritance.

The number of characters in man which are now known to follow a Mendelian type of inheritance is surprisingly large. It is therefore desirable to elucidate briefly the principles of Mendelian inheritance for those who are not already familiar with the matter. An elementary treatment of the subject is to be found in Punnett's *Mendelism*. While thus emphasising the importance of Mendelian heredity, particularly as regards the inheritance of abnormalities in man, we wish also to stress the value of biometric studies of inheritance, for there are many characters in which this is the only method of analysis which can be applied. The two methods are complementary and are becoming more and more closely interwoven in the study of heredity. On the one hand, experimentalists are recognising the advantages of a mathematical analysis of their results, while on the other, biometricians realise the advantages of material under experimental control. The interaction of both methods produces the ideal result, but this is, of course, not always possible. The view taken here is that while Mendelian heredity is very common in mankind, especially as regards the inheritance of abnormalities, yet it is by no means universal. Many quantitative characters, and perhaps racial characters, will probably be found not to follow simple laws of inheritance involving fixed germinal units.

As an example of Mendelian inheritance let us consider brachydactyly or short fingers in man, the digits having two joints instead of three. This condi-

tion is dominant to the normal, which is spoken of as recessive. Brachydactylous individuals have always married normals. Persons showing this trait have therefore always been the children of one normal and one abnormal parent. They are therefore hybrid or heterozygous in nature as regards this character, and, since they are brachydactylous in appearance, this condition is said to be dominant to the normal. Now the essential feature of Mendelian behaviour is that the factors or determiners for such a pair of characters as normal and brachydactylous fingers separate in the formation of the germ cells, so that half the germ cells of a brachydactylous person who had one normal parent will carry the factor

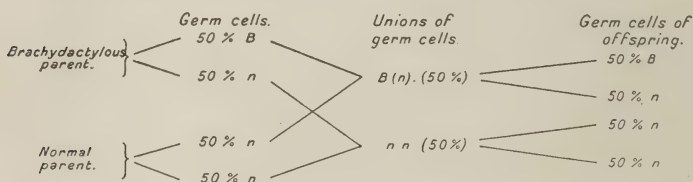

FIG. 1.—RESULT OF CROSS BETWEEN HETEROZYGOUS BRACHYDACTYL AND A NORMAL PARENT.

for brachydactyly and half will carry the factor for normal fingers. If such a person marries a normal individual, all of whose germ cells are therefore carrying the factor for normal fingers, then, on the average, half the children will be brachydactylous and half normal, for the chances for the germ cell matings—(1) normal \times normal and (2) normal \times brachydactyl—are equal. The result will be clear from the accompanying diagram (Fig. 1).

Hence we see that as long as matings of brachydactyls with normals continue, half the children will, on the average, be heterozygous brachydactyls (transmitting this character to half their offspring), while the other half of the children will be pure normal,

THE GENERAL ASPECTS OF HEREDITY 11

and transmit only the normal condition to all their offspring. In other words, the heterozygous dominants will continue to produce both types when mated to normals, while the normals derived from such a cross, being recessive, have entirely lost the brachydactylous condition (or rather never had it), and will therefore have only normal offspring even if two such normals from a brachydactylous cross mate together. For a full discussion of brachydactyly, see p. 78.

Many abnormalities in man are simple dominants and will therefore be inherited in this manner.

In order to make clearer the nature of Mendelian heredity, let us consider the other types of mating which commonly occur in organisms showing a single

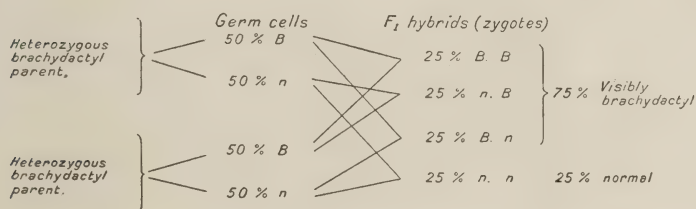

FIG. 2.—RESULTS OF CROSS BETWEEN TWO HETEROZYGOUS BRACHYDACTYL PARENTS.

difference. If two such individual organisms which are pure or homozygous are crossed, the first hybrid generation (written briefly F_1) will show only the dominant character. But if two of these F_1 hybrids are intercrossed, their offspring will number on the average three dominants to one recessive. Thus, in a marriage between two heterozygous brachydactyls, three-fourths of the children would be expected to be brachydactylous. The reason for this will be understood from the following diagram (Fig. 2).

The four possible combinations of the two types of germ cells will occur with equal frequency, and since the factor for brachydactyly is absent from only

one of the four combinations, it follows that only 25 per cent. of the offspring will be likely to have normal fingers. Of the other 75 per cent. which are brachydactylous, two out of three will be heterozygous (*i.e.*, with half their germ cells of each type), while one-third will be homozygous, carrying the determiner for brachydactyly in all their germ cells.

We may similarly consider the case where a heterozygous brachydactyl marries a homozygous brachydactyl.*

From the diagram (Fig. 3) it will be seen that the offspring from such a mating would be all brachy-

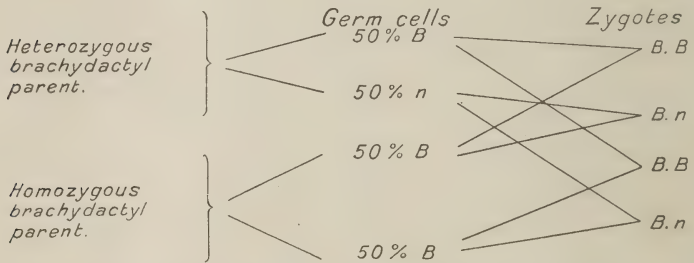

FIG. 3.—THEORETICAL RESULTS OF CROSS BETWEEN A HETEROZYGOUS AND A HOMOZYGOUS PARENT.

dactylous, half of them heterozygous and half homozygous. So long as the former continued mating with homozygous brachydactyls the normal condition would be completely suppressed, and the strain would appear to be pure for brachydactyly. But if in any generation two heterozygous individuals mated, there would be one chance in four of the recessive condition reappearing. The sudden appearance of a reversion or throw back in a pedigree strain, for example, of cattle, is no doubt often to be accounted for in this way. A recessive character may thus be

* There is some evidence that the homozygous brachyphalangous (related) condition is non-viable and therefore cannot exist (see p. 90).

carried in the germ plasm of a strain for many generations, only to crop out again when a chance mating of two heterozygous individuals takes place.

It is not known how or when brachydactyly originated, but it probably occurred centuries ago, and presumably arose in the first instance as a mutation—*i.e.*, a sudden and probably spontaneous germinal change.*

Fortunately, the segregation which takes place in germ-cell formation can now be referred to definite elements in the cells—namely, the chromosomes. These are the elements of the nucleus whose constancy in number and shape for each species of animal and plant is one of the remarkable features of organic structure. In the complicated process of mitotic nuclear division, which happens whenever cells divide in the growth and development of the organism, the essential fact is that they are split lengthwise, so that each daughter cell contains in its nucleus the longitudinal halves of every chromosome. Although these bodies seem to merge in the resting nucleus into a mass in which the outlines of the separate chromosomes are lost, yet there are cases in which the outlines can still be traced, each chromosome forming a separate compartment or vesicle of the nucleus. There is also evidence that the parts of the various chromosomes maintain their special relationships throughout the period between one division and another even when visible boundaries are lost, or, at any rate, that they reassemble with the same arrangement as they disappeared. There is something, not at present understood, which maintains the unity of the chromosome as a persisting structure, and determines the constancy of its relative size and shape during mitosis in the various parts of the organism.

* For a discussion of the causes and nature of Mutation, see Gates (1915, chap. ix.).

The organism begins its development from the union of the nuclei of egg and sperm. But when this union happens it is not a mere intermingling of two fluid substances, for the chromosomes, which are highly viscous in the condensed condition, maintain their separate identity; and in the subsequent nuclear divisions they frequently arrange themselves in pairs, each pair consisting of one chromosome of paternal origin (from the male germ cell) and one of maternal origin (from the female germ cell). In many animals and plants the various pairs are distinguishable from each other in size or shape. The chromosomes may therefore be said to possess individuality and to show genetic continuity from generation to generation.

When the germ cells of an organism undergo maturation as the organism develops, the chromosome number in them is reduced to one-half. The essential feature of this complicated process is the separation of the pairs of chromosomes which are characteristic of the somatic nuclei, so that the nuclei of the eggs and sperms receive one member of each pair and hence have half as many chromosomes as the somatic cells.* Half the germ cells will thus receive one member of each pair, and half the other. This maturation process has been studied in great detail in hundreds of plants and animals, as well as in man (see p. 20). In the separation of pairs in the reduction divisions there is free assortment of the chromosomes. (There are many reasons for believing that the chromosomes are the basis of Mendelian inheritance, and that the segregation of characters, which Mendel's experiments indicated took place in the formation of the germ cells, really depends on the separation of the chromosome-pairs in the reduction divisions.)

* Further complications of this process need not concern us here.

That segregation of factors really takes place during meiosis (the period during which chromosome reduction occurs) has been shown by the formation of two types of pollen grain in certain hybrid rice plants. In these F_1 hybrids half the pollen grains contain starch grains, like the pollen grains of one parent, while the other half contain no starch. Fig. 4, from a section of an anther treated with iodine, shows the two types of pollen grains scattered in equal numbers through the anther.

Thus in an organism which is heterozygous for one pair of characters, say short hair (dominant) or long "Angora" hair (recessive) in guinea-pigs, the F_1 hybrid animals will have short hair, and all their cells will contain a pair of chromosomes which differ in that one chromosome contains the determiner for short coat,

while its mate contains the determiner for long coat. When the germ cells of this guinea-pig are formed, this pair of chromosomes, like the other pairs, is separated, and half the eggs or sperms, as the case may be, get the chromosome with the determiner for short hair, while the other half receive its mate containing the determiner for long



FIG. 4.—PHOTOMICROGRAPH SHOWING SEGREGATION OF POLLEN TYPES IN A RICE HYBRID. (After F. R. Parnell.)

hair. From this it follows, as shown in the diagram in Fig. 1 (p. 10), that three-quarters of the individuals in the next generation (F_2) will have short hair, the remaining quarter having Angora hair. This is because when the eggs and sperms unite in fertilisation, half the eggs and half the sperms will contain the chromosome determining short hair, while the other half carry its mate with the determiner for long hair. The fertilised eggs will then be of three types: (1) containing a pair of chromosomes, both of which carry the determiner for short coat. When these eggs develop into organisms which can be bred together, they can obviously give only short-coated offspring. They are homozygous dominants. (2) These fertilised eggs will contain a pair of chromosomes with determiners respectively for long and short coat, and, according to the laws of chance combination, they will be twice as numerous as the last. They are the heterozygous dominants, their bodies indistinguishable from the pure dominants (when dominance is complete), but their germ plasm as well as all their body cells containing an "unequal" pair of chromosomes which will separate as in the F_1 to produce the next generation. These two classes of F_2 animals, together making up three-quarters of the offspring, are visibly short-coated. (3) In the third class of fertilised eggs both chromosomes of this pair will contain the determiner for long coat. They will develop into long-coated animals, their body cells and germ cells will all contain the descendants of this pair of chromosomes, and they will give long-coated offspring when bred together. They are the homozygous recessives, and because they result from chromosome recombinations taking place according to chance, they are as numerous as the first class, the homozygous dominants.

The history of the chromosomes in organisms was

worked out quite independently of genetic experiments, but they furnish precisely the mechanism required to explain Mendelian behaviour, although the main facts of their history were known before the rediscovery of Mendel's laws in 1900.) The number of freely assorting groups of Mendelian characters in a species should therefore be the same as the number of pairs of chromosomes, and the experimental work, particularly with the fruit fly *Drosophila*, clearly indicates that this is the case.

Differences in the chromosomes in crossed races appear to determine the different types and combinations of characters which arise in the offspring. It thus appears that Mendelian differences in general have originated as mutations, probably through an alteration in a portion or locus of a chromosome. That the differences which arise in this way are inherited as Mendelian factors results, then, from the manner of distribution of the chromosomes in the reduction divisions, when the nuclei of the germ cells are formed. Mutations seem to arise in the germ plasm at relatively infrequent intervals. They may then be handed down to later generations for an indefinite period. In some cases the same mutation appears independently more than once.

Let us now consider the inheritance of a recessive Mendelian character. Feeble-mindedness may be taken as an example, for it appears to be generally inherited as a simple Mendelian recessive. Constructing a diagram (Fig. 5), we see that all the germ cells of a feeble-minded person will carry the factor for feeble-mindedness, since the character is recessive.

If mated with normal, the children will all be normal for the same reason, and the defect will seem to have disappeared. But these normals will all be heterozygous, carrying the defect for feeble-mindedness in

half their germ cells. If two such persons mate together, it will be seen from the following diagram (Fig. 6) that half the germ cells of each will be normal and half carry the defect.

This will give four combinations of germ cells occurring with equal frequency. (Three of them, or

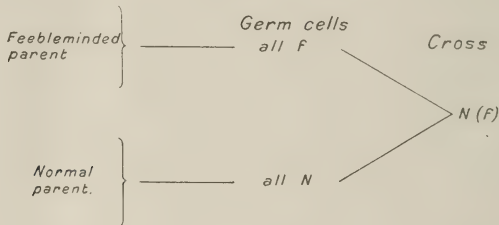

FIG. 5.—RESULT OF CROSS BETWEEN A DOMINANT AND A RECESSIVE CHARACTER IN F_1 .

on the average three-fourths of the offspring, will be normal, the other fourth will be feeble-minded. Moreover, of the normals two-thirds will be carrying feeble-mindedness as a recessive character while the other third will be untainted. Further, it is clear

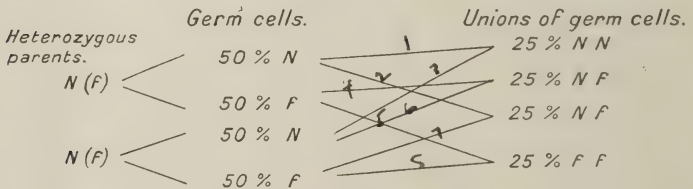

FIG. 6.—RESULTS OF ABOVE CROSS IN F_2 .

that if the Mendelian behaviour is strictly adhered to two feeble-minded parents can have only feeble-minded offspring. The exceptions to this rule, if they exist, are so few as to be negligible. For a further account of feeble-mindedness see p. 149.

There is no doubt that the germ plasm of any human

strain contains numbers of such recessive characters, which may be transmitted for generations without appearing, until union with an individual carrying the same recessive character may ultimately bring it out in some (25 per cent.) of the offspring. The presence of similar, undesirable recessive characters in the germ plasm is thus the chief danger from inbreeding or intermarriage of cousins. The main features of a recessive character are, then, that it disappears in the first generation of a cross between a pure dominant and a pure recessive, while it reappears in about one-quarter of the offspring of two

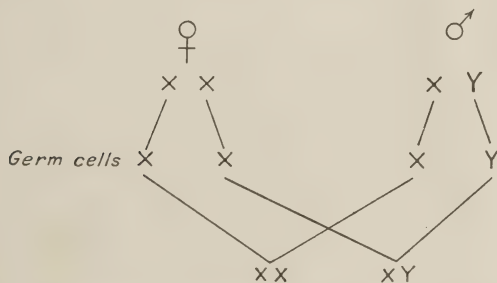

FIG. 7.—DIAGRAM TO SHOW THE HISTORY OF THE SEX CHROMOSOMES.

individuals heterozygous for the character. It will appear in about half the offspring of matings between a heterozygous normal and a (pure) recessive.

Another type of Mendelian character, which in its inheritance follows exactly the distribution of the sex chromosomes, is known as sex-linked inheritance. Such characters evidently depend for their origin upon mutations occurring in the sex chromosomes. As an example of this in man we may consider colour-blindness. The nature of this inheritance-mechanism will be clear from the following diagram (Fig. 7), showing the history of the sex chromosomes as they appear to behave in man.

The history of the sex chromosomes has been clearly shown in many animals, and in the fruit fly *Drosophila* a large number of sex-linked mutations, determined apparently by changes in loci of the X-chromosome, have been studied.

A brief account is first necessary of the sex chromosomes as they apparently exist in man. Although many observations have been made on the subject, the facts are not yet known with certainty; but the details are gradually becoming clear. It appeared at one time that the negro had 24 chromosomes and the white man 48, but this apparent difference may have been due to clumping of the chromosome pairs in the process of fixation, so that they looked like single chromosomes. Also in the earlier accounts one or two more chromosomes were found in the female than in the male, but later investigators are agreed that there is a pair (XY) of sex chromosomes which are distinguishable by their shape and behaviour from the other chromosomes. It appeared from the studies of Guyer (1910, 1914) and of Montgomery (1912) on human spermatogenesis that the male negro possesses 22 chromosomes, including 2 sex or accessory chromosomes. Montgomery found that the accessories were irregularly distributed in the reduction divisions. It was inferred that the female number was 24. Von Winiwarter (1912), however, studying members of the white race, found 47 chromosomes in man and 48 in woman (oögonial divisions). Farmer, Moore and Walker (1906), in examining pathological tissue (somatic cells) presumably of white people, found usually 32 chromosomes, while Wieman (1913) counted 33 to 38 chromosomes in a human embryo the parentage of which is not stated. More recently Wieman (1917) describes human spermatogenesis with 24 chromosomes in both negro and white, including an XY pair of sex

chromosomes which divide in the first reduction division and segregate in the second, unlike the other chromosomes which segregate in the first and divide in the second. Still more recently, Painter (1921), in a preliminary account of spermatogenesis in both whites and negroes from Texas, finds approximately 48 chromosomes in both, including an XY pair of sex chromosomes. This is a partial confirmation of Von Winiwarter. It might appear that all these investigators were right in their determinations of numbers, and that human individuals exist with 24 (2X or diploid), about 36 (3X or triploid), and 48 (4X or tetraploid) chromosome numbers. The chromosomes of all mammals are, however, notoriously difficult to deal with, and it seems more likely that clumping may have given rise to an appearance of lower numbers. The existence of triploid and tetraploid races of mankind would, however, be in accord with their occurrence in many species of plants and animals (see Gates, 1915, pp. 195 ff.). In any case, it seems clear that the higher number (48) of chromosomes is present at least in some men, and that an XY pair of chromosomes exists in the male.

It may be pointed out that the number 48 is a rather high one, and is approximately double the number found in some mammals.* It has, therefore, probably originated at some time by sudden doubling of the chromosome number, as this was originally shown to take place when *Œnothera gigas* appears as a mutation from *Œ. Lamarckiana* (see Gates, 1915, pp. 118, 209). Whether this doubling to produce 48 chromosomes occurred in some of the races of mankind, or earlier in his ancestry, remains to be determined. In the matter of relationships and phylogeny, as has recently been shown, in the varieties

* Painter (1922) reports finding 54 chromosomes, including an XY pair, in a ring-tail monkey.

of wheat, and in a number of other instances, the determination of chromosome numbers and shapes is of great value.

Returning to the question of human chromosomes, there are many difficulties attending their study, so that neither their total numbers nor the behaviour of the sex chromosomes can be regarded as settled. Von Winiwarter found an unpaired X chromosome in the male, while later workers are agreed in finding an XY pair. In either case, the mechanism of sex determination and the inheritance of sex-linked characters is essentially the same, so it will be assumed that the later work is correct in describing an XY pair. This type of sex-determining mechanism is well known in some of the insects. It may be briefly described as follows (see Fig. 8). Males have an unequal XY pair of sex chromosomes, the X usually being larger than the Y, while females have a pair of X chromosomes (XX). In the spermatogenesis of the male, the X passes undivided into half the sperm, while the other half receive the Y. Since the females have a pair of X chromosomes, all the eggs before fertilisation will contain one X. In fertilisation there is an equal chance that a sperm containing an X will enter an egg, and produce a female, or, that a sperm bearing a Y will function and so produce a male. Through this general mechanism an approximation to equality of the sexes is maintained. But it is now known that there are various conditions which may come in to disturb this tendency to equality in numbers of the sexes.

We are now in a position to understand the mechanism of inheritance of sex-linked characters, such as colour-blindness, in man.

The diagram shows only the sex chromosomes, which are XX in the female and XY in the male.

The underlined X is carrying the factor for

colour-blindness. The male, $\underline{X}Y$, would therefore be colour-blind. Mated with a normal woman, their male children would all be normal. The \underline{X} chromosome of the father, however, goes to all his daughters,

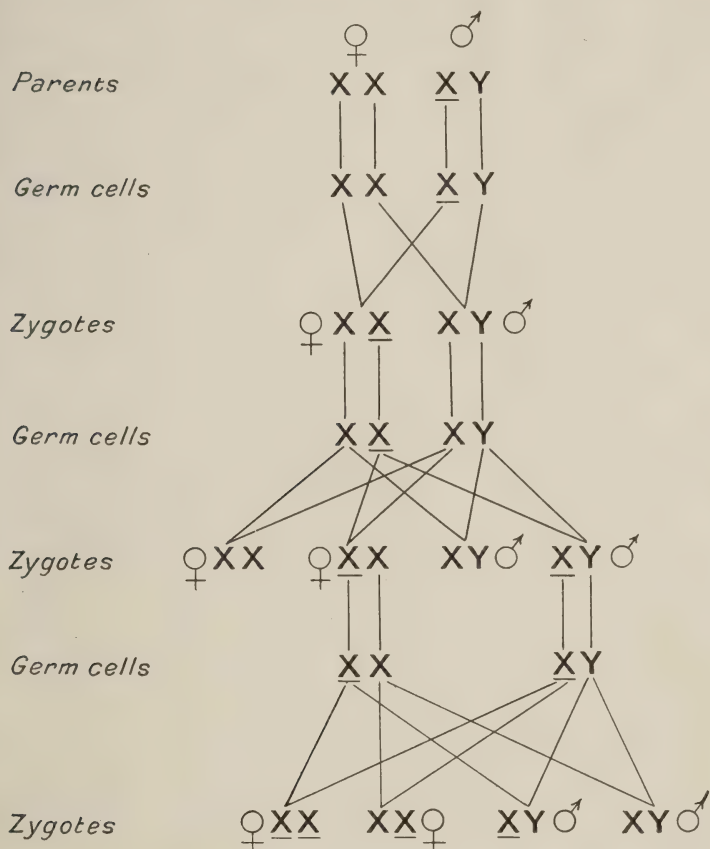

FIG. 8.—DIAGRAM TO ILLUSTRATE THE INHERITANCE OF SEX-LINKED CHARACTERS THROUGH THE X-CHROMOSOME.

who are all, therefore, transmitters of the defect to future generations. With a husband who is normal, they will transmit the defect to half their children of both sexes, as shown in the next two lines of the

diagram (Fig. 8), but only the sons will be colour-blind.

The last three lines show how a colour-blind father and a heterozygous mother will have a family in which half the daughters show the defect and half the sons will show it.* If the mother were homozygous for colour-blindness and the father also carried it, then all the children would be colour-blind. There is no instance of a colour-blind father transmitting the condition to the next generation, except in connection with a mother who transmits it. This criss-cross type of inheritance is more complicated than simple Mendelian behaviour in which both parents take the same part in inheritance, but it is simply explained by assuming the behaviour to be due to the transmission of a defective X chromosome.

[It appears, then, that in all these cases the fact that the differences are inherited as Mendelian factors results from the manner of distribution of the chromosomes in the reduction divisions at the time the germ cells of the organism are matured.] It may be that some of the fundamental *resemblances* between related organisms are inherited in a different way. Since in experimental breeding it is only possible to study directly the inheritance of differences, evidence concerning the process of inheritance of resemblances must necessarily be indirect and closely wrapped up with development itself.

We may now consider some of the differences appearing in man which so often follow one of these types of Mendelian behaviour. While dominance is very common, especially in connection with abnormalities, it is not by any means universal. There is, for instance, no dominance in such a character as skin colour, but the first generation is intermediate

* There appear to be some irregular cases in which colour-blindness shows in a heterozygous woman.

and back-crosses will further dilute the colour. It is probable that in organisms at large complete dominance is the exception rather than the rule. Why dominant mutations should be so numerous in man is at present quite unexplained. In *Drosophila*, only about a dozen dominant mutations have appeared among some 300, all the rest being recessive, and they are equally uncommon in other organisms.

The biological characters or differences observable in the human race and for the most part inherited include not merely the more striking racial divergencies, but also the innumerable structural and mental or temperamental differences that we see in the individuals of any population, however "pure" the race. Colour of hair and eyes, height and size of various parts of the body (for there is some evidence that these may be independently inherited for different segments), conformation of the head and features, size and shape of eyes, ears, nose, mouth, hands, and feet—there is good reason to believe that the element of inheritance enters largely into the perpetuation of a host of such differences as well as others more minute. Everyone can cite, from his own experience, cases of such essentially physiological traits as longevity and early baldness* or greyness "running in families."

* In an interesting study of the inheritance of baldness, by Dorothy Osborn (1916), she tabulated the results for twenty-two families and reached definite conclusions. Baldness is found to be a sex-limited trait, being inherited as a dominant character from father to son. In the woman it acts as a recessive, and may be transmitted as such, only appearing as baldness when present in the duplex (homozygous) condition. This may explain the greater rarity of baldness in women. Baldness is frequently associated with progressive decrease in the concentration of thyroid in the blood (see pp. 211 ff.). This view of early baldness as a sex-limited trait is borne out by data of Sedgwick (1863).

It is interesting to note in this connection that Duerden (1918,

Differences in reactions to serums and to various diseases, as well as other evidence, indicates the existence of corresponding chemical and constitutional differences between individuals. The inheritance of such differences is now commonly recognised. Only a few years ago, in the Law Courts, the disposal of a large estate turned upon a peculiar conformation of the ear occurring in the father and the supposed son.*

[A considerable body of detailed evidence concerning heredity in man has accumulated in recent years.] It is not my purpose to attempt anything like a complete citation of this work, but it may be of interest to enumerate some of the studies which have been made on this subject; for our knowledge of the inheritance both of normal and abnormal traits in man must always form the chief basis for eugenic action.]

1919) has shown that in crosses between the North African and South African ostrich the bald spot of the former behaves as a simple dominant character not sex-linked. In the chicks the head is covered with a bristly down, but in the North African birds this gradually falls out during the first few months and is not replaced by feathers.

* On the other hand, a case is cited (Jenks, 1916), with some evidence of authenticity, in which a girl of Swedish ancestry, whose ancestors of both sexes had been accustomed for many generations to wear earrings, was born with a hole in the proper position in each ear-lobe. That such cases of inheritance of a mutilation are admittedly rare does not necessarily prove that they are non-existent. The fact that (Windle, 1891) a fissure sometimes occurs in the sulcus intertragicus of the ear, as an arrest of development, scarcely seems an adequate explanation of the above case; but in an instance cited by Windle where the mother tore the lobule of her left ear when eight years old, and afterwards had eight children, one of whom, a boy, had cleft lobule of the left ear, there is obviously no inheritance involved.

CHAPTER III

INHERITANCE OF PHYSICAL CHARACTERS IN MAN

STATURE

Two of the earliest subjects studied in connection with human heredity were naturally enough stature and eye-colour. Galton dealt with these traits in his *Natural Inheritance*. I have pointed out elsewhere (1914) that Galton was a believer both in continuity and discontinuity in variation, and also in alternative as well as blended inheritance. His point of view with regard to the inheritance of these two characters may be well illustrated by a quotation from *Natural Inheritance* (p. 138): "Stature and eye-colour are not different as qualities, but they are more contrasted in hereditary behaviour than perhaps any other common qualities. Parents of different statures usually transmit a blended heritage to their children, but parents of different eye-colour usually transmit an alternative heritage." He also remarks (p. 139), "The blending in stature is due to its being the aggregate of the quasi-independent inheritance of many separate parts, while eye-colour appears to be much less various in its origin." Instead of Galton's conception of particulate inheritance, we now think in terms of such abstractions as multiple allelomorphs or multiple factors. But this conclusion of his concerning stature has been supported by Davenport (1917), who concludes from a considerable aggregation of analysed data that the correlation between "knee height" and "pubic arch minus knee

height " or length of thigh, is only 24 per cent.* Knee height includes height of ankle, which is considered an independent variable. The correlation between supra-pubic and sub-pubic portions of stature is found to be 30 per cent., and striking differences in the relative lengths of these portions of the body occur in different races of man. Thus Eskimo, Mongoloids, and some American Indian tribes have a relatively long trunk and short legs, while the Australian aborigines and some negro groups have a short trunk and long legs. Of the supra-pubic region, the supra-sternal or head and neck, and sub-sternal or trunk portion, are independent variables as regards length, with a correlation between them of only 9 per cent. A defect in these data is, however, the use of " sitting height " as a measurement, and the deduction of certain elements of the stature from that.

Thus, while inherited general growth factors, such as differences in the amount of secretion of various glands, are concerned in determining the adult stature as a whole, other factors are believed to control independently the length of the various segments which go to make up stature. Hence, according to this view, an individual may be tall because of the presence of general growth factors, or because he happens to have inherited length in each segment of his stature. If this is true, then, of the four segments that combine to form the total stature, any individual may be long in some and short in others. It is commonly stated that certain families have predominantly long trunks and short legs, while others may have short, stocky trunks combined with long or short

* The calculation of the length of different segments of the body by this indirect method introduces sources of error, as Castle points out, which, at any rate, weaken Davenport's conclusions regarding the inheritance of stature.

legs. A child may happen to inherit all the relatively long or short segment-lengths of its two parents, and may thus be considerably taller or shorter than either parent. Thus uniformity is not to be expected in marriages between tall and short people. I know personally of two cases of marriages between a very exceptionally tall man and an exceptionally short woman. In one case the son is tall, though not so tall as his father. In the other, the son is exceptionally short, like his mother.

Castle (1922) has recently criticised these conclusions of Davenport. He made a study of size inheritance in crosses between large and small varieties of rabbits and found the F_1 generations intermediate between the parental races, but nearer the size of the larger parent owing to heterosis or hybrid vigour. The latter phenomenon is well known. It is largely confined to the F_1 of both plant and animal hybrids, and probably occurs also in some first generation crosses of man.* Castle found that in crosses between two small varieties of rabbits, such as Polish and Himalayan, the F_1 was larger than either parent owing to this "hybrid vigour," but the effect was lost in the F_2 , which was strictly intermediate in average size. In crosses of either of these races with the much larger Flemish rabbit, the average size of the F_2 was strictly intermediate, but the range of variation was much greater than in F_1 . By the application of statistical methods it was estimated that eight or ten independent factors or linkage-systems affected the size.

Extensive measurements were made of weight, ear-length, and the dimensions of several bones. A study of the correlation between these measurements was made, in order to determine whether

* For a discussion of heterosis in hybrids see East and Jones (1919).

independent factors govern the size in different parts of the body. The correlation-coefficients obtained were uniformly high, and Castle reaches the conclusion that "the genetic agencies affecting size in rabbits are general in their action, influencing in the same general direction all parts of the body."

This important contribution of Castle to the subject of size-inheritance seems to indicate that, in so far as rabbits are concerned, there is no certain evidence of factors independently influencing the size of particular organs. Castle applies the same views to mammals and man, but not to plants where "hormone action is less in evidence." He regards the view of the genetic independence in size of the various parts of the body as a "sporadic relapse into preformationism," and denies that any lack of co-ordination of organs, such as Davenport has suggested, can arise through the crossing of different races of man. He points out also, that the measurements used by Davenport were not sufficiently precise to give reliable correlation-coefficients, and criticises the photographs of a Dinka negro and a Chiriguan Indian as evidence that length of legs and trunk is independently inherited. Castle suggests that there is the same difference in proportions between a boy and a man as between the Chiriguan Indian and the Dinka negro, and that the latter, therefore, merely represents a later stage of development. He believes that Southern Italians are short of stature and short-limbed because they cease to grow early, while Swedes and Scotch are tall and long-limbed because they mature later, in the same way that Flemish rabbits are large and have long ears because of their late maturity. Davenport also recognises general growth factors, and it is evident that the last word has not yet been said on this important subject. What is required is a mass of more accurate measurements.

Two earlier studies by Punnett and Bailey (1914, 1918) on the inheritance of weight in poultry and in rabbits also bear directly on this question. They crossed Gold-pencilled Hamburgs with Silver Seabright Bantams. The F_1 was not quite so large as the larger parent, while in F_2 and F_3 the range of variation is beyond that of either parent—*i.e.*, both larger and smaller birds were obtained. The results were explained on the assumption that four factors affecting weight were present, two of them being assumed to give an increase of 38 per cent. in a single dose or 61 per cent. when present in the homozygous condition. The other two factors were assumed to give 25 per cent. increase in weight in the simplex condition, and 30 per cent. in the duplex condition. The results are believed to give a clear indication that weight in poultry may depend on the presence of definite segregating genetic factors, and it is suggested that the increased size of some hybrids is not due to hybrid vigour, but to the bringing together of independent growth factors.

In their later study of weight in rabbits, Punnett and Bailey (1918) made crosses between the large Flemish rabbit and a mixed strain of Himalayan-Dutch-Havana of nearly uniform size. They also made certain crosses between Flemish and Polish rabbits. After making a careful study of the curves of growth in these rabbits, they conclude that "though animals belonging to large breeds may mature more slowly than those belonging to small breeds, it does not follow that age of maturity is closely correlated with size." The very small Polish rabbit is believed to mature a good deal more slowly than a larger form such as the Dutch, and the conclusion is reached that size and early maturity are to some extent transmitted independently. These conclusions are contrary to the view of Castle, who finds, from a study of growth-

curves in pure and hybrid races, that in Polish rabbits "the initial weight is less, the growth-rate less, and the completion of growth comes earlier," all these features combining to produce a smaller rabbit.

It is evident from these and other contradictory results that further studies of size inheritance in relation to rate of growth, etc., are necessary before any final conclusion can be reached; but it is highly probable that the same laws of size inheritance apply to man as to mammals, whatever those laws may be.* Castle's data provide strong evidence that in the strains of rabbits he studied general growth factors preponderated over any factors affecting only the size of certain parts. Nevertheless, the effects of a genetic factor are frequently confined almost entirely to one organ, and we see no reason why this should not apply to size factors as well as others. Wright (1918) in a statistical analysis of earlier measurements by Castle, of a stock of rabbits which gave strikingly high correlations between skull and leg measurements, brings out correlations which "suggest the existence of growth factors which affect the size of the skull independently of the body, others which affect similarly the length of homologous long bones apart from all else, and others which affect similarly bones of the same limb." The five measurements considered were length and breadth of skull, length of humerus, femur, and tibia. Analysis of the relations shows that in a population of rabbits most of the differences between individuals are those which involve the size of the body as a whole. But there is a certain amount of variation of each bone length independently of all others measured. There are also groups of bones, which vary together inde-

* There is much evidence in man (see p. 212) that the activities of various ductless glands, such as the thyroid and pituitary, control the size and development.

pendently of the rest of the skeleton. Two such groups are skull length and breadth and the three leg bones. Again, femur and tibia form a group subject to common influences which do not affect the humerus (foreleg). How far these variations were controlled by genetic factors is of course unknown.

Castle specifically confines to animals his view that all size factors are general, excluding it from plants on the ground of a greater hormone control in animals. But the apparent difference may simply be due to the present state of our knowledge. In plants it has been shown (Gates, 1917) that when a large-flowered species is crossed with a small-flowered one, an intermediate F_1 may be followed by later generations in which widely different sizes of flower occur simultaneously on the same plant, and even different lengths of petal in the same flower. This striking result, which has been studied on a large scale in *Enothera* crosses, shows that in plants, at any rate, organs of widely different size may occur on the same individual as the result of inherited differences.

Another important fact which bears on the whole theory of multiple factors in the interpretation of size inheritance has been brought out by Sumner and Huestis (1921). From extensive measurements of the right and left mandibles, femurs, and pelvic bones of the Californian deer mouse, *Peromyscus maniculatus*, they have constructed curves for the sinistro-dextral ratio for each bone—*i.e.*, the relative lengths of the corresponding right and left bones. The range of variation on either side of equality in this ratio is, of course, small in every case, but they are able to show statistically that the difference—*i.e.*, excess of length or weight on the right or left side—is, as might be expected, not inherited from one generation to the next. Nevertheless, if pure races are compared with hybrids, the F_2 generation shows

a considerable increase in the variability of these ratios. The authors rightly insist that this increased variability of the F_2 in characters which are demonstrably non-hereditary weakens very much the force of the evidence usually offered in favour of the hypothesis of multiple factors in size inheritance. An increased range of variation in F_2 hybrids cannot therefore in itself be accepted as evidence of the inheritance of multiple size factors. In the light of these results, the whole subject of size inheritance takes on new aspects and will require more critical re-examination.

As regards human dwarfs, they may be achondroplastic*—having short legs and long trunk—or ateliotic,† with normal proportions and reduced size (miniatures). (The former condition frequently skips a generation, and its heredity is uncertain, but it appears to be connected with derangements of the internal secretions.) A number of pedigrees of both types of dwarfs are described in the *Treasury of Natural Inheritance* (Pearson).

Rischbieth and Barrington (1912) have accumulated an enormous amount of information regarding dwarfism in the human race, with a number of pedigrees of its inheritance. Regarding achondroplasia, the condition may appear "accidentally" or it may be hereditary. Cases are known in which normal and achondroplastic babies occur in the same twin birth. The condition appears more commonly in girls than in boys, Kassowitz finding twenty-five girls and four boys in a total of twenty-nine cases. An achondroplastic mother may have children like herself or normal, and delivery must be by Cæsarotomy.

* Achondroplasia is a defect in the formation of cartilage at the epiphyses on the ends of the long bones, producing dwarfs.

† Ateliosis is arrest of development before it is complete.

Ateliosis or true dwarfism is considered to be rather rare. It is probably due to a defect of the pituitary. "There is a fair number of cases recorded in which offspring have been born to parents one or both of whom were ateliotic. These, however, with the exception of the cases quoted, have grown to a normal size, if they survived to adult years." Usually the condition is found in only one generation. In an exceptional case, an achondroplastic mother produced an ateliotic son by an ateliotic father. In another case, ateliosis occurred in father and son, and probably in the grandfather.

A condition in plants, which appears to correspond with achondroplasy, has been described in cotton, under the name brachysm (Cook, 1915). It consists in a great shortening of the internodes without any corresponding reduction in the diameter or in the size or number of other organs. This condition exists in the "bush" varieties of various vegetables and cereals such as beans and peas, tomatoes, oats and wheat. Kempton (1921) has studied it in maize, and finds that it is inherited as a simple recessive in crosses with the normal tall.

Ateliosis* in man appears to correspond to many of the ordinary dwarf varieties of plants and animals, though Davenport thinks it is due to dominant inhibiting factors. In some plants at least smaller cell size is involved. A well-known pedigree of the ateliotic type of dwarfism occurs in two families in the Tyrol which have intermarried, and Pearson suggests that it may here be inherited as a recessive from an ancestral stock.

Dwarfing of the type which produces general reduction in size is often the result of unfavourable

* Among horses, most ponies, such as the Shetland variety, appear to be ateliotic miniatures, while the Chinese pony, with short legs and stout body, is apparently an achondroplastic dwarf.

conditions or general inhibition to growth. The Japanese method of producing dwarf trees by starvation is sometimes copied by nature. When a tree seedling germinates in a cleft of a rock where little nourishment is obtainable it may struggle on for decades, making an infinitesimal amount of growth each year. Various instances are known in which domesticated animals in becoming feral under a rigorous climate have decreased conspicuously in size. This is probably the history of the Shetland ponies and others. It is certainly the origin of the somewhat larger ponies from Sable Island, Nova Scotia. These are known to be descended (St. John, 1921) from horses taken to this desolate little island from Massachusetts. The history of these horses and other feral animals on Sable Island is of such interest, in showing how a group of animals may react when removed from the care and selection of civilised man, that I refer to the subject at some length. The facts are taken from St. John (1921) and Gilpin (1864).

Sable Island is a long crescent of sand dunes, now twenty miles long and less than a mile wide, about 150 miles east of Halifax, Nova Scotia. When first visited in the sixteenth century, it was apparently ten miles longer and two miles wide. Every few years a great storm washes away some part of the island. The higher dunes now reach nearly 100 feet, but were formerly higher. It is surrounded by shoals, and hundreds of wrecks have occurred on its shores, giving it the lugubrious distinction of being the "graveyard of the Atlantic." On this inhospitable island the Portuguese landed cattle and pigs about 1520. In 1633 a writer reported, "about 800 cattle, small and great, all red, and the largest he ever saw." Large numbers of wild cattle were afterwards shipped from the island, according to a letter written in 1686,

and in 1738 there were no cattle left there. Evidently the cattle never became so truly feral as the horses, which were landed afterwards. Unlike the latter, they sought shelter from human habitations in storms, also they *increased* in size and remained uniform in colour. The hogs also ran wild, and became quite fierce. But they were all destroyed in 1814 "because of their ghoulish tastes when shipwrecks occurred." English rabbits, as well as rats, cats, dogs, and foxes, were introduced in turn, the native red and black foxes having become extinct. These introductions furnish an instructive instance of how one species may prey upon and quickly exterminate another.

But the history of the horses is of greatest interest. In 1753 there were twenty or thirty horses on the island descended from animals landed some time earlier. About 1760 Thomas Hancock, a Boston (Mass.) merchant, landed horses, cows, sheep, goats, and pigs. By the end of the American Revolution, all had been killed except a number of horses. Many of the horses, as well as other animals, had been eaten as food by shipwrecked mariners. The horses descended from this stock are well described by Gilpin (1864), who visited the island about 1864, and found some 400 wild ponies in about six herds, each headed by an old male with masses of mane and tail. Each herd had its own feeding ground, and they separated again when driven together promiscuously. The males often fought savagely, and they appeared to sleep standing and never to lie down to rest, always fleeing from man and shelter. Thus in one hundred and fifty years or less they had returned to the habits of the wild tarpany horse, with which they agreed in size, hairy heads, and thick coat, though differing in form in some respects. They are said to reproduce wonderfully the forms of horses known only from the sculptures of Nineveh and the friezes of the Par-

thenon, having the same short cock-thrappled neck, hairy jowl, and horizontal head. As regards colour, bays and browns were most numerous, then chestnuts, a few blacks, no greys, one probable red roan, one pure white, many piebald, and many "bluish mouse colour"* often with a black stripe along the back, but none with black lines around the legs.

The striking features in the history of these horses appear to be (1) the complete reversion to an ancestral condition, with change of form and decrease in size; (2) the large number of colour varieties. Mere inbreeding will not account for the former. The colour varieties may, perhaps, all have been represented in the germ plasm, the piebald and bluish colours being extremely old. Piebald horses have existed in all ages. According to Gilpin, they are depicted on the most ancient coins of China and were contemporary with the siege of Troy, being still seen feral in Northern Italy. They have also appeared in Patagonia and among the horses of the North American Indians. The structural changes involved in the reversion of these Sable Island ponies must have resulted in some way from the rigorous conditions. How the environment acts in such cases is not clear. It may be partly by direct inhibition of development, and partly by selection of smaller varieties requiring less food. It may also involve the reappearance as fresh mutations of conditions which had previously been selected out of the germ plasm by the action of man. The small human races in some inhospitable climates may, perhaps, be accounted for in a similar way—*i.e.*, by the selection of variations, sometimes negative, which made survival more likely, as well as by the direct inhibiting effects of unfavourable conditions. But

* This "Phrygian cerulean blue of Homer" is scarcely known among modern domestic breeds.

this is obviously not the place to analyse such possibilities from the evolutionary point of view.

That the diminution in size of a species may happen very quickly is shown by garden vegetables which are allowed to run wild, or by the immediate and rapid increase in size of wild species taken into a garden. This appears to be due to the fact that conditions of culture permit of the rapid accumulation of reserve material. Such instances as the following in animals show rapid decrease in size: Dr. John D. Caton (1887) tells how a male and four female wild turkeys were sent from his grounds in Ottawa to Santa Cruz Island, twenty miles off the coast of California. This island is thirty miles long and five to ten miles wide. Here the turkeys had no enemies except a small grey fox. In a few years they became very abundant and very much smaller, the largest weighing not over 6 pounds, or less than one-third the size of the first and second generations bred there. In this case the mild climatic conditions could not have been responsible, the food supply was abundant, the birds were vigorous and healthy, and there was no evidence of any epidemic. The wild turkey was formerly abundant in Arizona, and birds introduced on the mainland of California north of San Francisco were prolific and of normal size. The cause of the decrease in size of the Santa Cruz birds, therefore, remains unexplained.

Davenport is inclined to conclude from his studies of human stature that "in both ateliosis and achondroplasia in man there are multiple dominant (growth inhibiting) factors, whose actions are often obscured by opposing epigenetic growth factors, and which are probably of a different sort in ateliosis than in achondroplasia, for achondroplasia affects chiefly or exclusively the appendages." Evidently much has yet to be learned of the inheritance of these

conditions in man, as well as concerning the effective environmental factors which are involved in producing racial differences in stature.

A condition which bears some resemblances to achondroplasia, but was probably of a different character, appeared in a flock of sheep in 1791 (Humphreys, 1813). The so-called Ancon sheep originated from a single ram in the flock of a farmer in Massachusetts, near Boston. This ram had short, bandy legs and a short back. The character was evidently a simple Mendelian recessive, and had probably been carried in the stock for some time before it was brought out by inbreeding. The breed seems to have attained some popularity because they could not jump fences; but their crooked forelegs, loose joints, and flabby subscapular muscles made them difficult to drive to market, their carcasses were smaller, and they became extinct some time after 1813. This is an excellent example of man's power over variations in domestic animals, first to multiply them and afterwards to bring about their extinction when they were found less serviceable.

A somewhat different account of the origin of this breed was given by Timothy Dwight (1822, vol. iii., p. 134). He says that about 1798, in Mendon township (Mass.), about eighteen miles south-east of Worcester, "an ewe belonging to one of the farmers had twins, which he observed to differ in their structure from any other sheep in this part of the country." The twins are said to have been of different sex, and to have been bred together to produce the new race. Dwight stated that their bodies were thicker and more clumsy, they were more gentle, and have since multiplied to many thousands; when crossed with other breeds, they always resembled entirely either the sire or the dam.

The dachshund among dogs appears to have re-

sulted from a similar mutation, although here the back is long, as also in the turnspit. A variety like the turnspit, having crooked legs and a long back, was formerly known among the pariah dogs of India.

To quote some of the further conclusions of Davenport regarding heredity of stature in man, he finds that the time of onset of puberty is probably an element in determining the stature ultimately reached by the individual, and that the factors for tallness are mostly recessive—probably due to the absence of inhibitions to prolonged growth. The least variable offspring are, therefore, the children of two tall parents, all being usually tall, while tall mated with short will give the most variable result owing to the recessive factors for greater stature carried by the short parent.

An interesting experimental result bearing on the subject of gigantism has recently been obtained by Uhlenhuth (1921). He fed young salamanders (*Amblystoma*) on a pure diet of the anterior lobe of the hypophysis (pituitary*) of cattle, control animals being fed with earthworms. A greatly increased rate of growth resulted, and when the normal adult size was reached growth continued at a decreasing rate, until animals of gigantic size were produced. The hormone† from the anterior lobe of the hypophysis not only accelerates growth, but also maintains growth after the normal adult size is reached. Carrel finds that in tissue cultures the growth of the cells of warm-blooded animals is not accelerated by hypophysis extract, and various investigators have shown

* The pituitary is a small reddish ellipsoid organ in a depression (the sella turcica) at the base of the skull. It consists of anterior and posterior lobes.

† A hormone is a chemical substance produced as an internal secretion in a gland or organ and carried in the blood-stream in minute quantities to control the activity of another organ.

that the division rate of protozoa is not affected by the extract. The continued growth of the salamander is evidently due to continued cell multiplication rather than increase in the size of cells, the hormone effect being probably not directly on the cells of the body, but through the intermediary of some other substance which stimulates cell growth and division in all the tissues.

In plants it has been shown by Bottomley (1917) that auximones or growth-promoting substances, bearing certain resemblances to the vitamins,* may be obtained from the water extract of bacterised peat. These substances are probably organic decomposition products obtained in peat which has partially decomposed under anaerobic conditions, and is then acted upon by aerobic bacteria. When 368 parts per million of organic matter from the water extract was added to a culture of *Lemna minor*, grown in nutrient solution, the effect was remarkable. In six weeks the increase compared with that of control plants was sixty-two times in weight and twenty times in number of plants. The increase in size was striking, not only as regards the individual plants, but also in the cells, nuclei, and chloroplasts.

That gigantism of body and of cells in plants is also often associated with tetraploidy or doubling in the chromosome number has been shown by Gates (1909) and by Tupper and Bartlett (1916), with detailed measurements of cells and nuclei in various tissues. This is another example of the same morphological difference being produced by an external stimulus, in which case it is not inherited, or by a germinal change, when it *is* inherited.

* Vitamins are substances of vegetable origin whose presence in minute quantities is necessary for the proper development of the higher animals and man. In their absence such diseases as scurvy, beri-beri, and rickets develop.

The data of inheritance of gigantism in man include some interesting cases in the tall Scotch population of North Carolina and Kentucky. It is concluded by Davenport that excessively tall stature is the result of inherited excessive activity in the pituitary gland, the factors for tallness being mostly recessive, due to absence of inhibition to prolonged growth. It is clear that gigantism and dwarfism are not merely the extreme terms in a single series, but they are conditioned in inheritance by entirely different physiological and developmental processes.

Windle (1891) quotes from Francesco Leporató the case of a dwarf born of normal parents. At the age of 83 years he was 1.130 metres high. By a normal wife he had six children whose heights are given. They were all dwarfs but one normal daughter, their heights ranging around that of the father. One son, Antonio, married twice, both wives being normal, By the first he had a normal daughter, and by the second three children who were below normal. Another son, Pietro, married a normal woman and had three small children, all of whom when measured were below the normal height for their age. Dwarfing in this family appears to be strongly dominant.

Stature is, of course, also a racial characteristic. The tall races are found in North-Western Europe, the Polynesians, North American Indians, and some negro tribes of the Soudan and Central Africa. Their height is 68 inches or over. The short races comprise those of Indo-China, Japan, Malaya, the Hottentots, and Eskimos. Many dwarfs are small because they cease growth at an early age; others are very small at birth and grow slowly. According to Davenport (1917), the average stature of man ranges from 4 feet 6 inches in the Negrillo Akkas to 5 feet 10 inches in the Scots of Galloway. Frederick Wilhelm of Prussia contemplated breeding a race of tall grenadiers for

his battalions, and Catherine de Medici is said to have endeavoured to produce a race of dwarfs by bringing about matings between them.

EYE COLOUR.

The Mendelian studies of eye colour up to 1912 were summarised by Hurst (1912). He defined three patterns of distribution in the pigmented eye: self, where the brown is distributed all the way to the periphery of the iris; ringed, in which the brown is confined to a ring around the iris; and spotted, in which irregular spots and patches occur on a blue background. The blue or grey colour represents absence of brown pigment, and is simply the apparent colour of the muscle fibres in the iris as seen through the cornea.

A recent paper (Boas, 1919) presents statistics of eye colour which, it is claimed, do not support the Mendelian contention that two blue-eyed individuals have only blue-eyed offspring. But the writer admits that in collecting these data, persons with a certain amount of brown in their eyes may have been classed as blue-eyed. Pearson and others have also studied carefully some of the more detailed differences in eye pigmentation which are important for a complete analysis. It is clear that the conception of a single Mendelian factor difference between brown and blue eyes is only a rough first approximation in the study of this subject.

Usher (1920), from a careful histological examination of six albino eyeballs, found traces of pigment in four. The fifth was unknown, and the sixth, that of an infant, was devoid of pigment. Usher therefore concludes that total absence of pigment cannot be used as a definition of albinism in man. The *fovea centralis**

* This is a pit in the middle of the macula lutea or point of clearest vision at the centre of the retina.

in albinotic eyes is shown to be absent or imperfect, and this may be the chief cause of the imperfect vision in such eyes. In the eyes of albinotic individuals belonging to dark races the mesoblastic pigment appears earlier and is found in much larger quantity at time of birth than in European eyes. Chemical examination indicates that there is more pigment in the eyes of albinos of dark races than of white races. This is in line with much evidence from mammals of a close relation between density of coat colour and of eye pigmentation.

Recent studies of brown and blue eyes indicate that they are not always a simple pair of Mendelian characters as formerly supposed, but sex-linkage and other complications may come in. Bryn (1920) collected statistics in Norway and states that in four out of thirty marriages two blue-eyed parents had some brown-eyed children. From these four marriages there were ten children with brown eyes and seventeen with blue. One or both grandparents, in all cases, had brown eyes. Winge (1921), in a much more extended study, criticises these results and concludes that such cases are exceedingly rare if the parents have normal vision. By means of a questionnaire, Winge collected data of eye colour in about 1,400 children of natural history association members in Denmark and their parents. The data obtained were carefully sifted, and the results are given in the table on p. 46.

From the table it will be seen that, in addition to the seven children with doubtfully blue eyes from blue-eyed parents, twelve children (belonging to eight families) had brown pigment in their eyes. Further information obtained from five of the families indicates that the condition was due in two cases to abnormalities in the eye. In another family of seven, two of the daughters had some brown pigment in

their eyes, and one of the latter married a blue-eyed man and had six children, all blue-eyed. This case is thought to be explained by assuming that one of the grandparents was genotypically* brown-eyed but had a "pigment restrictive disposition" which made him or her phenotypically (that is, visibly) blue-eyed. The brown-eyed daughter having blue-eyed children is explained by sex-linked inheritance. It is shown from other evidence that pigment-inhibiting factors may be accompanied by abnormalities in vision, but the interpretations in this part of the paper are not always convincing.

TABLE I.
INHERITANCE OF EYE COLOUR (WINGE).

<i>Marriages.</i>	<i>Number of Children.</i>			<i>Total.</i>
	<i>Blue.</i>	<i>Brown.</i>	<i>Greyish-Green or Bluish-Green.</i>	
Blue × blue ..	625	12	7	644
Blue × brown and conversely ..	317	322	9	648
Brown × brown	25	82	—	107
Total ..	967	416	16	1,399

Perhaps the most interesting results of Winge concern the sex-linked inheritance of eye colour. The statement that there are more brown-eyed women than men was borne out by statistics of 300,000 school children, collected by S. Hansen. Similar results have been obtained by others. Winge shows the fact of sex-linkage by giving the results of marriages in which the parents had different eye colour. These are appended in the following tables:

* That is, in inherited germinal constitution.

TABLE II.
MOTHER BLUE × FATHER BROWN.

<i>Eye Colour of Children.</i>	<i>Sons.</i>	<i>Daughters.</i>	<i>Total.</i>
Blue	63	50	113
Brown	65	81	146
Greyish-green or bluish-green	4	2	6
Total	132	133	265

TABLE III.
MOTHER BROWN × FATHER BLUE.

<i>Eye Colour of Children.</i>	<i>Sons.</i>	<i>Daughters.</i>	<i>Total.</i>
Blue	101	103	204
Brown	87	89	176
Greyish-green or bluish-green	—	3	3
Total	188	195	383

Clearly from the tables, when the father has brown eyes, half the sons have blue eyes and half brown, but many more daughters have brown than blue eyes, although the total numbers of the sexes are equal. On the other hand, when the mother has brown eyes there is a marked excess of blue-eyed sons and daughters. After an elaborate analysis these results are explained by assuming that in addition to the simple pair of factors originally recognised, there is another dominant factor for brown eyes which is sex-linked in inheritance. The writer is further obliged to assume that female germ cells (b W) containing the sex-linked factor (W) together with the ordinary determiner for blue, cannot exist. It should not be difficult to obtain extensive data of eye colour to test these hypotheses. All the assumptions made are reasonable enough in the light of

present genetic knowledge. It is well known that in rabbits and guinea-pigs factors for coat colour also often affect eye colour.

Having stated some of the facts as found, several criticisms of the present Mendelian position as regards eye colour are necessary. In the first place, many grades of brown exist, both as regards shade of colour of the iris and distribution of pigment. In an accurate study of eye colour these shades and varying distributions should be distinguished, and only lumped together for certain statistical purposes. It may turn out that all the shades of iris pigmentation do segregate sharply from pure blue, but much more extensive and accurate data will be required than are at present available before any certain conclusions can be drawn. It appears that even a difference in pigmentation of the two eyes may be inherited in certain families, and when the effects of various abnormalities of the eye in distorting or inhibiting the pigmentation of the iris are considered, the necessity for accurate and prolonged observation is obvious. On the other hand, in the light of the complications as regards eye pigmentation disclosed in *Drosophila*, it is by no means improbable that when sufficiently analysed, the pigmentation of the iris in man will be found also to follow Mendelian laws. But it is necessary to emphasise the necessity of very accurate and detailed first-hand observations of parents and children. The existence of all intergrades of colour and distribution of pigment in the iris is well known. Whether the detailed facts will bear a complicated Mendelian analysis remains to be seen, but there is nothing at present to negative that possibility.

The writer recently had the opportunity of examining the eye colour of people in Bergen, Norway. Only about one in fifteen would be roughly classed as brown-eyed, but the blues varied continuously

from very light to very dark blue, and so through greenish or yellowish shades (due to a small amount of brown pigment) to pale brown, dark brown being rare. Every grade of colour appeared to be represented, with a great predominance of the paler shades.

Sedgwick (1861) describes an interesting family in County Wexford, Ireland, with tortoiseshell-coloured eyes. The third generation, numbering sixteen sons and five daughters, all had the peculiarity, which they inherited from their mother. The mother had three sisters and a brother with the same colour of eyes, which was in turn inherited from *their* mother. Hence the character was a simple Mendelian dominant.

Bond (1912) has studied the inheritance of the con-

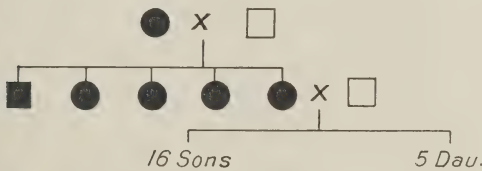

FIG. 9.—TORTOISESHELL-COLOURED EYES.

dition known as heterochromidia iridis, in which the two eyes are of different colour. In addition to the patterns recognised by Hurst, he distinguishes between self colour and the ray pattern, in which only one or more sections of the iris are pigmented. This condition is a fairly frequent one, and shows inheritance, though the position of the ray or sector is variable from one generation to another. Bond finds that the two eyes are unlike in pigmentation in perhaps one or two individuals per 1,000. In rabbits the condition is much more common, sometimes four in 100. Horses with a " wall " eye are, of course, well known, and in various breeds of dogs, such as Great Danes, English collies, and Old English sheep dogs, the condition is not uncommon. In both horses and dogs it is fre-

quently associated with a patchy or piebald coat. Both conditions may arise when self colour is mated with white, and in some cases it may be looked upon as a phenomenon of disintegration following on the quantitative dilution of a factor for pigmentation. It resembles in this respect the striping of flowers (see p. 58). Because factors may be diluted and disintegrated in this way by crossing, it is not necessary to assume, as Bond does, that there were originally independent factors for each eye and subordinate factors independently controlling different areas of the iris. There is no evidence that factors have been built up in this way. They appear rather to originate as germinal changes or new conditions of equilibrium, which may later become modified by crossing or otherwise.

A number of observations on the eye colours of birds and their inheritance are recorded by the same writer (Bond, 1919). His studies were chiefly of pigeons and fowls, although references are made to many other species. The pigment granules producing eye colour may be black, brown, yellow, ruby, or pearl. The "bull" eye owes its black colour, as in the white fantail pigeons, to the absence of pigment from the anterior surface of the iris. The posterior uveal pigment shines through the translucent tissues of the iris and gives the eye its colour, as in blue human eyes. Also, as with blue eyes in man, the "bull" eye of the chick is retained in the adult. The ruddy glow of this eye is due to the plexus of bloodvessels. (A similar type of eye occurs in guinea-pigs of the type which Castle calls red-eyed silver agouti). But in most birds with dark or black eyes, the colour is due to the presence of anterior iris pigment. In the rock pigeon (*Columba livia*) the iris colour is yellow or orange, while in other pigeons it may be white or red, and in the stock dove (*C. *œnas**)

the eye is peculiar, its black colour being due to the presence in the iris and in deeper tissues of branching cells packed with dark granules.

In the pearl or white eye of pigeons and the "daw" eye, as in the Malay fowl, there is no anterior pigment in the iris, but its tissues are opaque, owing to the presence of crowded colourless granules. This apparently corresponds with the "wall" eye in horses, dogs, and pigs. The muscle fibres of the avian eye, however, are striated or voluntary, and not plain as in the mammals. Pearl eye in pigeons is recessive to yellow or "gravel" eye, as "daw" eye in fowls is to amber or black eye when the latter is due to anterior pigment. The yellow eye derives its colour from a network of branching cells containing yellow granules. If the latter are closely packed, the eye may appear black. In fowls the yellow eye may be due to (1) granules in the connective tissue cells; (2) granules in the striated muscle cells, as in Dorkings and Orpingtons. In owls the yellow eye is due to bright yellow granules in cells coating the iris.

Brown and black eyes in birds are produced by a layer of branching cells on the iris containing dark pigment granules. Ruby eyes are produced in various ways in different birds; and some birds, such as certain birds of paradise, have parti-coloured irides. Genetically, black due to pigmented iris is dominant over yellow and other grades of iris pigmentation.

SKIN COLOUR AND HAIR CHARACTERS.

Hurst (1912) has summarised the studies on hair and skin colour in man, and added some observations of his own. The main points with regard to hair colour are: (1) That the brown shades of colour appear to be continuous from white (albino) hair to jet black; (2) the reds form a separate series due to a

lipochrome (a group of animal-fat pigments), while the brown is a melanin (a dark pigment found in hair, etc.); and (3) the generalisation of the Davenports (1910) that (with rare exceptions) children never have darker hair than their darker parent. This "non-transgressibility of the upper limit." applies also to skin colour or complexion in the white races. Davenport (1913), from a study of mulatto families in Bermuda, Jamaica, and the United States, concluded that there are probably two segregating Mendelian factors for black, and that other negroid features, such as kinky hair and thick lips, segregate independently. The same would appear to be true for mental characters, since mulattoes sometimes display high intellectual ability, but never pure negroes, as far as is known.

The evidence in favour of a strictly Mendelian explanation of colour inheritance in white-black crosses is, however, by no means conclusive. Pearson (1909), from data supplied by a medical man in the West Indies, gives quite a different picture. The first cross gives a brown mulatto or a yellow mulatto, and the basis or cause of this difference is not apparent. In crosses between mulattoes "there are now and then slight variations from the usual mulatto brown or mulatto yellow," but never pure black or white. Sports or throwbacks rarely occur, but the form where the tint is barely evident is said to be not uncommon. Mulatto \times negro produces the sambo, a deep mahogany brown, and it is said there is never any other colour from this cross. Mulatto \times white produces the quadroon, which is never pure white, but almost invariably lighter than the brown mulatto and nearly always lighter than the yellow mulatto. This gives the impression of intermediacy in the various hybrid conditions, with a not very marked tendency to segregation, which is never complete.

Evidently what is required is an extensive collection of accurate data based on careful measurements of pigmentation with colour tops before this complex subject can be fully understood. Probably something more complicated than the two-factor hypothesis of Davenport is required to explain all the facts of colour inheritance in white-black crosses. In how far real permanent blends occur remains to be seen. Although individuals occur in later generations who pass for whites, it is not certain that the pigment is ever entirely lost, though it is probable that the presence of other negroid features gives the impression that more black pigment has been retained than in the normal brunette skin.

Jordan (1911), in a histological study of melanogenesis in mulatto and white skins, finds that the only factor in skin pigmentation is the number of (yellowish-brown) granules and the number of cells containing such granules. Some mulattoes are identical with negroes and others with brunettes in amount of pigment. The apparent continuity in the melanogenetic process is believed to rest in mulatto families upon discontinuities or discrete units controlling the production of melanin granules. Such conditions conform more or less closely to an alternative mode of inheritance.

Sedgwick (1863) refers to silvery grey hair of very coarse texture as being present in about one in ten or twelve of the Mandan Indians, irrespective of age.

The various types of hair in the different races of man—straight, wavy, kinky, and curly—are known to differ in the shape of a cross-section, straight hair being circular in cross-section, kinky hair elliptical, with the other types intermediate. Little is actually known regarding the inheritance of these differences. Bean (1908) has studied the hair types among the hybrid Filipinos, in which the Chinese element fur-

nished the straight type of hair. Hair was classed as straight when the relative diameters in cross-section were 100:90 or over, wavy when 100:70-90, and curly when 100:60-70. In 31 families in which the cross was wavy \times straight or curly \times straight, there were 157 children, of whom 84 had straight hair to 73 curly or wavy. This approximates to a Mendelian 1:1 ratio; but dominance, when it occurs, is variable, and although segregation occurs to some extent, there is no close conformity to simple Mendelian behaviour. Wavy is regarded as a heterozygote of curly and straight, curly being recessive, but there is no sharp line between wavy and curly. Wavy \times wavy gives all three types in approximately equal proportions. Straight \times straight gives all three types, but with a large preponderance of straight. Curly \times straight gives mostly straight if the father's hair is straight, but more curly if the father's hair is curly. These results for Filipinos appear to be generally the reverse of those obtained in America. (See photographs in *Journal of Heredity* 7:412 [1916].) Bond (1912) cites certain cases of negro-white crosses in which wavy and kinky hair both appear in the same individual, the hair being wavy on the vertex and kinky on the sides of the head. Three such cases are figured.

In a little-known work on the hair of mankind, Friedenthal (1908) gives descriptions with numerous coloured plates showing the distribution of hair on the human body, and the extremes of plus and minus variation in various races of man and in some apes. Aino of Japan are figured, in some of which almost the entire body has a hairy covering, and these are compared with certain European variations in which the whole face is covered with hair. Darwin* cites a Siamese family which for three generations had the face

* *Animals and Plants*, i. 448.

and body covered with long hair. This was accompanied by deficient teeth. He also refers to a woman with completely hairy face, exhibited in London in 1663.

E. Fischer (1910) has given the history of an interesting family in Upper Alsace, near Colmar, some of whose members were almost entirely devoid of hair. Daniel Bollenbach, belonging to the second generation of the pedigree (see Fig. 10), had no hair of the ordinary type, but his whole head bore a very scattered, soft down, about 1 centimetre long, composed of soft, thin, colourless hairs. Under the microscope they are seen to have no central medulla or pigment granules, to be somewhat thinner than ordinary hair, and twisted. Amongst these are a very few longer (3 centimetres) and somewhat thicker, pale reddish, delicate hairs. Under the microscope these show a normal central medulla and a weak reddish-brown pigmentation. Eyebrows and eyelashes are lacking. The arms and legs are hairless; also there is no breast hair or axillary hair. The nails of the toes and fingers are deformed, becoming thick and rough. The teeth decayed early, leaving many stumps. There is here the well-known correlation between deficiencies in teeth, nails, and hair. Some other members of the family have a few hairs on the body.

The inheritance of this hairless condition shows peculiarities (see chart, Fig. 10), which are difficult to explain except perhaps on an hypothesis of variable or reversed dominance of a single Mendelian factor. The character itself seems to have appeared suddenly through a germinal change, since the two generations preceding its original appearance were all normal, although they included cousin marriages which would probably have brought out a recessive character if it had been present. It will be seen (Fig. 10) that in the F_1 Mathias, who was normal, had only normal

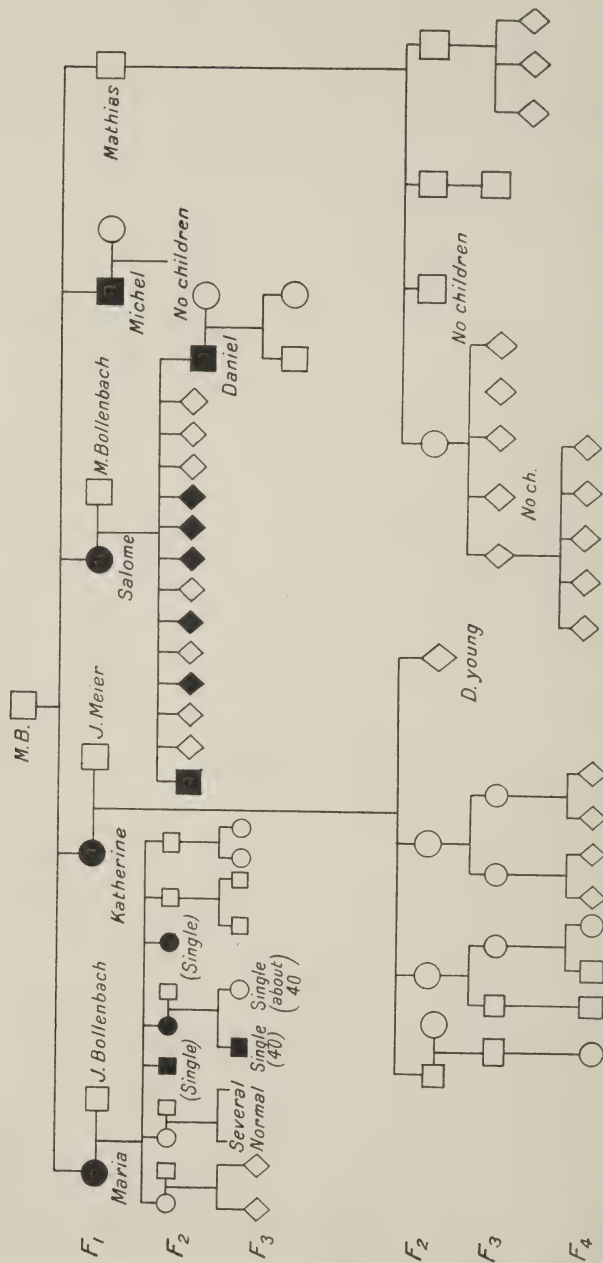

FIG. 10.—PEDIGREE CHART OF FAMILY SHOWING ATRICHOSIS (ABSENCE OF HAIR).

In this and following pedigree charts, black always means the presence of the abnormality, white its absence. The squares are males, circles females, and diamonds of unknown sex. (Chart modified after E. Fischer.)

descendants, but Katherine (abnormal) also had only normal descendants through three generations. If the character were recessive its absence here would be explained, since her husband was probably homozygous normal. Maria and Salome, if their husbands (Bollenbach) were heterozygous, should have half their children of each type. The actual numbers were three normals to four hairless and seven normals to seven hairless respectively. The numbers are, of course, too small to make a certain interpretation, but the most likely interpretation appears to be that the character behaved as a recessive. In the case of Katherine, it is very unlikely that it would fail to appear in any of her four children if it were dominant. The fact that the sex of so many of the children is unrecorded indicates that the records are not, perhaps, very accurate.

Inbreeding does not explain the origin of this character, which was probably due to germinal change, and if the Bollenbachs were homozygous it would behave partly as a dominant. The abnormal section of the family is fast dying out. Sexual selection is apparently a factor, for abnormal members of the family often remain single. Of the fourteen children of Salome, all died but one (Daniel), who had two children, only one of which reached maturity. Michel remained childless. Only two abnormal members of this family remain—both old men. At their death, the abnormality will be lost after fifteen abnormal individuals had appeared in three generations. This is a marked case of an abnormality appearing suddenly and then disappearing in a few generations.

ALBINISM

The monograph on albinism in man, by Pearson, Nettleship, and Usher (1911-1913) is a very elaborate and detailed treatment, which will serve as a basis

for all future studies on this subject. It gives not only an elaborately illustrated description of the external features and the histology of the skin and eye pigmentation in albinotic individuals, but also deals with the history of the subject. Pure albinism is a recessive character*: but the condition exists in varying degrees, and its inheritance, like that of so many human qualities, frequently shows complications. Complete albinism occurs in both white and coloured races of man. Pearson divides albinotics into six classes. Several cases of white spotting in negroes, similar to the classical types seen in paintings of the eighteenth century, have been described in modern times. The evidence certainly, as Pearson (1913) contends, favours the hypothesis that spotting arises *de novo* where a white-black cross or mixed race is crossed back with a pure white or black. In other words, spotting may be considered to arise in certain cases as a somatic segregation, repulsion, or dilution effect, and not to be due to an inherited invisible spotting factor. Striping in various flowers is generally believed to have originated in the same way. A similar case occurs in certain *Œnothera* hybrids (Gates, 1915). When *Œ. rubricalyx* having dark red buds is crossed with *Œ. grandiflora* having green buds, the F_1 is paler red. If this F_1 generation is crossed back with *Œ. grandiflora*, the colour is further diluted, becoming very pale; and in some families the pattern breaks up into spots, a condition which is inherited.

Once this spotted condition has arisen, it appears then to be fairly stable. Cases of human albinotic spotting are on record which have been transmitted for two to five generations (Stannus, 1913). The condition of spotting has, in some way, become stabilised in the germ plasm, and should, therefore, probably

* A recent case in which two complete albino "white" parents had an albino son is illustrated by Davenport (1916).

be looked upon as a mutation following crossing. Moreover, the spotting in man often follows a characteristic pattern, beginning as a blaze in the forehead, with spotting of the arms, the back largely black, as well as the extremities. Curiously enough, photographs of the Honduras piebald (Pearson, 1913) seem to show an extension of some of the coloured spots as the child develops. The sporadic manner in which spotting appears in all such cases remains to be accounted for. The Honduras piebald had five siblings,* all normal mulattoes. His mother combined Mexican and negro blood, while the father was a pure negro.

In an interesting case recorded by Dr. Stannus and cited in the monograph on albinism, piebaldism was found to occur in five generations of a family of natives at Florence Bay, Nyasaland, appearing in nine individuals. Albinotic patches occurred in the median line, on the anterior half of the scalp, in the epigastric region, and broad "garters" about the knees. The inheritance here extended to the position of the patches.

In an English family the inheritance of a white forelock has been traced through six generations by Harman (*Trans. Ophthal. Soc.*, 1909). The white forelock is accompanied by a patch of white skin spreading like a flare down the middle of the forehead. In some members of the family there are also patches of pure white skin on the median line of the trunk or the inner sides of the calves. The eyes were normal, with no white eyelashes or parti-coloured irides. The members of the family are long-lived and robust, but have a tendency to early whitening of the hair. This piebald marking was found in twenty-four individuals belonging to nine childships among a total of 138 individuals in the six generations. The children of normals were all normal. In the first

* This term means brothers and sisters taken collectively.

three generations all showing the mark were females, but in the last three generations affected males and females were equal in numbers, and inheritance was thought to be through the males only. The data indicate, however, that the peculiarity is inherited as a simple Mendelian dominant, chance accounting for the absence of affected males in the early generations, and the small number of females who were mothers in the later generations accounting for the later lack of transmission through the mothers.

Pearson (1921) has recently described another very similar case, with a white patch or flare on the forehead and hair. In this family there were seven affected members in four generations. This family also goes grey very early, and there is some tuberculosis but no consanguinity. This feature, of course, resembles the white "star" marking often seen in the forehead of horses and cattle, and frequently accompanied by white patches on the extremities. In this family the original great-grandmother in the pedigree must have been heterozygous. In the succeeding three generations the numbers of members which were normal or flared were respectively 3:2, 4:1, and 6:3, making a total of 13:6. This is a rather wide departure from the ratio which would be expected if the trait were a simple dominant, the odds against its occurrence being 17.5 to 1. But since unaffected members never transmit the flare, it cannot be a regular recessive. If the character is, as in other cases, a simple dominant, the small numbers showing the flare might, perhaps, be accounted for on the assumption of the decreased viability of such heterozygous individuals.

The occurrence and inheritance of a differently coloured, usually white, patch of hair, is a fairly common phenomenon. Darwin (*Animals and Plants under Domestication*, chapter xii.) cites an English

family in which "for many generations some members had a single lock differently coloured from the rest of the hair," and an Irish family in which a small white lock occurred in son, mother, and grandmother.

Cockayne (1914) states that piebalds are very uncommon both in black and white races. He describes a piebald English family of six generations with nineteen affected members, belonging to a farming stock near Bury St. Edmunds, Suffolk. Some members of the family are fair and some dark, but both inherit the peculiarity, which consists of a blaze in the forehead. Three members of this family have heterochromidia iridis, and some have additional white patches of skin on the body. In the last four generations of affected families the total numbers are seventeen having the flare to twelve* normal. This is near enough to the equality which would be expected if the flare were a heterozygous dominant condition, and is in general accord with Pearson's case, but the excess is on the other side and is, perhaps, not significant in either case. We may, then, conclude that the flare behaves as a simple dominant, at least in these three independent families, and in the two described in the following paragraphs.

A family with a white forelock occurring in four generations has been described by Holmes and Schofield (1917). This lock occurs in the centre of the fore part of the scalp, the region affected being quite small (size of a florin). Heterozygous females do not show the mark. It would appear that the character behaves as a dominant in males and as a recessive in females (see Fig. 11), like the inheritance of horns in crosses of a breed of sheep in which only the males have horns with one in which both sexes are hornless. In a white forelock family, described by Pearson, Nettleship, and Usher in the monograph on albinism

* One of these is doubtful.

in man, the white lock occurred only in males, but was transmitted through females, skipping a generation in each case.

A much more interesting and extensive pedigree of a white lock family is given by Miller (1915). In this family the condition has been traced through six generations, including 203 individuals. Dr. W. B. Little, whose mother is known to have had the lock, emigrated from Carlisle, England, to New Brunswick, Canada, about 1824, and his descendants through four generations show the white lock or flare. Some members of the family also have one or more colourless spots on their bodies. The condition behaves as a simple dominant, since in families with one normal

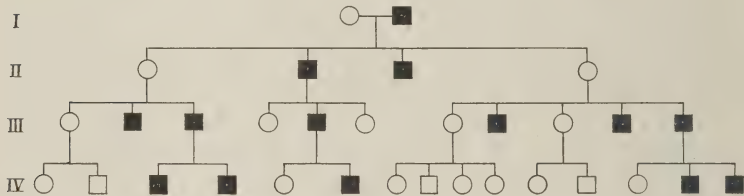

FIG. II.—FAMILY SHOWING A WHITE FORELOCK.

and one marked parent the numbers were fifty-one normal and forty-five with the flare (where equality would be expected); and where both parents are normal all the children are the same. This family traces its origin back through the Percys and Mortimers to Edward III. That the white lock is, at least, as old as the family of Harry (Hotspur) Percy is known by the tradition that the white lock originated in connection with his death at the battle of Shrewsbury in 1403. When the news of his death reached his wife, she is said to have swooned and to have given birth shortly afterwards to a son bearing a white patch on his forehead. One member of the family has found from other records that the patch

goes back at least to the Percys. It happens, also, that Lady Percy was an albino. The white flare may therefore, possibly, have originated with her, for although no such case is on record, it is known (see next paragraph) that spotted mulattoes arise from an ancestry in which different types of skin pigmentation have been involved.

Another interesting case, first recorded by Simpson and Castle (1913), is of spotting arising in a coloured race. It originated as a novelty—a spotted woman born from ordinary mulatto parents in Louisiana in 1853. No case of spotting had previously been known in that part of the country. She married a normal black negro, and their children numbered fifteen, eight spotted like the mother, and seven normal, but varying in depth of colour as is usual with mulattoes. Three of the normal children and three spotted married normal negro mates. The normals had in all seven children, all normal. The spotted had in all nine spotted and two normal. This indicates that all the spotted individuals, male and female, behaved as heterozygotes, and that complete segregation occurs between spotting and non-spotting. The fact that spotting appears rarely and sporadically among the innumerable mulatto crosses tells strongly against it being the result of an inherited spotting factor. The particularly clear evidence here indicates that it arises as a mutation in the hybrid stock, the original spotted individual being heterozygous and the piebald condition dominant to normal mulatto pigmentation.

With regard to the ancestral colour of man, it seems clear that the most primitive races were black (as John Hunter concluded 150 years ago), or at any rate dark, as they are now, and that the white race arose from them with loss of pigmentation. It appears unlikely that a simple mutation was involved.

Although albino mutations occur in black races, the "white" man is by no means devoid of pigmentation. It appears probable that many small germinal changes affecting pigmentation were involved. The known relations between skin pigmentation and the adrenal capsules indicate that germinal changes which affected the activity of these glands were really involved. From recent studies of the endocrine gland secretions, it appears that differences in the activities of various endocrine glands are responsible not only for the differences in pigmentation of the various races of mankind, but also for their characteristic physiognomies (see p. 211 *ff.*).

In the same way, it is highly probable that brown was the primitive eye colour in man, and that blue arose from it through one or more mutations, with loss of pigment. (For a further discussion of this subject see p. 44.) It may be that blue arose originally as a simple mutation from brown, and that intermediate shades have come in later. This has been shown to be the history of various cases of melanism in *Lepidoptera*. But at present there is no definite evidence to prove the point either way as regards man. When blue eyes were once established, they multiplied in the northern races, perhaps through sexual selection, until blue eyes are characteristic of the Scandinavian and other northern peoples. But the native peoples in tropical countries appear always to have retained brown eyes, the pigment probably being a protection for the eye against the strong rays of the sun. The white race is thus in a sense an albinotic variation, which has arisen through loss of pigmentation. This loss has been carried still further in the more northern races with fair complexion, light hair, and blue eyes.

In the Pearson monograph on albinism many early records of albinotics are considered. It is concluded

that there is no evidence that a tribe or clan of albinotics ever existed, but there are numerous records indicating the existence of considerable numbers of albino individuals. In connection with Dampier's expedition to Darien in 1681, there is a long and circumstantial account of the "white Indians," who could see better by moonlight, etc. There is a similar record for Brazil in 1775. Cortez, in connection with the Spanish conquest of Mexico, described Montezuma's palace as containing an entourage of albinos. In a similar way, in the Middle Ages, fools and dwarfs were considered a desirable accessory to the retinue of kings and nobles. As late as 1841 Catlin described a "white Indian tribe" in Upper Missouri containing many albinos. It appears that albinism is now most frequent among the Indians of Arizona and Mexico. Poole, in 1872, reported light-haired and fair Indians from Queen Charlotte Islands and British Columbia. Newspaper descriptions led to a belief in a colony of albinos living in "the forest country" back of Cape Cod, Massachusetts, but Pearson could get no definite confirmation that such a group ever existed, although it may have had some basis in fact.

Albinism is known in most races and probably occurs in all. Its frequency is unknown, but is estimated at, perhaps, 1 in 5,000 or 1 in 30,000. In Germany, out of nearly four million children dealt with, about 400 had "white hair." This would give a frequency of 1 in 10,000. A similar proportion was found in Norway. Of the 400 only 32 had "red eyes," and of these only 23 had also white hair: hence only one complete albino in 200,000, but the true prevalence may be greater. In Austria, from statistics of insane albinotics, it was estimated that 1 in 400, or 1 in 2,000, of the population were albinotics. This very high estimate is probably due

to correlation between albinism and mental derangement.

In Scotland 100 to 150 living albinos were recorded from about half the population. This indicates a frequency of 1 in every 15,000 to 25,000 inhabitants. Moreover, less satisfactory records are available from many other countries and races. It appears that albinism occurs as a mutation in the absence of crossing of races, both in the dark and white races, but it also frequently arises, as we have seen, a generation or two after a mixture of races has taken place. The piebald, apparently arising only from cross-breeds, is far rarer than the complete albino.

Pearson also considers the pathological condition known as leucoderma (white patches on the skin), and finds there is no physiological differentiation from albinism, the two being distinguishable only by the inheritance of the latter. Pearson distinguishes between spotlings and piebalds, the former including those with white markings which do not extend to extensive areas on the trunk. The extent of the leucosis is probably hereditary, but there is no sharp line between spotlings and piebalds. The spotling of one generation may be the father of a piebald in the next. Albinism, piebaldism, and leucoderma are probably all to be accounted for by the same metabolic defect. Leucoderma, however, is not necessarily inherited.

A family in which albinism was carried as a recessive for five generations is described by Sedgwick (1861). The pedigree of this family is given in Fig. 12. One of the original great-grandparents must have been carrying albinism as a recessive. The wife of No. II. 1 must have been in the same condition. Their daughter, Josephine (III. 1), was the only descendant of this son to show albinism. The two grandsons, III. 2 and III. 3, married sisters,

both of whom evidently carried albinism recessive. No. III. 3 had seven normal sons, five of whom married, but only one of them had albino children. This family numbered three normal sons, and nine daughters, four of whom were albinos. The mother again must have carried albinism as well as the father, if the condition is, as usual, a strict recessive (see p. 70).

In another record of Sedgwick, two grandsons in a Swiss village had each two daughters, one normal and one albino. The albino great-granddaughters married. One had no children, the other had an

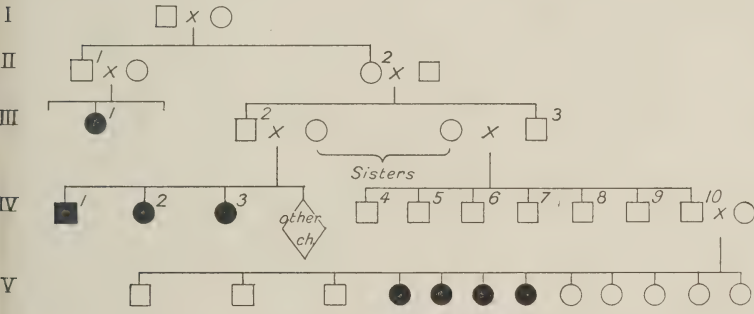

FIG. 12.—PEDIGREE OF ALBINISM IN A FAMILY.

imperfect albino by a husband with black hair and brown eyes. There was probably intermarriage in both these lines of descent.

Little (1920) mentions that a piebald coat characterises such breeds of dogs as foxhounds, beagles, Boston terriers, St. Bernards, and collies. The spotting reaches an extreme in bull terriers where normally only the eyes are pigmented. The origin of spotted individuals from typical ancestors is recorded in two pure breeds of pedigree dogs, and it is considered that they may have arisen through mutations. In the first a spotted female was born from two solid-coloured pedigreed and registered

Scottish terriers, but since a certain dog occurs in both the male and female ancestral lines the outcrop of spotting would be accounted for if that animal were carrying a recessive factor for spotting. In the other case, four spotted puppies occurred in two litters of pedigree Airedale terriers. The pedigree of the five previous generations shows that one male occurred seven times and one female three times in this pedigree, the former occurring on both sides of each ancestral line. He was probably carrying a recessive factor for spotting, or possibly a mutation giving rise to this factor took place in his gametes.

The writer (Gates, 1909a) found in a cross between a pure-bred Old English sheep dog and a Scotch collie that F_1 dogs were produced with several different lengths of tail, or no tail, like the mother, and with many other differences in coat, build, and temperament. It is probable that almost all our pedigree breeds of domestic animals carry some recessive characters, which have never been eliminated since the original crosses, which in many cases were the foundation of the breed. But these germinal differences must have arisen at some time through germinal changes which gave rise to the parental types, although similar germinal changes may equally well occur afterwards and be carried as recessives in the germ plasm until a cross or inbreeding brings them out.

The Pearson monograph includes also a study of peculiarities of vision, such as night-blindness, as well as the hair, of albinotics, and also albinism in various animals. Complete albinos with pink eyes are known to occur in "pure" races of man, just as they occur in many mammals,* birds, and plants

* There are records, for example, of albino beavers, chipmunks (*Tamias*), squirrels, woodchucks (*Arctomys*), robins (*Turdus migratorius*) and sparrows. Dean (1903) says: "True albinos occur among hag-fishes, and partial albinos are not rare."

(white petals). The monograph above mentioned also includes a study of seasonal variation in animals that are white in winter, such as *Lepus variabilis* in Scotland. Crosses of white and black Pekinese dogs are also believed to furnish evidence of the *de novo* origin of spotting and blends. It is well known, of course, that in certain breeds, as the Dalmatian, particular types of spotting have become a fixed characteristic of the breed. Numerous Mendelian studies of spotting in mammals have been made in recent years, especially in rabbits, rats, and mice, and complicated theories of inheritance of spotting have been formulated. The subject is complex and far from settled, but it seems clear that in many cases degrees of spotting and their inheritance can be explained on the basis of a series of factors for spotting. The evidence clearly indicates, I think, the sporadic *de novo* origin of spotting in man, but it does not follow that the same is necessarily true for dogs. In some breeds spotting, however attained, has the status of a germinal factor, and the regularity with which white-black crosses of Pekinese yield definite patterns would seem to indicate another mode of heredity behaviour—*i.e.*, that a spotting or pattern factor is present in these crosses.

Detlefson (1920) has described a herd of albino cattle on a farm in Minnesota with several points of interest. This herd originated from two albino calves—a bull and a heifer—which resulted from mating a “full-blooded” Holstein bull with “grade” Holstein cows. The parents had the normal black-and-white spotted coat colour, while the calves were

Standley (1921) refers to an early American record of an albino black bear with “four cubs, one white, with red eyes and red nails, like herself,” showing that albinism must have been carried as a recessive in the strain.

pure white with pink eyes. The original bull produced these two albinos out of matings with about twenty grade Holstein cows, the remaining calves being normal. Unfortunately the original records of the herd were destroyed by fire, for the later breeding behaviour of these two albinos is peculiar. From its manner of origin one would expect the albinism to be present as a recessive character in the germ plasm of this herd. But the young albino bull mated to grade Holstein cows produced only albino offspring—about twenty in number. The albinos mated *inter se*, moreover, produced only albinos, and four albino cows mated to a registered Holstein bull (the original bull had been killed) produced three albinos and one normal. It is not certain from these later matings that the albinism behaved as a simple dominant, for there is no record of coloured offspring from two albino parents. But, at any rate, the later hereditary behaviour is different from that at the time of its original appearance as a mutation, and it is not clear that this change in behaviour can be explained merely as a reversal of dominance.

The albinos showed no pigment in the skin, eyes, horns, or hoofs, except in one cow which had a small black spot about one centimetre square in one ear. There was no alteration in milk-production, but the albinos were extremely sensitive to light, and grazed listlessly during the day with partly closed eyes. Such albinos are, of course, quite different from the famous Chillingham and Chartley herds and other races of white cattle. The evidence indicates that in these the white is a dominant, and that they are descended from original prehistoric wild white cattle in Britain (see Storer, 1881, and MacDonald and Sinclair, 1882). They are not pure white, but had typically black hoofs and muzzle, a circle round the eyes, black tips to the horns, and in some cases a black tip

to the tail. Wild white cattle from Thessaly, etc., were also known to the Greeks and Romans, and in Italy a white breed, in which the calves are yellowish, continues down to the present time.

Three types of albino horses have recently been described (Wriedt, 1918) in two Norwegian breeds. The heterozygous condition is intermediate in these horses, and albinism appears to behave nearly the same as in guinea-pigs.

Civilisation has often been credited with the production of the numerous congenital deformities that appear in man. But various studies, such as that of Stannus (1914) on the Bantus of Nyasaland, show that the same abnormalities continue to appear, probably with equal frequency, in native races, even though the more marked of them are ruthlessly eliminated by infanticide. It is evident that the conditions of civilisation tend rather to preserve than to originate abnormalities, and that natural selection in native races, as in wild animals, combined with parental selection, tends to eliminate individuals possessing characters which place them at a disadvantage in the struggle for existence.

A short account is published (Thadani, 1921) of a Hindu Amil community in India, in which a toothless type of man occurs. The men are not only toothless, but bald-headed and extremely sensitive to heat. The evidence, so far as it goes, indicates that the character is sex-linked. Anodont females are not at present known, but if daughters of a toothless father are married to a normal man, their male children are toothless (*Bhudas*).

LEFT-HANDEDNESS.

Another innocuous feature whose inheritance is well known is left-handedness, which the results of Jordan (1911) and of Hurst (1912) indicate is inherited

as a simple Mendelian recessive character, at least in some families. Ramaley (1913) came to the same conclusion, based on 1,740 cases. He estimated that the condition is carried in about one-sixth of the population. Left-handedness, as a character, may bear some resemblance to reversed symmetry in certain Gastropods. This reversal has been shown by Conklin to begin in development with the cleavage of the egg, the spiral cleavage being dextral in one case and sinistral in the other, but its inheritance is unknown. Ambidextrous individuals in man appear to have inherited left-handedness and acquired dexterity with the right hand. There are apparent exceptions, however (see Compton, 1912, where a number of references will be found), as in a family quoted by D. J. Cunningham in the *Journal of the Anthropological Institute*, xxxii., 1902, from Aimé Péré, where a left-handed mother and a right-handed father had eight sons and six daughters, all left-handed. If the father were heterozygous, this result would be possible, though very improbable, even if left-handedness were regarded as a recessive. It would seem more probable that in such a case the dominance has been reversed. There is also clear evidence that in certain families the condition is sex-linked.

A recent paper by Beeley (1920) considers left-handedness from various points of view, and gives a number of references to the literature of the subject. Estimates of the frequency of left-handedness have varied between 6 and 2 per cent., with 4 per cent. as the medium frequency. This applies to American Indians (Apaches and Pimas), as well as to white races. That the condition is more frequent in man than in woman has been affirmed and denied. Some have found it more frequent among delinquents and among negroes, but there seems to be no sufficient

basis for these conclusions. Jordan, from an examination of 700 university students, 1,394 coloured school children, and 668 others, concludes that the condition is inherited, but is not very clear that it follows Mendelian principles. Baldwin found that the tendency to use one hand more than the other developed about the seventh month after birth, when all influences to the greater use of one hand were eliminated. The old idea that right-handedness was developed because warriors held the shield with their left hand to protect their heart and wielded the spear with their right will not bear analysis with modern conceptions. That right- or left-handedness does not depend on a difference in the eyes is also shown by the fact that there is the same proportion of left-handed among the congenitally blind as among those who use their eyes.

Beeley considers the results from 106,356 children examined, and concludes that all degrees exist from extreme left-handedness to extreme right-handedness. Among this number of children were found forty-two "mirror-writers." The results showed that mirror-writing is not necessarily correlated with mental deficiency, but rather it is characteristic of extreme left-handedness. A method was devised for measuring the degree of left-handedness by means of a brass plate divided into squares, on which two straight lines at right angles to each other were to be traced. The squares were alternately insulated in such a way that every error produced an electric current which was recorded in a counter. The number of errors in tracing the two lines, multiplied by the time taken, was used as a measure of the degree of left-handedness. Obviously general dexterity would play an important part in a result of this kind, and the age of the child would be an important element in such a result. It is not, therefore, clear that the degree

of left-handedness forms such a continuous series as these results would indicate, although it is highly probable, if not certain, that degrees of left-handedness exist. Beeley suggests that a slightly left-handed child should be taught to use its right, but that an extreme left-hander should not.

That the right hemisphere of the brain controls the left side of the body and *vice versa* is, of course, well known; also that the development of the speech-centre may be interfered with by a too early attempt to teach a left-handed child to use its right hand, thus leading to stuttering.

The manner of clasping the hands, whether right-handed or left-handed—*i.e.*, with the right thumb over the left or *vice versa*—although characteristic enough for the individual, apparently bears no relation to right or left-handedness. It does not follow any known rule of inheritance, but appears, nevertheless, to be partially inherited, for when both parents show a right- or left-handed clasp the majority of the children will be of the same type. Statistics show that *en masse* the two methods usually occur with equal frequency, but neither condition breeds true. Compton (1912) has studied the right and left-handed seedlings (as regards the manner of folding of the first leaf), which occur in various cereals, but the condition is not inherited. Thus the seeds from a left-handed (LH) plant produce the same ratio of LH and RH plants as do the seeds of a right-handed (RH) plant. In two-rowed barley this ratio LH/RH was shown to be constant for three generations, and therefore inherited. In a total of 19,165 seedlings, the percentage of LH seedlings = 58.362. Seeds planted from the odd and even rows separately also gave the same preponderance of left-handed plants. Six-rowed barley gave a similar excess of LH plants. In oats, however, there is regularly an

excess of RH plants (LH=44.88 per cent.). This difference may have some connection with the fact that the leaf-blades of barley "are generally slightly twisted into a right-handed screw, while in oats the torsion is in the reverse direction." In maize, again, there is no inheritance of left-handedness or right-handedness as such, but the seeds in odd rows give an excess of RH, those from even rows an equal excess of LH seedlings. The ratios were 54.22 per cent. and 46.16 per cent. LH respectively. Thus, the total numbers of LH and RH seedlings from a cob are practically equal. Compton suggests that the differences between rows in this regard may perhaps be accounted for by unequal pressure on the embryos. In any case it is a relief to find something which is definitely not inherited. The question of the limits of human inheritance will be discussed in a later chapter.

In 1908 a list of normal and abnormal features in man, whose inheritance had been studied, was published by Hurst, and Bateson (1909) devoted a chapter to this subject. Davenport (1912) also considered many cases, and *Biometrika* contains masses of statistical data on the inheritance of various features. Abnormalities are frequently inherited as dominants, and they probably originated as mutations. Such are hexadactyly, brachydactyly, "lobster claw," some forms of cataract, keratosis, congenital stationary night-blindness (in certain families), and many others. Brittleness of bones or osteopsathyrosis (Conard and Davenport, 1915) is a remarkable congenital weakness which appears to be inherited as a dominant character. In one recorded case a boy suffered at least twelve fractures of his limbs before reaching the age of three years, being born with both thighs broken. Later this extreme liability to fracture began to diminish, but that it may still remain a serious defect in the

adult is shown by the fact that the mere tension of the muscles or weight of the body, as in dancing, may be sufficient to cause a fracture. Twins may be born in families having the peculiarity, one showing the defect and the other normal. Sedgwick (1863) cites a family from Dr. Pauli with a less extreme form of the condition, in which the brittleness was confined to the bones of the upper extremities. It occurred in three generations.

DIGITAL ABNORMALITIES.

We may now consider some of the digital peculiarities whose inheritance has been studied in man. A very good case is that of split hand and foot, or "lobster claw." Lewis and Embleton (1908) consider a collection of 180 cases of this deformity. They find it by no means uncommon. Many varieties of the condition occur. In the "G" family, to which many of their data refer, the hands are variously misshapen, and each foot consists of two toes separated by a deep cleft. Rarely the toe on one side may be double, and the toes are generally bent claw-wise at their extremities. Both the hands and feet of these people are said to have great functional capacity and accuracy in use, including needlework and handwriting. The variations in the deformity are only in degree. Rarely one or both hands may be normal when the feet are split. The condition may also be associated with syndactyly (fused fingers) or polydactyly (extra fingers or toes). Cross bones frequently occur in the hands, but never in the feet. The inheritance is essentially that of a Mendelian dominant, though the expected ratios are not always adhered to.

In the "G" family this condition has been traced through five generations. It never skips a generation,

and derived normals \times normals give only normal offspring. It is transmitted equally through either sex. In the offspring of crosses between deformed and normals, Lewis and Embleton find a total of forty-four deformed to thirty-two normal. In some, though not all, of the other data of inheritance of split foot, they find a similar excess of deformed individuals, which appears to be significant. It does not necessarily follow that the condition is not represented by a single difference in the germ plasm. Indeed, they agree that it has arisen as a "sport" or mutation of germinal origin. They state "there are records of over thirty instances of the origin of this same sport," and account for this by the now widely accepted view that mutations tend to occur and recur in definite directions. Since the character is dominant it cannot remain hidden in the germ plasm, but must appear externally if the germ cell containing it develops into an individual.

All writers agree that this character segregates sharply, but they claim that it "does not follow the laws of Mendel," because of the excess of abnormals in the offspring of crosses with normals. This does not necessarily follow, for it is now known that many physiological and environmental conditions may cause distortion of Mendelian ratios. Lewis and Embleton believe there is a "decided tendency for the deformity to die out" in later generations. They appear to think that this results from the germinal condition representing split-foot becoming unstable. Perhaps the struggle for existence has something to do with it, as well as sexual selection.

Pearson (1908) refers to the evidence for the existence in Scotland of a family, "the Cleppie Bells," with a deformed hand inheritance extending over two centuries. He traces the deformity in another family for four generations, and finds again an excess

est

of abnormals in the offspring of crosses with normals (25:14). He concludes, "on the whole, while these cases give very definite evidence of the segregation factor, they do not seem to me to favour the segregation in rigid Mendelian proportions." The stock of this family is otherwise normal, and they have no difficulty in finding normal mates. The gait is ungainly, but the children at school hold their own in writing, drawing, and needlework. Additional data for this family are given by McMullen and Pearson (1913), the numbers of abnormals recorded having increased from twenty-five to thirty-three. In the third generation the result is in conformity with the Mendelian expectation of equality of normals and abnormals. In the fourth and fifth generations there is a total of twenty-eight affected to thirteen normal. Everything considered, it seems most reasonable to regard the condition as due to a single Mendelian dominant factor which arises from time to time as a mutation, but which, through increased viability or for some other reason, occurs in more than 50 per cent. of the offspring from crosses with the normal. Lewis (1909*a*) records certain other split-foot pedigrees. The only facts that need specially concern us are: (1) a family of ten, in which half are abnormal and half normal; (2) a family of six, all abnormal. In the latter the father may perhaps have been homozygous.

Brachydactyly is an abnormality which has been even more studied in recent years, although it is probably much less frequent in its occurrence than split-foot. The condition is illustrated in Fig. 13, which shows normal and brachydactylous hands for comparison, and Fig. 14, which is a radiogram showing the bones of a brachydactylous hand. The earliest study of the inheritance of brachydactyly was by Farabee (1905) in an American family from

Pennsylvania. He shows that the condition was inherited as a simple Mendelian dominant, the offspring of the affected mated with normal giving 50 per cent. of each type (thirty-six affected, thirty-three normal). Brachydactylous women cannot play the piano well owing to their inability to span the octave. Brachydactylous men in this family include farmers, mechanics, business men, and school teachers. One was head of a commercial school and a fine pen-



FIG. 13.—BRACHYDACTYLOUS AND NORMAL HANDS FOR COMPARISON. (After Drinkwater.)

man, another was a baseball catcher. The arms and legs are short, but the sitting height is nearly normal, and abnormals are stouter than their normal sibs.* There is an unverified tradition in the family that the first member with short fingers came from Normandy in the army of William the Conqueror. Brachydactylous individuals have never intermarried; but the abnormals always marry first, and will soon have gained a generation in this way. This was the

* That is, brothers and sisters.

first case of Mendelian inheritance demonstrated in man.

Drinkwater (1908) independently investigated a British family, with the same results as regards inheritance. He found that the strength of grip in brachydactyloous individuals was considerably below



FIG. 14.—RADIOGRAM OF A BRACHYDACTYLOUS HAND, SHOWING THE TWO PHALANGES IN EACH FINGER. (After Drinkwater.)

the average. They complain that they cannot play the piano or any other musical instrument requiring normal length of fingers, their grasp of objects is smaller than normal, and the women cannot do netting. That they are handicapped is shown by the fact that their social position is lower than that of

their normal relatives. They are engaged in unskilled labour, while their normal relatives include farmers, grocers, etc. In a wild tribe where personal defence with weapons is a necessity, brachydactylous individuals would probably not survive.

In several papers Drinkwater has made a careful anatomical investigation of brachydactylous hands and feet, including radiographic studies. The condition applies equally to fingers and toes, and is accompanied by short stature. In the digits he showed that the middle phalanx is very short, and has become ankylosed to the base of the terminal phalanx. Hence the second phalanx is rudimentary, and at a certain stage of development it unites with the terminal phalanx. The most important feature is the absence of the epiphysis (terminal cartilage, which becomes ossified) at the base of the second phalanx. The epiphysis may also, perhaps, be missing in some cases from the third phalanx, the second and third phalanges consisting at first of a single piece of cartilage. The metacarpal (wrist) bones are also more or less abnormal, but the metatarsal (instep) bones are unaffected. This abnormal family was very prolific, the number of children in nine families averaging eleven each. A normal woman had forty-five descendants, while a brachydactylous woman in the same family had ninety-nine descendants. The numbers in successive generations show that the condition is on the increase, and that there is no chance of it becoming extinct so long as the brachydactylous members continue to marry. For some unknown reason they do marry more frequently than their normal sisters.

The essential feature in brachydactyly is, then, the absence of the epiphysis at the base of the second phalanx, with subsequent ankylosis of the second and third phalanges. The fingers are about half the

normal length. Although brachydactylous individuals are lacking in some forms of dexterity, and therefore must accept a lower social status, yet they show a decided increase in fecundity compared with normal members of the same family. In this family twenty-five now living in England and Wales are brachydactylous. Beginning with the fourth generation, the total number of descendants from DR \times RR* crosses is seventy-five, of whom thirty-nine are abnormal.

No connection could be traced between Drinkwater's first brachydactylous family and the one described by Farabee, there being no surname common to the two families. Drinkwater (1915) has since described another family, however, which he has shown to be descended from a member of Farabee's family, who removed from America and settled in this country. In this family and its American antecedents the abnormality can be traced for six generations. In both branches of this family the proportion of females among the abnormal is exactly 61 per cent. In the English branch fifty abnormal were recorded to forty-eight normals, where 50 per cent. of each type were expected, showing that heterozygous brachydactyls produce the two types of germ cells in equal numbers. Normals mated together invariably have only normal offspring. The shortness of stature of brachydactyls is shown to be due to the short legs, both femur and tibia being shorter than in normal members of the family.

Drinkwater has also described in two families the condition which he calls minor brachydactyly (1912, 1914). In a Lancashire family this abnormality has been traced through five generations, and sixteen abnormal were living when the study was made. The fingers are less shortened than in brachydactyly,

* D=dominant, R=recessive, hence DR is a heterozygous dominant.

but the middle phalanx of each finger is abnormally short. This is partly due to the absence of the epiphysis from the base of the second phalanx, except in the thumb and middle finger, and also to a slight shortening of the second phalanx, but is chiefly due to the fact that the cartilage between the shaft and the epiphysis becomes prematurely ossified, thus causing cessation of growth in length of the fingers at an early age. Ankylosis of the epiphysis and the second phalanx frequently occurs earlier in the first and fourth fingers than in the second and third, thus leading to a greater shortening of the former. The abnormality of the toes is practically identical with that in ordinary brachydactyly. This family is also shorter in stature. As in the brachydactylous family, the women are $4\frac{3}{4}$ inches and the men 8 inches shorter than their normal siblings. A total of twenty-one abnormal to twenty-six normals were recorded in families having one abnormal parent. The abnormal in this family are said to have better health than the normals. In the children the abnormality is inconspicuous, and is sometimes detected only by flexing the finger.

In the second family showing minor-brachydactyly (Drinkwater, 1914), the conditions closely resemble those in the previous family, but so far as the records go back there is no connection. It is found in five generations, there being nine abnormal to ten normals, eight of the former now living. They are all descended from an illegitimate daughter of a short-fingered man, the mother having been married to a normal man by whom she had entirely normal descendants. These forms of brachydactyly are, therefore, all simple Mendelian dominants like split-foot, but they show no appreciable excess of abnormal in inheritance, and they show a clear tendency to increase rather than die out, notwithstanding their social handicap,

or possibly on account of it. Bateson, who discussed the earlier records of brachydactyly (1909, p. 210), refers to a four-generation pedigree, described by Walker, of what appears to be a mild form of minor-brachydactyly inherited in the same way.

Lewis (1909c), in a thesaurus of the results of the study of brachydactyly, up to the time his paper appeared, cites two other cases with interesting



FIG. 15.—HAND SHOWING ABNORMAL SEGMENTATION OF THE INDEX AND MIDDLE FINGERS. (After Drinkwater.)

features. In Mercier's case a French family is described in which eighteen members in three generations are brachydactyl, having two phalanges on all the fingers and toes. Hasselwander's case (a German family) presents a feature of special interest. There were six abnormal members of the family in three generations. The original brachydactyl of this pedigree came from normal parents. His advent must, then, mark an independent origin of

the condition through a mutation, unless possibly his affected parent only had the condition in a slight degree, and so was mistaken for a normal. The actual origin of such a case is naturally difficult to prove, and this can only be done where the conditions in both parents and grandparents are accurately and certainly known from observation to be normal.



FIG. 16.—RADIOGRAPH OF THE TWO HANDS OF A GIRL AGED NINETEEN, IN THE SAME FAMILY AS FIG. 15. (After Drinkwater.)

That various other modifications of typical brachydactyly, in addition to those described above, are inherited in the same way is shown by such records as those recently published by Dr. Drinkwater (1916), whose accurate work in recording these cases is of great value. He traces through four generations a case of abnormal segmentation of the index and middle fingers, the third finger being much longer than any

of the others owing to the great length of its proximal phalanx. The first and second fingers are also more or less tilted away from the thumb (see Figs. 15 and 16). There are thirty-six descendants of the abnormal members of the family, fifteen of whom show the abnormality. The feet in these individuals show ordinary brachydactyly. From a careful study of radiographs the following anatomical interpretation emerges: The index finger has at its base an extra triangular bone which sets the finger obliquely to the hand. The proximal phalanx of the middle finger appears to be divided equally or unequally into two parts; the lower part, however, is probably an extra bone corresponding to that in the index finger, and it also is set somewhat obliquely. In the adult hand these extra bones become ossified with the proximal phalanx of the corresponding finger. Another peculiarity in this pedigree is the abnormally great length of the proximal phalanx of the ring finger. All these anatomical features behave as a unit in inheritance, with remarkably little variation in their development so far as observed.

Drinkwater (1917) has described yet another digital abnormality, which is remarkable for the number of generations for which it is known to have been handed down in one family. The peculiarity is as follows, as found in the hands of a gentleman, A. T., of the present generation: In the middle finger the joint between the middle and basal phalanges is only very slightly movable, the articular surfaces of the bones being enlarged, while in the ring and little fingers there is no joint between the proximal and middle phalanges, these two being completely fused into one (see Fig. 17). All the fingers are movable at the distal joint, and both hands are alike. All the toes, except the hallux, are affected exactly like the ring and little fingers. This man's father and *his*

mother are known to have had precisely the same abnormality. His father married twice, and one of the half-brothers shows it. The most interesting feature of this case is that A. T. is a direct descendant in the male line from John Talbot, the first Earl of Shrewsbury, who figures in Shakespeare's *Henry VI.*,



FIG. 17.—SKIAGRAM (PHOTOGRAPH BY RÖNTGEN RAYS) OF THE HANDS OF A. T., SHOWING CONTINUITY OF THE PROXIMAL AND MIDDLE PHALANGES IN THE RING AND LITTLE FINGERS. (After Drinkwater.)

and was killed in battle near Bordeaux in 1453. Tradition has it that his thigh bone was broken while on horseback, and that when he fell from his horse he was killed by the blow of a battleaxe on the head. His body was buried in a tomb inside the church at Whitchurch, which was surmounted by a

stone effigy. In 1874 the tomb was opened and repaired by one of his descendants. The skeleton was identified by the cleft skull and the fracture of the right thigh bone. The finger bones, when examined, showed the same ankylosis that exists in his modern descendant. On the stone effigy the fingers, which were somewhat damaged, also showed precisely the same thickening of the middle joint as described in his descendant. Clearly, then, this defect has been handed down for more than 500 years as a Mendelian dominant, and the genealogy of the family shows that it must have been inherited through fourteen generations. This, I believe, is the longest period on record for the tracing of an anatomical abnormality in man, though the Hapsburg jaw extends back equally far.

In America, Cushing (1916) has described essentially the same condition, but no connection with the English family can be traced. The condition in this family closely resembles, or is identical with, that in Walker's Maryland family (see p. 84), though no relationship between them has been traced (see also p. 82). They are commonly spoken of as "straight-fingered," because the fingers can only be partly closed on the palm. There is complete absence of the proximal joint in all except the index fingers, in which there is a trace of a joint. In this finger slight movement is possible, but the middle phalanx is very short. The greater effect on the middle phalanges is true also of Drinkwater's minor-brachydactyly, and is probably due to the fact that the ossification centres appear later in this phalangeal row, this being the last row to ossify and the terminal row the first. The toes are likewise affected, even occasionally, as in "lobster claw," when the hands appear normal. It is quite probable, according to Cushing, that the articulations between the proximal and middle rows of phalanges are the last to be laid down, and that

“an inhibitory influence checks their development at a stage a few days later than that which checks the formation of the ossification centres and produces brachydactyly.” Hence both are conditions of arrested development in different degree.

The original member of this “straight-fingered” family, William B., migrated from Scotland to Virginia in 1700. He married, and from him are descended seven generations, most of whom still live in the same region of Virginia. A member of the fifth generation has communicated with a Scottish relative who shows the trait. The inheritance is that of a Mendelian dominant, the family including 452 individuals in eight generations. Of the 150 children of an affected parent in twenty-eight completed families, seventy-eight of them, or 52 per cent., carried the trait. There is considerable variation in the expression of the character, and the trait may be transmitted in extreme form by a parent who appears to be but slightly affected. In one case a woman who was doubtfully abnormal, but transmitted the trait, was shown by radiogram to have the condition only on the little finger of one hand.

Another family with the same peculiarity of fingers, which cannot be flexed properly, is described by Duncan (1917). It is perhaps related to Cushing’s family, since its ancestors are said also to have come from Scotland. The second joints of the fingers, and frequently also of the toes, are perfectly inflexible. The character is a Mendelian dominant and is traced through four generations, the original affected parent (male) being apparently heterozygous.

Another pedigree of a short-fingered family is given by Mohr and Wriedt (1919), who review the literature of brachydactyly. The case they describe, with numerous photographs and radiographs, is of a Norwegian family, some of whose members migrated

to North America. The malformation consists in a shortening of the second phalanx of the second fingers and toes only, and is called brachyphalangy. There is no shortening of the stature. The condition occurs in two degrees: (1) so slight as to be often overlooked or even invisible; (2) more extreme, probably due to the presence of a modifying or intensifying factor. The inheritance is that of a simple Mendelian dominant. It has been traced through five generations of descendants from a brachyphalangous woman born in Norway in 1764. Detailed knowledge of the earlier generations is obtained from a carefully kept "family book." In two lines descended from an affected daughter and an affected son of this woman, every individual is recorded. In one case intermarriage within affected lines apparently produced an individual homozygous for the character. She was a cripple without fingers or toes, and died at the age of one year, being unable to develop. This shows how serious even a slight abnormality may become if present in the homozygous condition. It corresponds with many of the lethal factors known in *Drosophila*. The writers refer to Mackinder's (1857) record of a family, in which brachyphalangy combined with hypophalangy (less than five fingers) was transmitted for six generations in the manner typical for a Mendelian dominant character. This was in 1857, before even Mendel's original work was done.

Cragg and Drinkwater (1916) describe a much more extreme case, which Mohr and Wriedt refer to as hypophalangy combined with brachyphalangy. There is an entire absence of the distal phalanges from all digits except the thumb and big toe, and an extremely abortive condition of the middle phalanx in the same digits. Nails are absent. The condition was traced as a Mendelian dominant through

five generations, including twenty-seven affected individuals. In six of these there was also a bifurcation of the thumbs, which may be due to the presence of a dominant modifying factor. Wegelin (1917) traces through three generations an abnormality affecting only the little fingers. The terminal phalanx is bent to the radial side, the middle phalanx shortened, and its distal end oblique. It is dominant, but there were fourteen abnormal to two normal in the third generation.

The remarkable accuracy of the inheritance of many digital malformations is shown incidentally by a paternity case (Mohr, 1921), in which the alleged father had a pronounced brachyphalangy affecting the second row of phalanges on fingers and toes II, III, and IV. The thumbs were normal, but the basal phalanx of the great toe was shortened. The hands and feet of the child showed exactly the same malformation, and radiographs indicated absolute correspondence in the bones. The man was therefore adjudged to be the father.

There is an early record* of a peculiar form of brachydactyly in which the mother and two children, who were examined at Uxbridge, had normal thumbs, but the fingers had only one phalanx each, except the ring finger of the left hand, which had two phalanges. There were no nails on these fingers. All the rest of the family were said to be the same, and the condition was stated to have been inherited for nine *previous* generations, but there are no records to substantiate these statements. The character was only transmitted by the women, who sometimes had a child with perfect fingers.

In another case (Rieder, 1899) the father had a rudimentary (short) fourth metacarpal bone, the ring finger being also short and small. The daughter exhibited "lobster claw" in the right hand, while

* *Edin. Med. and Surg. Journ.*, 1808, iv., 252.

the feet showed absence of certain toes, reduction of certain phalanges, and syndactyly. Such combined abnormalities in a line of descent are not infrequent. Stieve (1916) describes a case in which the thumbs of both hands have an extra joint. He cites 39 cases from the literature in which there is a supernumerary phalanx on both thumbs, and 16 in which it is on only one. In 33 cases of the former condition, occurring in 10 different families, the condition is known to be inherited, while there is no evidence of its inheritance when it occurs on only one hand.

Danforth (1919*a*) describes a condition which he calls brachydactyly in fowls. Such birds differ from the normal in that digit IV, instead of having five phalanges and being longer than digit II, varies from as long as II (not longer) to a toe having only two phalanges and no nail. He treated with alcohol (1919*b*) fowls which were heterozygous for brachydactyly, polydactyly (extra toes), and white colour—both males and females, the alcohol being inhaled for short periods. A larger percentage of brachydactylous birds was consistently obtained in the offspring of treated males, indicating that germ cells carrying brachydactyly were more resistant than normal germ cells, or possibly (though this seems unlikely) that alcohol damaged the spermatozoa so as to produce the defect. This experimental method should be applicable to a variety of cases, and furnish evidence of the relative viability of different types of germinal differences. Ultimately it might lead to a method of selectively eliminating certain undesirable types of germ cells. The studies of Pearl on the effects of alcohol on pure races of fowls, of Harrison with moths, and some other similar results, indicate that in such cases there is a selective weeding out of weaker germ cells, leaving the stronger to take part in development.

Polydactyly and syndactyly (fingers or toes united by a web of flesh) are also well known as inherited conditions. Thus Reaumur's case of a Maltese couple having a hexadactylous son, three of whose children were again hexadactylous, is referred to by Huxley (*Darwiniana*, p. 35). But usually such pedigrees are incomplete, no account being taken of the normal members of the family. Windle (1891) cites an instance from Clement Lucas, where six fingers or toes were inherited in a family through four generations. There appear to have been twenty-five normals to seventeen hexadactyls. In other records the condition has been followed for six and five generations respectively. There is some evidence that polydactyly is more common in negroes than in whites.

Lewis (1909*b*) describes Lucas's case, in which in several related families in two generations there are twenty-four normals to fifteen polydactyls. Other records cited show that the abnormality may skip a generation. There is a large degree of variation in the extent to which this dominant character is developed. Polydactylism is found not only in man, horses, fowls, and guinea-pigs, but also in monkeys, dogs, cats, and other animals. Bonavia (1895) gives several pedigrees of hexadactyly in man, with a good many cases of the inheritance of various abnormalities and sudden monstrous variations in a number of different animals.

Albert (1915) describes a family with thirteen cases of fused or webbed fingers or toes traced through four generations. The condition was obviously hereditary, but was not inherited as a regular dominant or recessive character. In three cases it appeared in children neither of whose parents were affected, when at least one of the parents had also a normal family history. Probably such irregularities in the expression of a character result from inhibition of its

development by the presence of other determiners. Many instances of the influence of hereditary determiners upon each other are now known from experimental breeding.

Schofield (1922) describes a case of webbed toes which occurs in fourteen male members of a family in four generations. The web appears only between the two toes next the great toe, and is confined to the skin and flesh. It is always more marked in the right foot than the left, and is confined to the males, being transmitted only from father to son. It thus follows the course of the Y-chromosome. The only case of this type of inheritance which has been experimentally investigated (Schmidt, 1920) occurs in the "millions" fish, *Lebistes reticulatus*, which is a native of the West Indies. A dark spot on the dorsal fin in certain males is transmitted in crosses to all the male offspring, but is not transmitted through the female line at all. Castle (1922) has also recently pointed out the significance of this type of inheritance in man.

Polydactyly and syndactyly in various forms are not infrequently found together. A case of the kind has been described in cats (Howe, 1902). A strain of polydactylous cats in Cambridge, Massachusetts, was descended from a polydactyl cat at the Harvard Astronomical Observatory. One of these cats was dissected, having six toes on each fore paw, and the toes of the hind paws fused in pairs almost to the ends of the claws.

Castle (1906) has described the origin of a polydactylous race of guinea-pigs. He says that in man "polydactyly usually makes its (recorded) appearance in some noteworthy form, is transmitted more or less strongly through two to five generations, and then disappears, doubtless so weakened by repeated outcrosses that its manifestations, if any occur,

are no longer observed." Normal guinea-pigs have four toes on each front foot, but only three on each hind foot. Castle's polydactylous race had four on all feet. The missing digits in normals are the thumb from the fore feet, and I and V from the hind feet. The polydactylous race was established from one rare individual (mutation), and was afterwards found twice in breeders' animals, but was not hitherto known in any wild or domesticated *Caviidæ*. By selection through five generations a polydactylous race was gradually established in which all the offspring were polydactylous. The inheritance is neither Mendelian nor blending, but probably intermediate between the two. Without the aid of selection, polydactylism would probably never become a racial character.

In poultry, Bateson, Davenport, and others have shown that the extra toe, which has for a long time been an established character in some breeds, is not strictly Mendelian in its inheritance, although it is more strongly established than in the four-toed race of guinea-pigs.

Radiograms of a hexadactylous Italian immigrant with six fingers and toes are given in *Journ. Heredity*, vii., 320 (1916). The condition appears to be due to a split in the rudiment of the fifth finger. A five-toed pigeon, due to a similar split in the rudiment of one toe, is also shown. A case in which the thumb is more or less completely missing from both hands is photographed in *Journ. Heredity*, vii., 224 (1916). There were various digital malformations in the relatives.

Bond (1920) crossed various five-toed and four-toed breeds of fowls. The former were the silky Dorking and Faverolle, and the latter Old English Game, Wyandotte, and Orpington. The proportions of four-toed to five-toed and heterodactylous birds

(with four toes on one foot and five on the other) varied somewhat according to whether the male or female belonged to the five-toed breed, and also in F_1 as compared with F_2 . In a total of 402 birds, 172 had four toes on both feet, and 38 were heterodactylous. Of the latter, 34 had the extra digit on the left side and only 4 on the right. In 2 birds rudiments of six toes appeared, suggesting that the character for extra toe is not stable. Bateson and Punnett also found that among 89 asymmetric birds from various matings, the extra digit was on the left side in 72 cases, and on the right in 17. In 49 other birds the extra toe was larger on one side than on the other, being larger on the left side in 34 of these cases, and smaller in 15. Barfurth, in similar matings between normal and hyperdactylous fowls, obtained 556 four-toed and 475 hyperdactylous. Of the latter, 65 were asymmetrical, 35 having the extra toe on the left and 30 on the right. In another list 12 birds were left-sided and 6 right-sided. Castle (1906) in guinea-pigs also found a slight tendency for the extra toe to appear on the left side. Out of 1,219 individuals, 630 had the extra digit on the left and 582 on the right. The explanation is not clear.

Bonnevie (1919) describes a type of postaxial polydactyly in man, which is usually stronger on the right side of the body. The extra finger arises from the base of the little finger, the metacarpal bones being normal. There is much variation in this abnormality, and families showing it are now distributed all over Norway, but they are all probably descended from the same ancestor about 300 years ago. Boas (1917) assigns two causes for polydactyly in horses: (1) Atavism, "*Hipparion*-toes"; (2) doubling of certain digital parts of the foot. The case of Cæsar's horse, which belonged to the former class, is well

known.* This condition is rare. More or less complete doubling of the extremities occurs in various mammals. Cramer (1910) discusses cases of polydactyly in man, horses, a lamb, fowls, pigs, and a calf. Fackenheim (1888) describes a family in which hereditary polydactyly is combined with tooth anomalies. The Heizler family showed polydactyly as a simple dominant in four generations. A polydactylous man of the third generation married a woman with tooth anomalies, having two abnormally large, pointed teeth in place of the incisors and only two cheek teeth. Of their six children, three were normal and three showed both abnormalities with some variations in the condition of the teeth.

A recent case of polydactylism in cattle is described (Roberts, 1921). Many instances have been recorded. In this one, from a herd of dairy cattle in Illinois, a normal bull mated with a polydactylous cow, having three toes on each foot, produced a polydactylous female. She was mated to a normal unrelated bull and produced three male calves, all polydactylous, but one with a duplication of the metatarsal bones of the hind feet, which bore four and five toes respectively. The character is evidently dominant in inheritance. The third or extra toe is on the inside, and probably represents digit II. It is always larger on the hind feet than on the fore feet.

Bateson (1894, p. 376) describes a three-toed strain of cattle from a three-toed cow bought in 1861. The strain lasted until 1887, producing about ten genera-

* The reference is in Suetonius, Bk. I., chap. lxi.: "Utebatur autem equo insigni, pedibus prope humanis et in modum digitorum unguis fissis." ("He rode a remarkable horse too, with feet that were almost human, for its hoofs were cloven in such a way as to look like toes.") The writer goes on to say that it was born in Cæsar's stables, that he tended it with great care and was the first to mount it, and that a statue of it was afterwards dedicated in front of the temple of Venus Genetrix.

tions. The condition appeared in both males and females, but the bulls were not kept, so transmission was only through the cows. About two calves in three had the extra toe. The abnormality was confined to the hind feet, except in one case. As the last members of the strain were all males the breed was lost. This instance of polydactyly is very similar to the last. The inheritance was evidently the same, but the character itself shows the interesting difference that it is less extreme. It is confined to the hind feet, except in one individual, whereas in Roberts's herd it is present on all four feet, but is larger on the hind feet. Such slight constant differences in abnormalities are of fairly frequent occurrence, and they throw an interesting sidelight on the structure of the germ plasm and the almost infinite variety of the changes which it can undergo.

A very good case of syndactyly in ungulates is that of the mule-foot hog, a type with solid instead of cloven hoofs, which has long been known in the Western States of America, and is also found in Germany and elsewhere. Detlefsen and Carmichael (1921) find that in crosses between a pure-bred mule-foot boar and pure-bred Duroc-Jersey sows the offspring, numbering about 250, were all black and mule-footed like the sire. Later generations showed that syndactyly was a simple dominant to normal, and black to red of various shades.

Bateson (p. 387) gives numerous data on the subject. He states that solid hoofs in pigs is a relatively common variation, that they are mentioned by Aristotle, and are found in various parts of the world. Sir N. Menzies at Rannock, Scotland, had a breed of such hogs for forty years. They came from a pair, and were black and of smaller size than the type, with smaller ears. Their flesh was considered more sweet and tender, and several hundred were bred at a time.

In crosses they showed alternative inheritance, but they finally became extinct. Another pair of solid-hoofed pigs was received by the Zoological Society of London from Cuba in 1876. Auld (1889) reports soliped (solid-hoofed) swine from Texas in 1878. They bred true, and when crossed with the normal gave a majority of solipeds. Another breed of solid-hoofed hogs was reported from a farm at Sioux City, Iowa, and a wild herd from near Baton Rouge, Louisiana. In another instance a Poland-China boar with *one* solid hoof had many offspring in the same condition. Probably the solid-hoofed condition has arisen many times through independent mutations.

A peculiar case is recorded by Colonel Hallam* of a race of pigs observed in a town on the coast of the Tanjore country in 1795. Drawings of two individuals were submitted. The pigs had only two legs, the hinder extremities being entirely wanting. They bred true for at least three generations. Such cases must arise through some mishap to an element of the germ plasm.

Darwin† cites the following conditions in horses as plainly hereditary: ring-bones, curbs, splints, spavins, founder and weakness of the front legs, roaring or broken and thick wind, melanosis, specific ophthalmia, blindness, crib-biting, jibbing, and ill-temper. He quotes Youatt: "There is scarcely a malady to which the horse is subject which is not hereditary."

Many records of syndactyly in man are extant, but usually the inheritance has only been traced from parent to offspring. It is recognised as a Mendelian dominant condition. Hurlin (1921) describes a case of limited syndactyly in an old New England family in which the web occurs only between the second and

* *Proc. Zool. Soc.*, 1833, Part I., p. 16.

† *Animals and Plants*, chap. xii., p. 454.

third toes, and is sometimes even there so slight as to be scarcely noticeable. It is not found in the hands at all. The condition is found in the grandfather, in his only child (a son), and in three out of six of the F_2 generation in accordance with Mendelian expectation. There is no doubt that innumerable slight abnormalities of this kind occur in man and are inherited in the Mendelian manner, as has been shown to be the case with many similar mutations in *Drosophila*.

Schultz (1922) adopts Weidenreich's term zygodactyly for true webbing, confining the term syndactyly to those cases where a union or fusion of bones is involved. Zygodactyly is found in many mammals. In a Sumatran ape *Siamanga syndactyla* (see Wallace, *Malay Archipelago*, p. 134), the two first digits of the feet are joined together nearly to the end. In an early stage of development of the human foot the toes are all webbed, and the webbing extends slightly further between the second and third toes than between any others. Webbing or zygodactyly is, therefore, a case of arrested development. It is also found that when certain toes are webbed the corresponding tendons are joined for a greater distance. Schultz cites the observations of Schurmeier, who examined 20,000 men in the American army and found 8 cases of zygodactyly, always between toes II and III. This condition was combined in some cases with webbing of fingers III and IV, or I and II and III and IV, or all fingers. In a family described by Sommer, the webbing of toes II and III was only on the right foot in all members, the pedigree extending through five generations. It was inherited by both sexes, probably as a simple dominant. In Schofield's (1922) family the webbing is always longer on the right foot and is transmitted only from male to male, appearing in all the sons

(13 cases) and none of the daughters (11 cases) and following the Y chromosome. In Hurlin's family, mentioned above, the webbing was longer on the left foot and was exhibited in both sexes. In three other families, by Pfitzner, Wolff, and Wile, the character also appears to be a simple dominant.

Sometimes syndactyly and polydactyly appear in the same family, as in the family described by Manson (1915). This family originated from one William Joseph, born in Aberystwyth about the beginning of the nineteenth century. He had webbing of the third and fourth fingers of his hands, and six toes on each foot, and was probably homozygous for this condition, since his nine children all had it. They married normals, and had a total of eighteen children affected, eighteen normal, four doubtful. In only three descendants is the abnormality complete in all four limbs. One, two, or three limbs may escape. Skiagraphs show incomplete polydactylism in some cases. There is considerable variation in the condition, but skiagraphs show clearly that the fourth digit of the hands and feet is consistently affected by complete or partial reduplication. Another polydactylous family is described by Atwood and Pond (1917).

Many data concerning hyperdactyly are given in a paper by Ballowitz (1904). Records of extra fingers and toes are known not only in "Caucasians," but also in Negroes, Arabs, Chinese, and Amerindians (North American Indians). Most frequently only an extra terminal phalanx is present, but six-fingered men have been known from the earliest times. In the Bible (2 Sam. xxi. 20) a "giant" is mentioned who had six fingers on each hand and six toes on each foot. He was one of four men of exceptional stature—sons of a giant. Pliny referred to hexadactylous persons as *Sedigiti*. Anne Boleyn, the

beautiful wife of Henry VIII., is said to have had supernumerary breasts,* teeth anomalies, and an extra terminal phalanx on hands and feet.† The "outside" digits—*i.e.*, thumb and little finger and great and little toe—most commonly show doubling. Doubling of other digits is much more uncommon, becoming still more so as the number increases. Thus the presence of ten digits on one hand or foot is extremely uncommon in museums, while cases of seven are relatively often described. This condition is often combined with other abnormalities, but hexadactyly and heptadactyly often occur in otherwise normal individuals. The extra digits are frequently syndactylous, not fully separated from their neighbours. Hexadactyly is often symmetrical (two double thumbs or two double little fingers), but there are many exceptions, and scarcely two cases agree in detail.

Three main types of abnormality appear: (1) Simplest and most common; the extra digit is a small attachment not adherent to the skeleton, and often without bones or cartilage, muscle or tendons. (2) Often the extra digit is more or less like an ordinary finger or toe, containing bones and connected with the skeleton of the finger. (3) Very seldom the extra digit is complete and also has its

* Other cases of supernumerary mammæ in more than one generation are cited, for example, by Darwin, *Descent of Man*, p. 41.

† The only confirmation of this statement I have been able to find is the following, from Wyatt's *Life of Anne Boleyn* (Ed. Singer, p. 423): "There was found, indeed, upon the side of her nail upon one of her fingers some little show of a nail, which yet was so small, by the report of those that have seen her, as the workmaster seemed to leave it an occasion of greater grace to her hand, which, with the tip of one of her other fingers, might be, and usually was, by her hidden, without any least blemish to it." It is a fact, however, that among the portraits of the wives of Henry VIII., Anne Boleyn's is the only one in which the hands are not shown.

own metacarpal or metatarsal bone. All possible intergrades are said to occur between these forms.

Russian statistics are quoted of fourteen families in which the extra finger is inherited, also ten families with six fingers and six toes, while Hennig in 1880 recorded polydactyly in seventy-seven families. The condition may extend through two to five or many generations, and ten to forty hyperdactylous individuals have been recorded in many families. Polydactylous twins are twice recorded, and one polydactylous twin sister had four normal sisters. Reaumur's Maltese family is also quoted in detail by Ballowitz. In two generations descended from Gratio Kaleïa, who had six fingers on each hand and six toes on each foot, and his normal wife, there were ten hexadactyls and six normals, but in the former the abnormality did not always appear on all four limbs. In the pedigree of Elizabeth Horstmann of Rostock (Mecklenburg), who had six digits on all four limbs, her daughter was like the mother, and the next two generations from marriages with normals gave seven hexadactyl to seven normal, in conformity with expectation for a simple Mendelian dominant. In another pedigree, Marie Schweizer of Fischbach, three generations of descendants include eight hexadactyl and ten normal. In yet another hexadactylous pedigree (Alexander) there were in three generations of descendants nine hexadactyls to ten normals. All hexadactylous individuals in this pedigree showed a striking symmetry, and in one male the condition was combined with syndactyly. In another pedigree, quoted from Marchand, in which the condition ran through five generations, a family of eight in the fourth generation all had six fingers and six toes. The father, who was hexadactylous, must have been homozygous for the trait. The family of the Sultan of Pontianak (Borneo) is hexadactylous, and

this condition is recognised in each generation as a mark of royal distinction! Ballowitz quotes from the French literature (1863) the case of an isolated village in the Département d'Isère, in which, through inbreeding, nearly all the inhabitants had six fingers and toes. Later, owing to increased communications, marriages with normals took place, and the extra fingers and toes in newborn children became smaller and fewer, finally disappearing altogether. This is a good example of the "weakening" and disappearance of an abnormality through exogamy, but brachydactyly does not appear to be affected in this way.

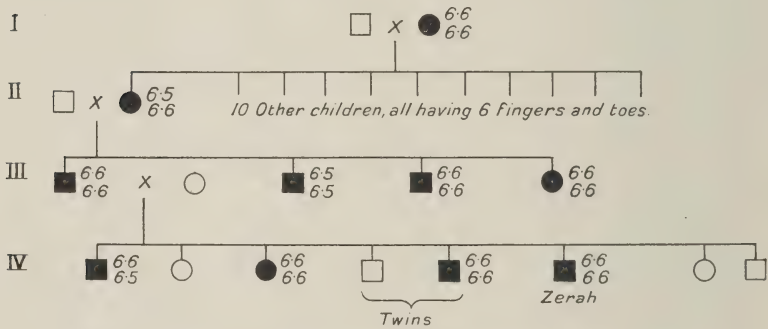

FIG. 18.—PEDIGREE OF HEXADACTYLY.

If such weakening of a character like hexadactyly can take place through exogamy, it is an important hereditary principle which requires further elucidation, especially in comparison with conditions like brachydactyly where no weakening effect is observed even after many generations of outcrossing.

An interesting hexadactylous family is described by Carlisle (1814). Zerah Colburn, the son of Abiah Colburn, born in Vermont, was brought to London on account of his "extraordinary powers in arithmetical computations from memory." He had a supernumerary little finger on each hand, and an

extra little toe on each foot. The extra digits were all perfectly formed, with nails and three phalanges. The father also was hexadactylous, having five metacarpal bones, but six metatarsals. The pedigree of this family through four generations is given in Fig. 18. Beside each is given (above) the number of fingers and (below) the number of toes. The inheritance is strictly that of a Mendelian dominant, with occasional failure of one hand or foot to exhibit the abnormality.

In another hexadactylous family (Sedgwick, 1863, p. 188) an extra finger with two phalanges and a nail

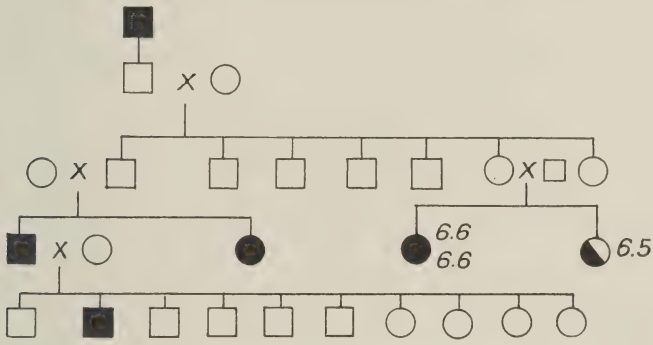

FIG. 19.—HEXADACTYLOUS FAMILY.

was attached to the base of the first phalanx of each little finger. The condition was followed through four generations. There was some variation in its expression, and it skipped two generations both in the male and the female line (see Fig. 19).

Schroeder (1918) described a condition of hypodactyly appearing in the hands and feet of a family for five generations and accompanied by other deformities. The strain originated with a woman, who is said to have had normal parents. She produced three affected and two normal children, the latter having only normal descendants, while the

former had twenty-eight normals to sixteen affected offspring. The condition is transmitted by both sexes, and shows a tendency to become less marked in later generations.

Hawkes (1914) has compared different types of human foot as regards the relative lengths of the first and second digits. From an examination of the feet of 2,300 persons, chiefly children, he finds the "L" type of foot, with the great toe longest and the other toes sloping back in an oblique line, the commonest. The "S" type, in which the second toe is longer than the great toe, is much less common. Not very rarely one foot will be of the L type, and one of the S type. This is in heterozygotes, but some persons with both feet L are heterozygous. The "E" type, in which digits I and II are of equal length, is very unusual. The L type of foot shows irregular dominance over the S type in inheritance, but the S type occurs more commonly in females than in males, and is commonest in the fœtal stage. The male heterozygote tends to be L, and the female to be S, in foot pattern. Occasionally digit III is longer than digit II, and this condition is also found to be hereditary.

VARIOUS ABNORMALITIES.

Lundborg (1920) concludes that hereditary deaf-mutism is due to one Mendelian recessive factor, and rejects Plate's hypothesis of two factors. Acquired deaf-mutism may be either intra- or extra-uterine in origin. Hence congenital deafness is not always hereditary. Irish statistics of the year 1891 register congenital deaf-mutism as 76 per cent. of all cases. In Norway (1897) the number was estimated at 50.9 per cent., in Sweden (1904) at 40.8 per cent., and in the Malmöhus district of Sweden (1919) at only 28.2 per cent. (108 in 383). Meningitis and scarlatina

are said to be the most common causes of acquired deaf-mutism. In addition to the difficulty in distinguishing between genotypical (inherited) and phenotypical (acquired) deaf-mutism a statistical error is introduced by the fact that in small families the children may all be normals, even when the parents are heterozygous for the condition. Since these children are not added to the offspring of matings of heterozygotes, the result is more than 25 per cent. of abnormals. This can be corrected by applying a formula of Weinberg, and it then closely approximates to the expected 25 per cent.

From Fay's evidence of marriages of the deaf in America (1898), twenty-two families had four to nine children each, all deaf. The children numbered 112. Hence it appears that genotypical deaf-mutes will have only deaf-mute children, and from this and other evidence it appears that the character is probably a simple recessive. The difficulty in all statistics on this subject is to distinguish between genotypic and phenotypic deaf-mutism. Love (1920) also reaches the conclusion that sporadic congenital deafness is inherited as a Mendelian recessive, from a study of an Ayrshire family which has branches in America and Australia. This family shows five affected generations descended from a common ancestor three generations further back. Yearsley (1920) gives an account of a family with a history of "acquired" deafness, which produced offspring born deaf. But as the acquired deafness is apparently hereditary otosclerosis, this is merely a case of the earlier appearance of the abnormality. Horne (1909), in a study of deaf-mutism, says that the number of deaf-mutes in Europe is estimated at about 1 in 1,350 of the population. In England the frequency (from statistics) is 1 in 2,043, Scotland 1 in 1,860, Ireland 1 in 1,398. Seven pedigrees are recorded, but

there is no separation of hereditary and acquired cases.

Myoclonus - epilepsy, marked by (degenerative) spasms of various muscles, is also a disease transmitted as a homogeneous recessive character. One of the most complete of family studies is that of Lundborg (1913) on a farmer family in Southern Sweden having this affliction. Among the 2,232 individuals examined he groups (1) 11 families as $DD \times RR$, with 166 children all normal; (2) 11 families $DR \times DR$, with 93 children, of which 77 reached an age of over 15 years. Of these, 24, or 31.2 per cent., were abnormal. Applying the statistical correction of Weinberg gives 21.8 per cent. abnormal where the expectation is 25 per cent. (3) $DR \times RR$, 5 families with 46 children, of which 40 reached over 15 years of age. Twenty of these were normal, or 45.3 per cent. with the statistical correction. This is the only Swedish family known to have the peculiarity, and the results are in very good agreement with Mendelian expectation.

A condition which is said to be rare is hereditary tremor. Bergman (1920) states that fifty families showing this condition are mentioned in the literature. It consists in rapid involuntary and rhythmic contractions of certain groups of muscles. Usually the arms and hands are affected, but sometimes also the head or legs or the whole body. Hereditary tremor most frequently appears in early youth, and often increases in intensity later. It generally ceases during sleep and perfect rest. Sometimes it appears only in connection with exertions or emotions. The tremor may be rapid (8 to 10 vibrations per second), or slower (3 to 4 per second). People with hereditary tremor are often nervous and emotionally unstable. The handwriting is affected, and may be almost or quite illegible. Bergman traces this condition

through three generations (four individuals) in a Swedish peasant family. The condition is probably similar to paralysis agitans, which is said to be due to the degeneration of the parathyroid gland.

Ataxia in pigeons is apparently a very similar condition. In 1914 Riddle (1918) obtained in breeding experiments a female pigeon with marked lack of control over the voluntary movements of head and body. It appeared, probably as a mutation, under conditions of "reproductive overwork," in which the bird is obliged to continue laying by removing the eggs; and the condition has been inherited through five generations. About 175 young have been reared, and of this number 119 were classified as normal and 46 as affected. From these and other matings the evidence indicates that ataxia is inherited as a simple recessive with some irregularities. Affected birds show quivering movements, nodding heads, unsteady gait, and irregular flight in various degrees. Koch and Riddle (1918) analysed the brains of ataxic birds in comparison with the normal. They found in the former higher values for water content, protein, and extractive sulphur, with lower values for lipoids, phosphatids, and cholesterol. The results suggest a chemical immaturity or underdevelopment of the affected brain, more like those of normals at a younger stage of development, but further investigations of this subject are desirable.

In the mountains of Georgia a family is found (Stuckey, 1916) some of whose members for four generations have had constricted eyelids. The sight is normal, yet owing to this constriction it is necessary for them to avert their heads in order to see. The manner of inheritance indicates a segregating dominant character.

Another peculiar case, of hereditary nose bleed, is recorded (Lane, 1916), members of a family in

Maine showing the trait through three generations. It is not, like hæmophilia, sex-linked. It manifests itself by spontaneous bleeding at the nose almost daily, beginning at the period of adolescence and continuing until eighteen or twenty. Individuals showing it are vigorous in health and grow rapidly, often feeling discomfort if the bleeding does not take place.

Diseases like hæmophilia (abnormal tendency to bleeding), Gower's disease (saltatory spasms), and colour-blindness are well known to be sex-linked in their inheritance, but with complications in the last instance. Bulloch and Fildes (1910) bring together a vast amount of information concerning hæmophilia, with many pedigrees. Nasse in 1820 asserted that it is transmitted entirely by unaffected females to their sons. Of the 171 recorded instances of transmission, belonging to forty-four families, sixty conform to the "law of Nasse." In the eleven other families, in some of which inheritance from father to son was supposed to have taken place, there is no good evidence that this ever took place. Such apparent cases are found to be explained by intermarriage of "bleeder" families or in other ways. In the forty-four families studied there were 644 males to 464 females—a great excess of males. The marriage-rate of males in bleeder families is very much lower than of females (9.6 per cent. : 36.8 per cent.). The disease is rare. Lenz (1912) gives an extensive bibliography of hæmophilia.

Among recessive conditions are alkaptonuria* and albinism. The most extensive pedigrees of cataract have been those collected by Nettleship (*cf.* Bateson, 1909). They show that various forms of cataract are usually transmitted as dominants. Harman (1910) classifies cataracts as lamellar, axial, stellate,

* A condition in which alkapton (probably a derivative of tyrosin) is present in the urine.

and polar. Details are given of a number of pedigrees of inheritance, but no attempt is made to draw conclusions regarding the manner of inheritance. In another paper, however, the same author (Harman, 1909) cites a pedigree of five generations showing the condition to be a Mendelian dominant. Parents who are normal have only normal children. Of fifty-five persons, nineteen were known to be affected. Others who were not examined probably had the defect slightly. Among forty-one persons personally examined or certified, nineteen were cataractous. This is very close to the expected 50 per cent.

The indications of the *de novo* origin of hereditary congenital cataract are clearly substantiated by the pedigree of a family whose history is described by Danforth (1914). That congenital cataract is a dominant character has been disputed by Jones and Mason (1916*a*), who, from a discussion of Harman's data in the *Treasury of Human Inheritance*, conclude that it is a simple Mendelian recessive. This conclusion was criticised by Danforth (1916), who, however, did not hold that a single Mendelian factor was involved. In their reply Jones and Mason (1916*b*) conclude that it is impossible to arrive at a satisfactory view of cataract inheritance, but that the hypothesis of a single Mendelian recessive is the one that is best supported by the facts in hand. Detlefsen and Yapp (1920) describe a case of congenital cataract in cattle, which they conclude behaves as a simple Mendelian recessive. A registered Holstein-Friesian bull inbred with his own stock gave a number of cataractous offspring. There is no record of cataract in any of the ascendants. To unrelated cows this bull produced only normal calves. But thirty-two F_1 daughters mated to an F_1 son gave sixty-three calves, fifty-five of which were normal and eight had congenital cataract of the stellate type.

An early record of sex-linked colour-blindness ("Daltonism") is of such interest that it is included here. It was communicated to the Royal Society in 1778 by the Rev. Michael Lort, and consists of a letter from Mr. J. Scott to the Rev. Mr. Whisson of Trinity College, Cambridge, describing his infirmity, and stating which of his relatives also possessed it. This has been thrown into the form of a pedigree chart by Cole (1919), from whom Fig. 20 is taken with modifications. No. III. 3 is the deponent, and it

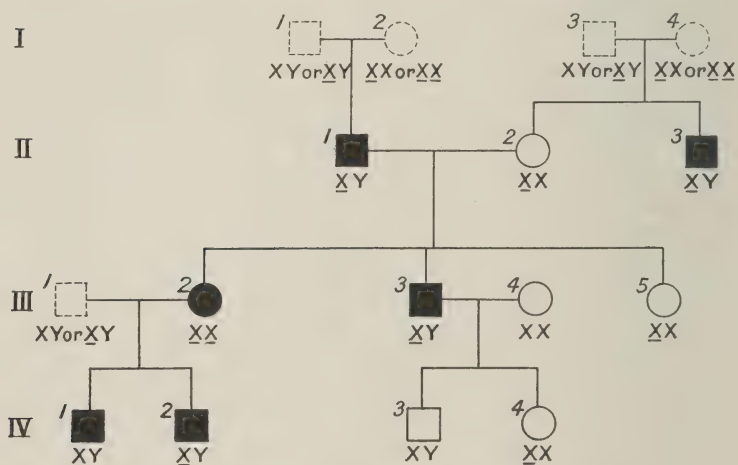

FIG. 20.—PEDIGREE CHART OF COLOUR-BLINDNESS.

will be seen that his father and his mother's brother were also colour-blind. His mother, though normal, had a colour-blind son and daughter, and she must therefore have been heterozygous for the character (see Fig. 8, p. 23), which gives the history of the sex chromosomes. Homozygous colour-blind mothers transmit the defect to all their sons, as in generation IV., while normal but heterozygous mothers transmit it to half their sons.

Fathers, on the other hand, never transmit the

defect to their sons; but half their daughters by normal mothers will, though normal, be transmitters to half *their* sons by a normal father. Heterozygous mothers with a colour-blind father will have 50 per cent. of colour-blind daughters (while all the daughters will transmit the defect), and half the sons of such a marriage will also be colour-blind. Regarding the deponent's grandparents there is no record, but the grandmothers must both have been either colour-blind or heterozygous transmitters of the defect, while the grandfathers may or may not have been colour-blind.

A shorter account of another case of colour-blindness is given in a letter written in the previous year by Mr. Joseph Huddart to the Rev. Joseph Priestley, and published in the *Phil. Trans.*, 1777. A shoemaker named Harris from Maryport, Cumberland, was colour-blind, having discovered it at the age of four years through being unable to distinguish a red stocking from an ordinary (presumably black) one. He also observed that "when young, other children could discern cherries on a tree by some pretended difference of colour, though he could only distinguish them from the leaves by their difference of size and shape." Colour-blindness consists essentially in the failure to distinguish red from green. This man "had two brothers in the same circumstances as to sight; and two other brothers and sisters who, as well as their parents, had nothing of this defect." Evidently the mother was heterozygous, and transmitted the defect to half her sons. According to Bateson (1909), in European countries at least 4 per cent. of the male population and less than 0.5 per cent. of the females are colour-blind.

Bowditch (1922) describes three families related through marriage, all showing the usual type of sex-linked inheritance. In one of the families the

condition is present in the males of three generations, being transmitted in one case through two generations of females before reappearing in a male. In the second family there were two cases of colour-blind females, one of whom had three sons, two of whom were known to be colour-blind.

Little and Gibbons (1921) have recently considered the inheritance of hæmophilia and colour-blindness in relation to the presence of sex-linked lethal factors, which would, of course, follow the same line of inheritance. If there is linkage between a sex-linked lethal factor and the normal allelomorph to hæmophilia or colour-blindness (the latter being due to different defects in one X chromosome, and the normal to a non-defective X chromosome), then the authors show that there should be an excess of abnormals among the males in pedigrees in which these sex-linked diseases occur, and a decreased proportion of females in families in which an excess of affected males does not occur. From the data of Bulloch and Fildes (1910), as well as other data at the Eugenics Record Office, they find these expectations fulfilled, thus furnishing evidence of sex-linked lethal factors in man.*

Congenital stationary night-blindness was recognised as a Mendelian dominant by Nettleship (1907). It was in existence near Montpellier as early as 1637. Data were afterwards obtained from the parish records, and in 1836 Cuvier published a pedigree of seven generations. The Abbé Capion completed

* Lethal factors have been most extensively studied in *Drosophila*. Their presence causes the normal development to go astray, leading to the death of the organism at an early or a later stage in its development. Enriques (1919) has shown that in the fly *Calliphora erythrocephala*, certain individuals produce 25 per cent. of non-vital offspring. The larvæ cease to eat after two or three days and then die. Some of the non-lethal offspring in turn produce lethals in varying proportions.

these records and added later ones, making ten generations. The night-blindness was first brought to the village by Jean Nougaret, who was born about 1637. It has therefore been handed down for about 250 years through a large number of individuals. Bateson (1909, p. 220) gives a chart of this pedigree.

In another family studied by Newman (1913), night-blindness (hemeralopia) is inherited like colour-blindness, as a sex-linked character, being transmitted through unaffected daughters of affected males to some of their sons. This family is from Texas, having originated in North Carolina. In one respect it departs from the typical scheme for sex-linked inheritance, in that there is "apparent non-inheritance of the capacity to transmit night-blindness on the part of the sisters of night-blind men." In F_3 and F_5 , if there were no consanguineous marriages, there should be equal numbers of females carrying or not carrying night-blindness. But none of the five married sisters of F_3 night-blind men show any trace of night-blindness in their progeny. Newman suggests that possibly night-blindness cannot be inherited through two successive generations in the female line, owing to prolonged association of the defective X (sex) chromosome with a normal X. The next generation will determine whether this is the true explanation.

In its main essentials the character in this family behaves as a recessive located in the X chromosome, but, as in hæmophilia, there is an excess of abnormals. Thus, of the 36 offspring of the night-blind-carrying daughters of night-blind men, there were 22 ♂, 14 ♀, and of these 22, 17 were affected and only 5 not. In this family the night-blindness is usually accompanied by myopia (short-sightedness), and almost invariably by strabismus (squinting), with frequent occur-

rence also of pterygium.* It is believed that all these conditions form one complex, and whether all appear may depend on other factors present.

Nettleship (1912) has also described a family in which night-blindness was sex-linked and was associated with myopia. It would, therefore, appear that the same condition may arise through an alteration in the sex chromosome or in another chromosome.

The inheritance of many other abnormalities of the eye is known. For example, Folkar (1909) has traced nodular opacity of the cornea through three generations, finding nine cases abnormal to nineteen normal or unknown.

A bibliography of hereditary eye defects has recently been published by Howe (1921). Among hereditary defects are included corneal degeneration, coloboma (congenital fissure) of the iris, aniridia (absence of iris), glaucoma (a disease of the eye with intense intra-ocular pressure, resulting in hardness of the eye and blindness), cataract, congenital dislocation of the lens, retinitis pigmentosa (inflammation of the retina, with sclerosis, pigmentation, and atrophy of the retina), atrophy of the optic nerve, microphthalmus (abnormally small eyes), myopia (short-sightedness), astigmatism (a defect in the lens of the eye, in which not all light rays are brought to a focus at the same point), nystagmus (continuous rolling movement of the eyeball), and ptosis (drooping of the eyelid owing to paralysis).

Briggs (1918) has studied the inheritance of ptosis (paralytic drooping of the eyelid) through six generations from a woman having this ocular defect. The lineage belongs to a family in the mountains of the Southern States, and included 128 individuals, half

* Congenital pterygium or epitarsus is an abnormality of the eye in which there is a fold in the conjunctiva or membrane lining the eyelid and covering the front of the eyeball.

of whom had the defect. Photographs are given, and a chart indicating that the character is a Mendelian dominant.

Nyctalopia or day-blindness is also said to be hereditary. Sedgwick (1861) cites a case of momentary blindness after bending their heads in a father and two sons. He also refers to the Le Compte

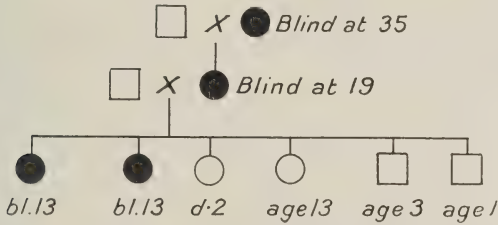

FIG. 21.—FEMALE SEX-LINKED BLINDNESS.

family, in which thirty-seven children and grandchildren became blind, like the grandfather, at the age of seventeen or eighteen years.

Two interesting, because contrasted, pedigrees of amaurosis or hereditary blindness are given by Sedgwick (1863). In the first (Fig. 21) the condition

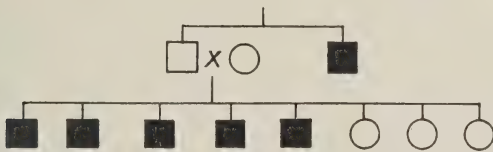

FIG. 22.—MALE SEX-LINKED BLINDNESS.

is apparently confined to the females, who go blind before middle age. In the second the same condition is confined to the males and skips a generation in inheritance (Fig. 22).

Several pedigrees of sex-linked inheritance of exceptional interest are described or cited by Sedgwick (1861). One of them is a family with ichthyosis

(see also p. 122), which is evidently transmitted by females to half their sons, as indicated in Fig. 23, compiled from the data given.

In another family, cited from Cunier, thirteen cases of ichthyosis occurred in five generations, and all the affected individuals were females. Hence the

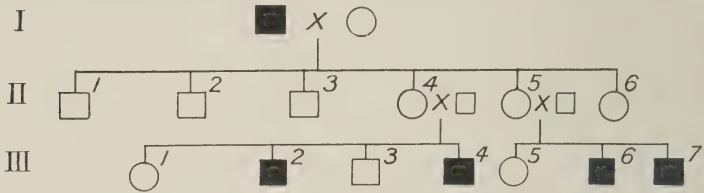

FIG. 23.—PEDIGREE OF MALE SEX-LINKED ICHTHYOSIS.

condition is in this family female sex-linked. The character must, therefore, behave as a dominant in the females of the latter family and as a recessive in the females of the former family.

An even more remarkable case of female sex-linked inheritance is described by Cunier (1839), in which

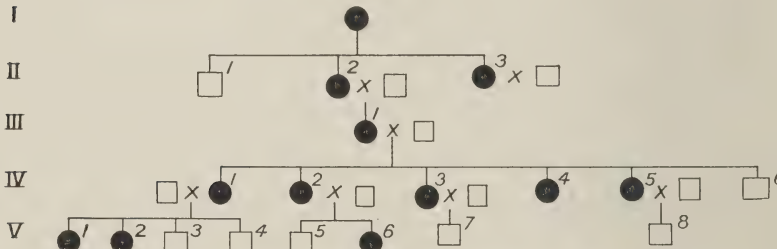

FIG. 24.—PEDIGREE OF FEMALE SEX-LINKED COLOUR-BLINDNESS.

colour-blindness is inherited from mother to daughter alone through five generations (see Fig. 24) in a Belgian family. This again appears to be because the character is behaving as a dominant instead of a recessive.

The condition is transmitted from mother to

daughter directly in the female line—that is, it is sex-linked or, better, female sex-linked. It may be spoken of as matrilineal in descent. The appearance of the character in heterozygous females shows it to be a dominant. We may think of such females as having one affected and one normal X chromosome (see p. 23). This would be transmitted to half the sons, none of whom are affected, presumably because the presence of the Y chromosome in some way neutralises its activity.* Half the sons should then be capable of transmitting colour-blindness to all their daughters. Unfortunately the records of the family furnish no data regarding the male lines of descent in this family. But it seems likely that if such transmission had occurred it would have been noticed, because the facts are evidently carefully recorded. It is possible, therefore, that transmission through the males may fail, just as it appears to fail to be inherited through two successive generations in the female line in the night-blind family studied by Newman (1913) (see p. 115). Another possible explanation would be that only sons who have received a normal X chromosome are viable. This should lead to a deficiency of males in the offspring. It is very interesting to find colour-blindness transmitted as a sex-linked dominant in this family and a sex-linked recessive in others. In this Belgian family Madame Th—— (III. 1, Fig. 24) and her aunt and grandmother could not distinguish blue from red (“rouge”), while her descendants confounded blue with “cerise.” The eyes of affected individuals were very sensitive to light.

Sedgwick (1861) states that inability to distinguish colours is often associated with inability to distinguish

* There is some evidence (see p. 94) that in man and in fishes, unlike insects, the Y chromosome plays an active rôle in inheritance.

sounds, and cites a family in which all the colour-blind members were also stone-deaf. He also describes an interesting family, here thrown into pedigree form (Fig. 25), having coloboma iridis or cleft iris. This pedigree is difficult to explain, for it not only shows transmission, as in an ordinary male sex-linked character, through an unaffected mother to half her sons, but also direct transmission from father to son in two cases, unless the wives here happened to be transmitters. One son (III. 7) only had the defect in one eye. Sedgwick also describes cases of inheritance of aniridia (absence of iris), amaurosis (blindness), microphthalmia, absence of eyes, and squinting. The latter is due to defective musculature of the

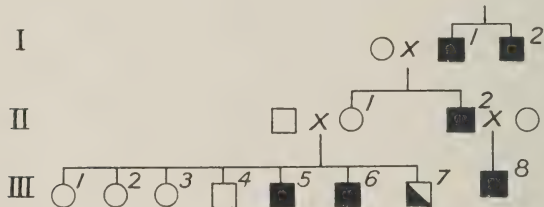

FIG. 25.—FAMILY SHOWING CLEFT IRIS.

eye, and is stated to be hereditary in some families for many generations. In one family the five boys squinted in the left eye or in both eyes, while the five girls were normal. Their father and mother were normal, but the mother's sister had a boy and girl both squinting with the left eye.

A celebrated case which is often referred to in the early literature is that of "the porcupine man," Edward Lambert. The first account appears to be that of Machin (1733). A country labourer showed his son, who was then fourteen, in London. The son had a very scaly skin which did not bleed when cut, but was callous and insensible. The skin was shed every year in the autumn, a new skin growing up

underneath. It had "bristly parts" about the belly and flanks, which rustled like the quills of a hedgehog. He was born normal, but the skin began to turn yellow at the age of seven or eight weeks, then by degrees changed to black, then thickened and grew into its present condition. The parents were apparently normal and had "many other children," none of which showed this deformity, which seems to have been an extreme form of keratosis.

Further details of this individual are given (Baker, 1755) when he was about forty years old. The skin most nearly resembled "an innumerable company of warts," of a dark brown colour, and near an inch in height when fully developed. His head and face, palms and soles, alone were free from this condition. He now had six children, all with the "same rugged covering as himself," the condition making its first appearance about nine weeks after birth. The describer draws some interesting conclusions, which we may quote in his own words: "It appears, therefore, past all doubt, that a race of people may be propagated by this man, having such rugged coats or coverings as himself; and if this should ever happen, and the accidental origin be forgotten, 'tis not improbable they might be deemed a different species of mankind: a consideration which would almost lead one to imagine that if mankind were all produced from one and the same stock, the black skins of the negroes, and many other differences of the kind, might possibly have been originally owing to some such accidental cause." In modern language we should call this individual a simple dominant mutation, like so many of the other abnormalities in man.

According to Sedgwick (1861), this condition was perpetuated for two more generations, two brothers of the fourth generation visiting Germany in 1802.

They had seven sisters who were normal, from which it would appear that the character was male sex-linked—in other words, recessive or suppressed in the presence of the normal X chromosome in females, and dominant or finding expression in the presence of the Y chromosome in males.

A less extreme form of the same condition (Martin, 1818) was Jane Holden, aged three, whose whole skin except the face was “covered with small scales, or rather warty or bristle-like projections,” light brown to black in colour and constantly exfoliated. The condition began at the age of three months. Her mother was the same, except that the neck, breast, and forearms, as well as the soles of the feet, were free from this condition. Her parents were healthy, and she was the only one of six children having the disease. In this family, unlike the previous ones, the condition is therefore not male sex-linked.

Still less severe forms of ichthyosis were formerly said to be rather frequent on the Continent, and were called “pellagra.” Sedgwick (1861) quotes Italian statistics among the peasants of Lombardy, in which, in 184 families, there were 671 healthy individuals and 648 showing pellagra. From this it would appear that the condition perhaps involved a simple Mendelian recessive character. In modern studies of pellagra (see Davenport, 1916) in Italy, the United States, and elsewhere the essential symptoms appear to be inflammation and ulcerations of certain areas (often symmetrically placed) of the skin, often accompanied by diarrhoea from ulcerations of the intestine. These symptoms are due to the presence of a toxic agent, which may also induce nervous and mental disturbances in some individuals. Variations in these symptoms are partly due to differences in the hereditary constitution of affected individuals, leading to differences in the susceptibility or resistance of

various organs to the toxin. Davenport considers that pellagra is probably communicable, but the history of the disease will depend entirely upon the constitutional conditions of resistance which it meets in the organs of the body. When both parents are susceptible to the disease, nearly half the children are susceptible, while the disease affects less than 1 per cent. of the whole population (statistics from Spartanburg Co., South Carolina). The high incidence in certain strains will, then, be due partly to infection, but also depends upon susceptibility, for susceptible and non-susceptible children often occur in the same family. Pellagra thus bears certain resemblances, from an inheritance point of view, both to tuberculosis and cancer, and perhaps also to leprosy.

It was formerly widely held (Sedgwick, 1863) that leprosy was hereditary, but that it descends by collateral lines, and frequently skips a generation. There is probably some basis for this view, which deserves careful attention from modern students of this disease. The lepra bacillus is known, just as is the tubercle bacillus, but there may be constitutional differences in the resistance to its attacks.

Several other pedigrees showing sex-limited inheritance may be cited from a large mass of data furnished by Sedgwick (1863). Pityriasis versicolor, a skin disease, is confined to the males, but transmitted by the females to their children in a family where the grandfather, his three sons, and nine males of the next generation all have it. In another family numerous warts on the hands characterise the female line for two generations, the mother and her three daughters having them, the two sons normal.

In another family numerous sebaceous tumours on the scalp occurred in a mother, her daughter, and granddaughter, while the sons were free. The brother's daughters, however, have them, "as well

as several cousins of different degrees of relationship." Hence the condition can be transmitted through (unaffected) males. This woman's mother, grandmother, and female relations backwards for seven generations were similarly affected. "No female who had attained her tenth year of age was without them, whilst none of the males in the family ever had them." In another family exactly the same manner of inheritance occurred, a woman, the mother, mother's mother, and so on, for two more generations, all having scalp tumours, as well as several female first and second cousins on the mother's side. Again

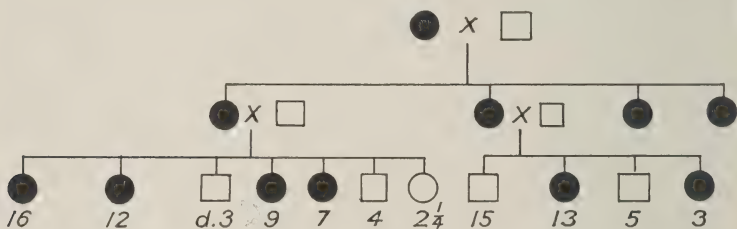

FIG. 26.—FAMILY SHOWING EARLY DECAY OF TEETH.

The numbers beneath are the respective ages of the children.

all the females and none of the males developed the condition.

A striking case of abnormal early decay and loss of the teeth in three generations of a family is given by Sedgwick (1863). It is confined to the females (see Fig. 26), and there is no evidence as to whether it is transmitted by the males.

Among family peculiarities which are known to be inherited, one of the most notable is the large lower lip and prognathous jaw of the Hapsburgs. Bateson (1909) first suggested that this peculiarity was a Mendelian dominant, and Haecker (1911), from a study of numerous portraits, confirms this conclusion. The peculiarity dates back at least to Duke Ernst the

Iron, who died in 1424, and it has been handed down continuously to the present time, hence for a period of probably more than 500 years, or fifteen to twenty generations. The condition is less marked in the women, and Haecker interprets it as the result of the loss of an inhibiting factor which normally regulates in Europeans the development of the lower lip and jaw. At least one other sporadic case of prognathism is known to me, but I am not aware of any other data concerning its inheritance. In this case the father has the peculiarity, while one of four children has it in an extreme degree and two others to a less degree. This type of prognathism suggests a mild form of the condition seen in the bull-dog—a mutation which also occurs in cattle, foxes, and other mammals. Dönitz (1868), for example, describes a fox skull shaped like a bull-dog's, with a short snout and the mandible turned up in front of the premaxillæ. See also Kühn (1877) and Mivart (1890), where much other information concerning variations in dogs and other Canidæ will be found.

Variations of the type just mentioned we now call parallel mutations (see Gates, 1921, chap. v.), since they result from similar changes in the germ plasm. The list of such cases in mammals, given in Table IV., is taken chiefly from Davenport (1916), who further points out that rabbits and guinea-pigs both show agouti, yellow, chocolate, black, albino, and other colours. Also the Angora type of coat is found in rabbits, guinea-pigs, cats, dogs, goats, sheep (Lincoln), and others.

The medical and anatomical literature on the subject of the inheritance of abnormalities in man is much too extensive to consider here. Only a few cases, where the manner of inheritance through several generations is known, are included. But in a great number of other pathological and anatomical con-

ditions, no doubt, further research would disclose equally extensive pedigrees of inheritance. Hope and French (1908) describe a family in which persistent hereditary œdema (swelling due to the effusion of watery liquid into the connective tissue) is traced

TABLE IV.
COMPARATIVE TABLE OF SALTATIONS.

	I	2	3	4	5	6	7	8	9	10	11
	Man.	Horses.	Cattle.	Sheep.	Deer.	Pigs.	Dogs.	Cats.	Rabbits.	Guinea-Pigs.	Mice.
1. Proöpic brachycephaly, abbreviation of face	× *		×				×				
2. Sudden development of "horns" on hornless races		×									
3. Absence of horns on horned races			×	×	×						
4. Jaw appendages	×			×	×						
5. Taillessness, absence of caudals	×	×		×			×	×		×	
6. Short-leggedness, or limb abbreviation	×	×	†	×			×				
7. Consolidation of paired hoofs, syndactylism	×		×			×					
8. Polydactylism	×	×	×	×	×	×	×	×		×	
9. Epidermal thickenings	×		×								×
10. Mottled skin markings	×	×	×			×					
11. Excessive hairiness or long hair	×	×	×	×			×	×	×	×	
12. Hairlessness, entire absence of hair	×	×	×				×				×
13. Excessively fine or silky hair	×		×	×				×	×		×
14. Reversed hairs	×		×							×	
15. Curled hair	×	×		×			×				

* See p. 215.

† Chinese polo ponies.

through five generations, appearing in thirteen out of forty-two individuals. This was accompanied by nervous attacks in many cases. The inheritance, as shown by the pedigree, is in accord with that of a Mendelian dominant, except that one normal female

has an abnormal child in a family of six. The swelling of the legs, which was extreme in certain cases, was usually kept down by wearing bandages. Several individuals lived to over seventy with their legs bandaged, having had the malady for sixty years or more. This condition was first described by Milroy in America, where it was traced through six generations, and similar cases of hereditary œdema have been described in France and England. Bulloch (1909) gives nine pedigrees of trophœdema (with permanent swelling of feet and legs), and finds it rather more common in females than in males. In a total of seventy-three affected individuals observed, forty-one were of the former sex and thirty-two of the latter. Bulloch (1909) also describes angioneurotic œdema,* or acute circumscribed œdema, in which there are local swellings of the limbs, trunk, and face, and the mucous membranes may also be involved. The swellings are temporary, but often show remarkable periodicity. There is direct inheritance in a number of instances, or the disease may occur as a family complaint.

Gossage (1908) cites many instances of inherited abnormalities. Ichthyosis (a dry, rough, and scaly skin), or keratosis (horny growths forming warts or callosities) of the palms or soles is a Mendelian dominant, and has apparently originated *de novo* in two cases, one such woman having twelve children, all, like herself, abnormal. Multiple hereditary telangiectasis (dilatation of the capillaries and minute arteries) is apparently a dominant, but appears late: fourteen abnormal to twenty-seven normals were recorded. Other cases given are inheritance of (1) tightly curled woolly hair; (2) epidermolysis

* This is a condition in which there is swelling in patches by the accumulation of blood in the connective tissue owing to a disorder of the vasomotor system affecting the bloodvessels.

bullosa (a loosened state of the epidermis, with formation of deep-seated bullæ or blisters); (3) bullosa; (4) early baldness with monilithrix (hairs brittle and with bead-like enlargements); (5) hypotrichosis congenita familiaris (children born without hair, or losing it a few months after birth); (6) enlarged spleen; (7) polyuria or polydipsia (excessive secretion of urine containing increased amounts of solid constituents); (8) prokeratosis (a skin disease characterised by hypertrophy of the corneous layer followed by inward atrophy), etc. ✓

Polyuria or diabetes insipidus is a condition in which the kidneys fail to function properly, so that the individual passes great quantities of urine of low specific gravity. This causes excessive thirst, and makes it necessary for the patient to drink gallons of water daily. The condition may be either congenital or acquired.* It is hereditary in a number of cases. In Weil's case, cited by Bulloch (1909), J. P. Schwarz was born in 1772 in Oberhessen, and had 220 descendants in four generations. Thirty-four of them had diabetes insipidus. Three of his 5 children had the affection, 7 of his 29 grandchildren had it, 13 of his 66 great-grandchildren, and 11 of his 119 great-great-grandchildren. In four of the larger families, taken from the fourth, fifth, and sixth generations, the numbers of normals and abnormals were respectively: 4:4, 2:4, 2:3, and 3:4, making a total of 11:15. Hence the condition is, as usual, a Mendelian dominant. In this pedigree it never skips a generation, except in one recorded instance of an affected son (died age three) with normal parents. Occasionally other instances of skipping a generation are

* This is an excellent example of the same peculiar character being hereditary or not according to the manner of its origin—*i.e.*, as the result of a germinal change or an impressed modification.

recorded. Probably in such cases some favourable condition in the transmitting parent prevents the disease appearing.

Darwin, in his chapter on Inheritance, in the *Variation of Animals and Plants under Domestication*, refers to many cases of inherited abnormalities in man, but the knowledge of his time was insufficient to explain them, as they can now be clearly understood in the great majority of instances. He clearly recognises this when he states, "The laws governing inheritance are quite unknown."

Differences essentially chemical are also involved in many instances. The method of serum formation and precipitation has been used as a means of testing genetic relationships, both in animals and plants. Learmonth (1920) has made certain interesting observations in this connection. Human sera have been classified into four groups, according to their iso-agglutination* reactions. From a study of the iso-agglutinins in the blood of forty families of parents and children, it is concluded that two Mendelian factors, A and B, are concerned. Group I. contains both factors, group II. contains A, group III. B, and group IV. neither. These differences account for the violent reactions which frequently occurred after blood-transfusion before the introduction of blood-compatibility tests, since transfusion can only take place safely between members of the same group. With further experience the method will provide, in many cases, a test of the paternity of a child.

Among hereditary abnormalities referred to by Windle (1891) is polymastia or accessory breasts,

* An iso-agglutinin is an agglutinin capable of agglutinating the red blood corpuscles of other individuals of the same species as that in which it is developed. It is formed in the blood of an animal by injection of the blood of another animal of the same species.

present in several cases in mother and child; hypertrichosis or excessive hairiness, which is said to be usually associated with deficient dentition; and gluteal prominences, a racial character in Hottentot women. Congenital luxation (dislocation) of the femur was traced through five generations, and on both sides of the house. Cleft-palate and hare-lip are said to be undoubtedly hereditary, but many more data concerning their inheritance are required. Rischbieth (1910), in a study of these malformations, collated the data regarding their incidence. They are often associated. Frobelius examined 180,000 children in the Foundling Hospital of St. Petersburg during thirty years, and found one or both conditions in a total of 118 cases, or 0.066 per cent. Among 67,945 children examined at London Hospital in 1908, thirty-nine showed the deformity in one form or another, hence a frequency of 0.057 per cent. But this figure is too low, because some children attended more than once. The condition is said to be more common among defectives, and it is often, though not always, associated with other deformities.

Of similar origin are branchial fistula (failure of the branchial clefts in the neck to close before birth), and hypospadias (abnormal opening of the urethra), both of which show signs of being hereditary. Edentulism or partial absence of teeth, sometimes accompanied by a peculiarity of the hair, is hereditary, and was traced through four generations in one family, being accompanied by inherited polydactylism in the fourth generation. Among malformations of the eye, instances are quoted of microphthalmus, absence of iris, coloboma (failure to close choroidal fissure), congenital dislocation of the lens, and strabismus (squinting) being inherited through several generations.

There are many early records of hermaphroditism or allied conditions in man, many of which would

now be classed as intersexual. Metchnikoff (1903) concludes, from the presence in each sex of traces of the sexual organs belonging to the other sex, that at a very remote period the ancestral vertebrates were hermaphroditic, and that the sexes have only gradually become separated since. This is, however, a very doubtful line of reasoning. Bulloch (1909) shows that in man the condition may occur in several members of a family or in several generations, a fact which was known to Bauhin as early as 1614. But the known pedigrees are incomplete, and little is known of its inheritance. Blacker and Lawrence (1897) and Lawrence (1906) discuss the cases of "true hermaphroditism" in man. Thirty-three cases of hermaphroditism (intersexuality) are on record in the medical literature. Of these only five, and one which the authors describe, are regarded as true hermaphrodites, defining the condition as one in which the specific tissues of both ovary and testis are present in any amount. Anatomical details of these six cases, which vary greatly, are given. No other cases are regarded as fully proven. Human gynandromorphs, having male secondary sexual characters on one side of the body, and female secondary sexual characters on the other, are not unknown. Klebs classified "hermaphrodites" as unilateral, bilateral, and lateral.

In these individuals there is frequently a tendency for transformation from one sex towards the other during the lifetime of the individual, as shown both in behaviour and by anatomical examination. That hens with diseased ovaries take on male characters is, of course, well known. It is not our purpose to discuss the various causes and phenomena of intersexuality here, but it may be pointed out that there are several types of intersexuality in animals, in some of which there is transformation from one sex to the

other, while in others the intersexual condition is constant. Julian Huxley (1922) has discussed this subject. In *Drosophila* (Bridges, 1921) the sexual condition is shown to depend on a particular balance between the XY chromosomes and the ordinary chromosomes (autosomes), as shown by the fact that triploid individuals receiving only XX chromosomes through non-disjunction are not females but intersexes, while triploids with XXX chromosomes are ordinary females. Banta (1918), from his studies of sex intergrades in *Cladocera*, concludes that maleness and femaleness are not mutually exclusive states, but that strains representing every quantitative intergrade may be found. Crew (1921) and Witschi (1921)* have shown that in frogs a real transformation from females with ovaries to males occurs, and Crew in his studies obtained the remarkable result that such a transformed female mated with an ordinary female produces only females (774 offspring examined in tadpole and frog stage). This is, no doubt, because, notwithstanding the somatic modification of a female to a male, the structure of the germ plasm and the chromosome content (XX chromosomes) remain unchanged. It is not in this direction that any practical application to the human race is to be sought.

Shattock and Seligman (1906) describe a case of hermaphroditism in a two-year-old Leghorn fowl. The bird laid no eggs and did not crow, but it had the comb, wattles, and spurs of a male, but not its tail feathers. Both male and female genital ducts were present, with an ovotestis on the left side, and apparently a testis on the right side. The authors

* Swingle (1922) controverts Witschi's claim to have transformed female frogs into males, showing that "appeal to the somatic sex characters completely fails as proof of the transformation of female frogs into males."

discuss the occurrence of hermaphroditic conditions in reptiles, amphibians, fishes, and cyclostomata. Hanna (1921) states several interesting facts regarding hermaphroditism in seals. It is a rare condition in mammals, and has not been previously recorded in seals. Among 33,000 male seals killed on the Pribiloff Islands of Alaska in 1918, two were found to be hermaphrodites.

An American family is described by Goldsmith (1922) in which there are two round openings in the parietal bones at the back of the skull. These sometimes form a single opening in the younger stages, and in some cases it may later close up entirely. It is clearly a failure to complete development. In five generations of this family sixteen cases are known. The manner of its inheritance is not clear. Microcephalic people occasionally occur in families (Bernstein, 1922). There is often more than one such child in a family, but they seldom occur in successive generations, and nothing appears to be known concerning the inheritance of this condition.

Absence of the external ear is cited (Windle, 1891) in a case where a normal father had a son with the defect. The father's male cousin had the defect, and two of his male children, but a daughter was normal. A Mendelian dominant is suggested, a result which is especially interesting in the light of recent experiments with earless sheep, given below. Sedgwick (1861) cites a case of a boy with no external left ear, the meatus being imperforate. This boy's father had a male cousin whose two sons exhibited a deficiency of the cartilage of the left ear, while the daughter was normal. The manner of inheritance is not clear, except that it is from the original great-grandparents, and it is confined to one side of the head. In another case a woman, two of her daughters, and two granddaughters had rudimentary lobules

to their ears, the male children and grandchildren being normal. The rudimentary lobules probably represent the heterozygous condition, but there is not sufficient evidence of sex-linkage. Sedgwick (1863, p. 457) describes a line of descent in three generations with rudimentary ear-lobes adherent to the head. The condition appears to have occurred only in the women. It was present in the grandmother, in two of her daughters, the third not being examined, and one of the two sons examined being normal. One of the daughters who had the peculiarity transmitted it to her two daughters, the son being normal. No doubt many other ear peculiarities are inherited. The Kalmucks are said to have large and unsightly ears as a racial character.

Lynch (1921) describes a mutation in the house-mouse, in which the ears are about half the normal length and somewhat narrower. They also differ somewhat from the normal in outline, and are held close to the head. The character behaves as a simple Mendelian recessive.

Ritzman (1921) has found that short, thick ears in a breed of sheep is a heterozygous condition, giving equal numbers of both types of offspring in crosses with the normal (sixteen short ear: sixteen long ear). The mating together of short-eared individuals has produced an earless ram, which therefore clearly represents the pure recessive condition. Similar results have been independently obtained by Wriedt (1919, 1921), who adds that an earless ram mated with normal sheep gave five offspring with short ears, while an earless sheep mated with a normal ram produced one lamb with short ears. Earless individuals mated together gave earless offspring. Short ears in sheep were said to be very common formerly in Norway, and are still found in various parts of the country. There is evidence that both the short-eared

and earless conditions are found also in the Karakul breed of Bokhara.

Lush (1922) describes the inheritance of a notch in the lower margin of the ear in cattle. This character is found in a Jersey bull at the Texas Agricultural Experiment Station, and is inherited as a simple dominant, the bull (Gamboge's Raleigh) being heterozygous. Thirty of his calves were examined and twelve found to be without the notch. There is much variation in the degree of expression of the notch.

As an example of the inheritance of a slight peculiarity may be cited the case of a bilobed ear

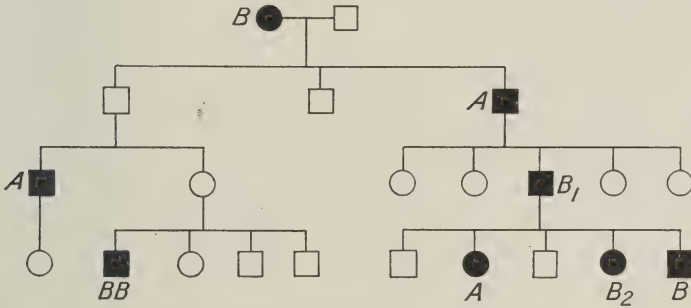

FIG. 27.—PEDIGREE CHART SHOWING INHERITANCE OF RIGHT BILOBED EAR.

described by Schofield (1917). In this family the condition has been transmitted through four generations, only the right ear having the peculiarity. The accompanying chart (Fig. 27) shows its incidence. One generation or even two may be skipped, and the condition varies considerably in different individuals. Thus, in A there is a very marked deep cleft of considerable length, while in those marked B the cleft is not so well marked. In BB it was only a furrow, while in B₁ and B₂ there is a deficiency of hearing in the bilobed ear. The family with pitted ear-lobes, described by Jenks (1916), is a similar case.

Kindred (1922) gives the pedigree of another family, in which a peculiar little pit occurs in the skin at the proximal end of the upper part of the helix of the left ear. This is known to have occurred in four generations, as is shown by the chart (Fig. 28).

The propositus (III. 7) has the pit, as well as her father and father's father. Some of her father's brothers and sisters probably had the mark, because some of her cousins were known to have it. Three of her sisters who married all had one or more children showing the mark, although two of them did not have the pit themselves. One of the most remarkable features of these slight peculiarities is their unilateral

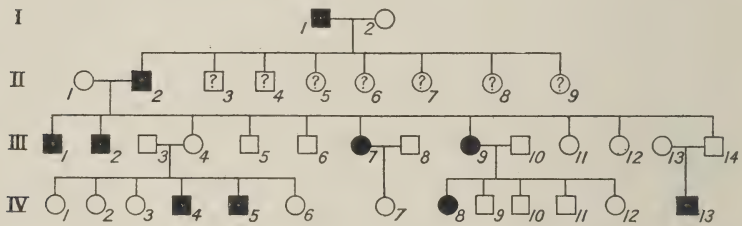

FIG. 28.—PEDIGREE CHART SHOWING INHERITANCE OF A SMALL PIT IN THE LEFT EAR.

occurrence, being confined to the right side in one family, and the left in another. We are at present at a loss to picture the hereditary mechanism by which this comes about.

Of a similar nature is the case (Sedgwick, 1863) of a Spanish nobleman who had one cheek bigger than the other. His father and some of his uncles had the same peculiarity. Another record of the same writer (p. 464) is that of a patient in St. George's Hospital in 1833. Neither he nor his father nor grandfather had a patella (knee-cap).

Drinkwater (1914) described an interesting case of bimanual synergia, in which the individual is obliged

to move both hands and arms in the same direction at the same time. Only four other cases of this rare condition are known in the medical literature, and they were all recorded in Germany. In Drinkwater's case, if the boy held a pencil in each hand and wrote with the right hand, the left would produce the same words in mirror image form. Attempts to move one hand when the other was held caused acute pain. This case was unique in that the synergia was accompanied by similar sensations in both hands when only one was stimulated, the unstimulated member feeling the sensation more intensely. Crossing of sensations also occurred. Thus, when a hot test-tube was held in the right hand, and a cold one in the left, the left hand felt hot and the right cold.

The motor phenomena in this case were traced through nine individuals occurring in four generations. The manner of inheritance is in harmony with that of a Mendelian dominant, except that one woman, four of whose ten children showed the condition, did not exhibit it herself. She probably, however, was affected in infancy and outgrew it. Every infant has to learn to use its right and left limbs independently, and this power of unilateral control develops earlier in some individuals than in others. One boy in this pedigree was able to overcome the synergia at the age of fifteen years, after repeated efforts. The condition is, then, essentially one of failure in development of a particular function.

Among many inherited peculiarities of the blood system may be mentioned one cited by Windle (1891) from the *Chicago Med. Journ. and Exam.*, 1879, p. 475. The radial artery of a male in both arms passed over the supinator longus muscle at 3 to 4 cm. above the wrist, and ran over the radial extensors above the styloid process to its normal distribution. All his children had the same abnormality on the left

side, and the daughters transmitted it better than the sons. Amongst the grandchildren it occurred in four on both sides, in four on one side, and was absent in seven.

Bronchial asthma and hay fever form a closely associated set of phenomena which are clearly inherited in families, and have their basis in the nervous system. Hay fever is a slight form of the condition, which may develop asthmatic symptoms under special irritation or lowered bodily vitality, and, as is well known, may appear or disappear in an apparently capricious manner at different ages or under different climatic conditions. A considerable study of asthma from the clinical and inheritance point of view has been made by Adkinson (1920). She studied 400 cases, and found a history of asthma in the family in 48 per cent. of the cases. Of the total, 191 were sensitive to proteins, as demonstrated by skin tests, while the remaining 209 were negative to tests. There was a larger percentage of inherited asthma in the former group.

The latter type or "sensitive asthma" is more like intensified bronchitis. Both types "run in families," and both usually occur in different members of the same family. Asthma is found to be inherited with equal frequency through either parent. Thirty-eight family histories are presented, and the general conclusion to be drawn from these is that the asthmatic tendency is inherited as a Mendelian recessive. Considering individual cases, "from the father's family 66 patients may have inherited asthma, 39 directly, 8 skipping a generation, 1 skipping two generations, and 18 collaterally. From the mother's family, 64 patients may have inherited asthma, 25 directly, 22 skipping a generation, and 18 collaterally." It is found that "a nearly equal number of men and women inherit asthma from the father, but twice as many women as men inherit asthma

from the mother, and 25 per cent. more women than men inherit asthma directly from the parents."

It is concluded (1) that where both parents have asthma or hay fever, all the children tend to show the condition. (2) Where one parent has asthma and one is normal (seventeen matings), all the children (sixty) were normal. (3) When one parent is asthmatic and one normal, but probably carrying the condition (simplex), then equal numbers of the offspring are affected or unaffected (sixty asthmatic and sixty-seven normal). (4) When both parents were normal, but could be shown or must be assumed to be carrying the condition (simplex), there were three times as many asthmatic as normal children. This is the reverse of expectation. It is partly explained by incomplete records of normals, and in part by the addition of the non-transmitting type of asthmatics. But it is at least possible that in a character of this kind, in the cross $DR \times DR$ the recessive character is able to express itself in some instances in the heterozygous condition. Whether this is the case can be determined from further evidence, but it appears probable that characters may depart from strict recessive Mendelian behaviour in this respect.

Reference may be made here to the studies of tuberculosis by Pearson (1907) and Goring (1909). They compared the correlation between parent and offspring as regards the incidence of the disease with that between husband and wife, in order to determine the relative importance of inheritance and infection in the development of this disease. Pearson found a correlation of 0.5 between parent and offspring, which is about the same as for such characters as eye colour, height, etc., indicating the same tendency to inheritance. Husband and wife, on the other hand, gave a correlation of 0.24, and much of this was believed to be due to assortative mating. Pearson's data

were taken from the upper classes. Goring studied British convicts, and also found a correlation of 0.5 for parent and offspring, but none for husband and wife.

Wright and Lewis (1921) have made experiments on guinea-pigs, in which they found marked differences in resistance to tuberculosis in a number of inbred families. The high resistance of one family was transmitted by either sex to the offspring in crosses with other inbred families. It is found that the factors determining resistance to tubercle are not closely related to the other elements of vigour, such as growth-ratio, adult weight, frequency and size of litter, percentage of young born alive, and percentage of young raised to weaning. Inbreeding brings out differences between families in these characters, as well as independently in resistance to tuberculosis.

Nothing very definite appears to be known regarding the relation of cancer to inheritance in man. In animals, however, many definite facts have been determined. These are referred to by L. Loeb (1921). The inheritance of specific kinds of cancer in rats and mice and other animals is known—*e.g.*, cancer of the inner canthus* of the eye in cattle, cancer of the scrotum in rats, and sarcoma of the thyroid in rats. Miss Slye has shown the inheritance of cancer of the liver and other special forms of cancer in certain families of mice. I am informed that the late Professor Plummer recorded cancer in three generations of wolves in the Zoological Gardens, occurring always in the same place—*viz.*, the shoulder. In the fruit fly, *Drosophila*, Stark found two kinds of inheritable tumour-like formations originating by mutation. Others have since been found. Since they cause death they are classed as lethal mutations. Loeb concludes that the endemic occurrence of cancer

* The angle next the nose where the eyelids meet.

in animals is due to hereditary transmission of the disposition to cancer. Infection from certain parasites may, in addition, act as an external stimulus, comparable with Röntgen rays.

Probably in principle the conditions are similar in man. Davenport (1918) shows that the tendency to neurofibromatosis* behaves as a dominant in heredity, though it sometimes skips a generation. It is a rare condition, being found in only one in 2,000 cases. Loeb believes that in man probably one or more factors are hereditarily transmitted which determine the intensity of the tendency towards cancer development. In many cases, cross-breeding appears to have equalised this tendency in man. But in stationary or relatively pure populations, as in parts of Norway, there is evidence of marked differences in the tendency to cancer in different strains and races.

Stammering is due to an unusual excitability or instability of cells in the speech centre of the cerebral cortex. The tendency to stammer is clearly inherited, although it not infrequently skips a generation. Bryant (1917), who has examined over 20,000 cases in a practice extending over thirty-five years, states that at least half had relatives who had suffered from some nervous speech disorder. The condition begins spontaneously in very young children beginning to speak. A case is cited of stammering occurring in four generations, but no other pedigrees are given.

The Jewish racial† physiognomy, which has been

* The formation of numerous tumours from nerves, and containing connective tissue.

† It is questionable in how far the Jews can be considered a distinct race. Like most races, they have had a mixed origin, probably from Armenoid and Hamitic stocks, as indicated by the presence of both round heads and long heads among modern Jews. The fair Jews evidently have an admixture of Nordic blood. See also Salaman, *Trans. Jewish Hist. Soc. Eng.*, ix. 163, 1922.

characteristic for over 2,000 years, is believed by Salaman (1911) to show in marriages with Gentiles incomplete or variable dominance and segregation. Thus, from such marriages 328 children were classed as Gentile in facial expression, twenty-six as Jew, and eight intermediate. The subject is one which invites more detailed study. Salaman points out two other inherited peculiarities of the Jewish race: (1) Amaurotic* family idiocy, a disease whose victims die in early childhood, and which is known only in Jews; (2) absence of alcoholism.

As our knowledge of the physiological controls of development in the human individual increases, a deeper analysis of many physical characters will become possible. Various abnormalities in man, such as brittle bones and blue sclerotics,† are already believed to be due to an hereditary inferiority of mesenchyme.‡ And the glands of internal secretion, such as the pituitary, pineal, and thyroid, are already known to control growth and to produce, by their presence in excess or defect, various characteristic conditions of the features or the limbs. Inherited differences in these glands may thus account for a whole series of changes, not only in physical conformation, but in temperament as well.§

What is often referred to as a remarkable feature of human inheritance, which is observed also and made use of in horse and cattle breeding (Hover, 1916), is the occurrence of "prepotency." Although

* Amaurosis is blindness without apparent lesion of the eye, resulting from disease of the optic nerve, retina, brain, or spine.

† The hard, white, fibrous membrane forming the outer coat of the eyeball, except at the front where it is replaced by the cornea.

‡ The embryonic connective tissue, which forms not only connective tissue, but also the bloodvessels and lymphatics.

§ This subject will be referred to again more fully later (see pp. 210, 219).

there are facts which bear such an interpretation, prepotency has not yet received a satisfactory biological explanation, nor is it clear that the biological facts require one. Prepotency is believed to be increased by inbreeding, and differences in vigour or energy are also believed to be involved (Popenoe, 1916). Mere dominance does not appear to be sufficient to explain it, and the interactions of factors may be concerned. The term should be used with great care, as no case of individual prepotency has yet been proved. Perhaps the most striking case in man is to be found in the offspring of the Mormon, Brigham Young (see *Journal of Heredity*, January, 1916). In a photograph of some eleven of his daughters by eight different wives each one seems to have been stamped, as it were, with the father's own image, though the resemblance is stronger in some cases than in others, but the characters of the other parent are by no means excluded. The resemblance is particularly striking as regards the strong, firm mouth, the ears, and the nose. But all the daughters are said, by one who knew the family, to be also musical, amiable, adaptable, genuine, sincere, warm-hearted, generous, attractive, magnetic and sympathetic, and temperamental yet reasonable. Moreover, all were good mimics and excellent cooks and housewives, having also their father's voice and temperament. This remarkable catalogue of qualities is very well substantiated by an accompanying photograph, which shows a group of motherly, kind-hearted women with remarkable similarity of features, although the mother's influence is also clear in the differences which appear between half-sisters. This resemblance is perpetuated in the grandchildren, especially the girls, and may be partly attributable to assortative mating.

Another question of heredity which I have not

touched upon here is the vexed question of functional inheritance, which has been fully discussed by MacBride (1917), and has been considered elsewhere (Gates, 1921) in some of its evolutionary aspects. The conceptions of Weismann regarding the insulation of the germ plasm and its immunity from bodily and environmental influence are now seen to have been too extreme. Recent experiments of Guyer and Smith (1920) are probably of significance in this connection. By injecting into fowls a finely ground suspension of the lenses of rabbits' eyes, they obtained a serum from the fowl which was then injected hypodermically into pregnant rabbits. The serum contained a cytolysin* which in a few cases more or less completely dissolved the lenses in the eyes of the embryo rabbits, although those of the mother were unaffected. Without any further treatment the condition was intensified in later generations, and was inherited through the male as well as the female. If these results were actually due to the treatment, as seems highly probable, they have an important bearing on the question of functional inheritance.

* A substance or antibody which produces dissolution of certain cells.

CHAPTER IV

INHERITANCE OF MENTAL CHARACTERS IN MAN

WHEN we consider mental and moral traits, the evidence of inheritance in many cases appears sound and beyond dispute, although in the matter of human character it is less certain how far the accidents of early environment may suppress or seriously modify the expression of various inherited traits. Here we are in a region where the structural basis of the developed inheritance is so tenuous, and the contact with the environment so intimate—character and environment becoming so mutually involved and interpenetrating—that it is conceivable that the laws applying to structural characters are not applicable with the same rigidity to the elements or methods of reaction that go to make what we call human character. Nevertheless, critical students of the subject speak with one voice, and it is quite certain that heredity plays an equally important rôle here also. Indeed, the statistical results of Pearson (1904) indicate that for siblings the intensity of resemblance is as great for mental as for physical traits. He chose eight physical characters—namely, health, eye colour, hair colour, curliness of hair, cephalic index, head length, auricular height, and athletic power—and eight “mental” characters: vivacity, assertiveness, introspection, popularity, conscientiousness, temper, ability, and handwriting. While many of these characters are not definite enough for anything like accurate measurement, and therefore have no decisive value, yet the coefficient of correlation

$$\frac{145}{77} \\ 68$$

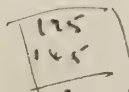

between brothers and sisters (siblings) comes out 0.51 for physical and 0.52 for mental characters. Schuster and Elderton (1907), from a statistical survey of Oxford class lists, attempted to determine the correlation in mental ability between father and son, and between brothers who attended the University. They found $r=0.312$ for father and son, and $r=0.405$ for brothers. They agree with Pearson that mental and physical characters are inherited with the same intensity.

Pearson has recently (1919) considered the subject again from different data, comparing the results of applying the Binet-Simon test (*a*) to children in orphanages in California, hence under nearly uniform conditions; (*b*) to children in schools of Great Britain, under the greatest variety of conditions of education and home training. Although the mental environment was relatively uniform in one set of data and diversified in the other, yet the correlation of intelligence between siblings was the same in both groups, the resemblance, $r=0.508$ in the Californian and $r=0.515$ in the English data, indicating that heredity and not environment determined the differences in all cases.

But the situation as regards some psychical characteristics is beyond our present powers of accurate analysis. This is probably because we have not yet learned to define psychic characters in biological terms. That psychologists are beginning to recognise the necessity for an analysis of the mind from the point of view of the inheritance of mental traits, is shown particularly by McDougall's book, *Psychology, the Study of Behaviour* (*e.g.*, p. 187). In writing of the very close resemblances in intellect and character which twins often show, he says: "The more children are studied from this point of view, the more far-reaching does the influence of heredity appear." At

the same time, he finds it impossible to define, except in the roughest way, the innate bases of these hereditary peculiarities. He concludes that we are compelled to believe they consist in "inherited mental structures of very considerable degrees of specialisation." McDougall points out that biologists and statisticians, in studying the inheritance of mental qualities, have frequently used crude and non-psychological popular distinctions, such as good temper, courage, conscientiousness, or popularity, and emphasises the need for accurate psychological analysis of the constitution of the mind as a basis for the study of mental inheritance. Biologists must undoubtedly look to psychologists for aid in this direction. In speaking of psychic characters we are not merely referring to the grosser mental differences, such as feeble-mindedness and the presence or absence of musical, mathematical, or general ability, whose inheritance is almost universally admitted; but to the less readily definable traits which go to make up what we call temperament, disposition, and character. These have not yet received adequate biological classification, treating them as methods of reaction; but such a scheme, combined with observations and comparison of the elements of human characters, would certainly help to clarify our conceptions concerning the basis of the differences involved.

May it not be also that in individuals who are heterozygous for various character traits which are alternative in inheritance, either method may come into expression according to circumstances? And since every individual may be supposed to be heterozygous for many pairs of traits of human character, it appears possible that mental traits generally differ from structural characters in that, in the former, all the alternative possibilities may come into expression in the same individual at different times, thus adding to

the complexity of the result. What we call human character in its developed form appears to consist in the acquired habit of inhibiting certain inherited tendencies, and giving free expression to others. But then, again, differences in powers of inhibition are undoubtedly inherited, and weakness in such powers may lead in the one extreme to vicious tendencies, and in the other to a free expression of the other elements of the inheritance. Nevertheless, there is always a choice of ideals to be aimed at, and it is necessary to distinguish in conduct between those who fail to reach their ideals and those who deliberately pursue non-moral ends.

The lay mind frequently goes astray on the question of the inheritance of ability by assuming that if the sons of an able father do not themselves show ability, this is a case of "failure of inheritance." In a scientific view of inheritance in such a case, one of the alternative factors has been inherited instead of that which conditions ability—an undesirable instead of a desirable quality has been handed on—or at least one of the necessary elements for the expression of ability is missing. In types of ability where the correlated action of several independent qualities or factors is required, the appearance of the same combination of exceptional qualities in the offspring is very likely to be infrequent, because of the presence of alternative characters in the germ plasm.

That the tendency to perform certain tricks when in a particular frame of mind may be inherited, was shown in a case cited by Darwin (*Animals and Plants*, chap. xii.) of a man who, as a boy, had the habit, when pleased, "of rapidly moving his fingers parallel to each other, and, when much excited, of raising both hands, with the fingers still moving, to the sides of his face on a level with the eyes." As a grown man the trick was with difficulty suppressed, but one

of his eight children, a girl of four and a half years, had exactly the same trick. Darwin states that imitation was out of the question.

Considering now the inheritance of various forms of mentality, Galton (1869), in his classical work, *Hereditary Genius*, first dealt with the inheritance of mathematical and various other forms of ability. This and the subsequent studies are too well known to require treatment here. Hurst first pointed out the probability that musical ability was a Mendelian recessive. The same is apparently true of feeble-mindedness, at least in its extreme form, two feeble-minded parents almost invariably having only feeble-minded children. The exceptions to the rule are probably explainable by illegitimacy. The literature of feeble-mindedness is too well known and too extensive for full discussion, but reference may be made to some of the results. For the Mendelian interpretation Goddard (1912, 1914) and Estabrook (1916) may be cited.

Goddard (1914) finds that at least 50 per cent. of the paupers cared for in American institutions are feeble-minded, and at least 50 per cent. of the prostitutes are estimated to be in the same condition. Many criminals come in the same class, and there is also a close relation between feeble-mindedness and alcoholism. On the basis of graded mental tests of the Binet-Simon Measuring Scale of Intelligence, individuals are classed as idiots when their mental age is 1-2 years, imbecile when it is 3-7 years, and morons when it is 8-12 years. The latter would be called feeble-minded in England. The mental development may stop at any age, and feeble-mindedness is essentially a condition of early suspension of mental development. Various accidents and certain diseases in childhood may result in feeble-mindedness, but it would appear that the great majority of cases

are hereditary. In hereditary feeble-mindedness the children tend to have about the same grade of mentality as the parents. Sometimes accidents in childhood reduce an hereditary moron to imbecility or idiocy. When their mentality is under five years, individuals rarely become parents, but parenthood with a mental age of seven or eight is common.

The careful training methods of the Vineland Institution show that it is impossible to develop a mind beyond its inherited capacity. The mental development may stop at any point, and training cannot push it any further, although the most patient and persistent efforts have evidently been made in this direction. When mental progress ceases, it is necessary to turn to manual training for any further development of the individual.

As regards inheritance, Goddard cites 42 matings, $NF \text{♀} \times FF \text{♂}$ —*i.e.*, a heterozygous but normal mother and a feeble-minded father—producing 144 children whose mentality is known. Of these, 71 were feeble-minded and 73 normal, almost exactly in accord with the Mendelian expectation of equality. On the other hand, from 6 matings $FF \text{♀} \times NF \text{♂}$ there were 193 children whose mentality is known, and they were 122 feeble-minded to 71 normal. Hence it appears that the number of feeble-minded considerably exceeds expectation when the mother is feeble-minded. Again, in $NF \times NF$ matings (26) there were 185 offspring, and the mentality of 122 was determined, 83 being normal to 39 feeble-minded (expectation for one Mendelian difference, 91.5:30.5). Among 476 children from $FF \times FF$ matings, only 6 are recorded as normal, and these were no doubt border-line cases, or perhaps illegitimate. Hence the evidence clearly favours the interpretation of feeble-mindedness as a simple recessive.

Holmes (1921) and other writers are less willing

to grant this conclusion. Holmes agrees with Pearson and Heron that feeble-mindedness varies continuously, but he admits that this does not imply "that the various kinds of mental defect are not transmitted according to Mendel's law." He nevertheless concludes (p. 39), "I very much doubt if the facts concerning the inheritance of mental defect are as yet known with sufficient precision to warrant our trying to force them into simple Mendelian formulæ." We cannot agree with his statement that "it seems improbable *a priori* that the inheritance of general mental development would follow the simple Mendelian formula for the inheritance of two contrasted characters." All sorts of physical defects in man and other animals, and in plants, are known to follow the behaviour of a simple recessive character. This appears to be due in each case to the fact that an altered element (gene) is present in a particular locus of a chromosome, and we find no difficulty in applying the same view to mental defects, which must have a physical basis.

We may, however, point out an inference which follows, and has not yet been generally recognised. If feeble-mindedness is inherited as a Mendelian recessive, this in itself furnishes evidence that it has arisen as a defect mutation from the normal condition. It has sometimes been suggested that feeble-mindedness represents the primitive condition of palæolithic man, which has persisted in certain strains through crossing while the gradual mental evolution of the remainder of mankind has continued. If the latter hypothesis were true, it is unlikely that simple alternative inheritance would result. On the whole, it appears most likely that feeble-mindedness has arisen many times, and may still arise, as a defect mutation in various stocks, although the condition itself may resemble in some respects the mental

condition of primitive man. Goddard cites a family of eleven feeble-minded children from two white feeble-minded parents. There were also two "normal" children, but they were black. The mentality of the negro is distinct from that of the feeble-minded. The latter presumably occur also in primitive races. The evidence, so far as it goes, also appears to indicate the gradual evolution of the mentality of normal civilised man, involving many steps, whatever may have been the forces involved.

Holmes points out that where a normal person married to a feeble-minded one has some feeble-minded children, it is too easily assumed that the normal parent was heterozygous for this defect. If this were always true, it would give a very high frequency for the occurrence of this latent defect (see p. 159). It seems much more likely, as Holmes points out, that the normal mentality shows variable or incomplete dominance, especially when, as is usual in such matings, the normal parent is also intellectually below par.

Goddard estimated the number of feeble-minded in the United States at 300,000 to 400,000. He thinks it important that the public should understand the mentality of a moron (mental age ten), and employ him accordingly, recognising his limitations. The moron has a lifetime in which to learn to do efficiently things that can be done by a boy of ten. Goddard suggests that their training should be carefully arranged according to mental age tests, that as many as possible should be "colonised," some sterilised, but the great mass "educated" for their proper work.

The "Mongolian" is a well-defined type of mental defectiveness, which has generally been regarded as non-inherited. The oblique eyes and round faces of Asiatics are combined with short stubby fingers, rather dry rough skin, poor circulation, lack of

occipital prominence, and usually in older cases a deeply furrowed tongue. The mentality is nearly always that of a four-year-old child. Mongolians usually appear in good-class families, they are not associated with feeble-mindedness, and are frequently the last born in large families. They probably result from derangement of function (uterine exhaustion) leading to arrest of development, beginning at a definite point in the prenatal development. The causation of the type according to Goddard (1914) appears to be purely physiological, without any element of inheritance. Probably defects of certain internal secretions are involved. It has recently been claimed, however, that there is some reason for regarding Mongolianism as a recessive Mendelian trait (see Davenport, 1920). There is evidence also that idiocy frequently results from a severe infection, from cerebro-spinal meningitis, or from syphilis, alcoholism, or addiction to drugs on the part of the parents. But, according to Davenport (1920), statistics show that the great mass of idiots arise from feeble-minded parents.

The controversy between the schools of Pearson and Davenport turned on the terms in which the inheritance of feeble-mindedness is to be stated. Both agree that the condition is inherited. It is possible that the inheritance is not always strictly Mendelian, although it appears to be usually in conformity with the simple Mendelian scheme. It would appear that occasional departures from strict conformity with the Mendelian scheme may be expected in connection with the inheritance of mental characteristics. Nevertheless, it must be remembered that with feeble-mindedness, as with other Mendelian characters, the expression of the inheritance may be modified by the presence of other determiners. It is also possible that the inheritance follows different

rules in certain families, as is known to be the case with other Mendelian characters. For example, if a defect has arisen in an ordinary chromosome, it will be inherited probably according to the simple scheme of a Mendelian dominant or recessive, but if it has arisen in a sex chromosome it will be sex-linked.

We have already seen that feeble-mindedness is essentially a condition of arrested mental development. Epilepsy is a closely related neuropathic condition. Insanity is more variable in its causes, and is not always inheritable. Many data on the inheritance of mental defects are given by Guyer (1916).

The relations between feeble-mindedness and insanity have frequently been misunderstood. From

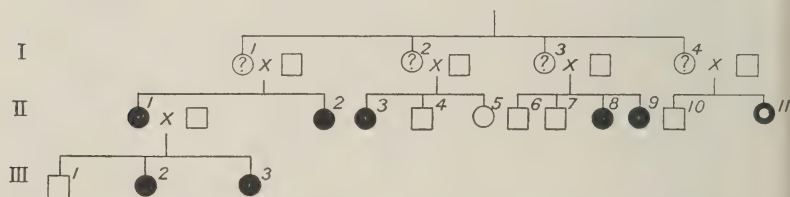

FIG. 29.—HEREDITARY IMBECILITY IN THE FEMALE LINE.

the point of view of the Binet-Simon tests, while feeble-mindedness gives general arrested development at a certain level, insanity and epilepsy show "scattering" in the tests—*i.e.*, in the diseased brain some questions in various years will be missed. "Scattering" in tests of the feeble-minded indicates the oncoming of insanity, which may not become evident for several years. In many respects feeble-mindedness and insanity are at opposite ends of the mental scale, although an unusually high percentage of feeble-minded become insane. Psychiatrists maintain that insanity comes in highly developed nervous systems, which are easily thrown into an abnormal condition. Morons, on the other hand, represent often a vigorous

organism of low intellect and strong physique. They often have exceptional strength, but cannot show it on a dynamometer because of lack of will power. They represent a more primitive type, with dullness to pain, etc., but under exceptional conditions they may perform surprising feats of strength.

Sedgwick (1861, 1863) records many instances of the inheritance of insane diatheses. In one family (Fig. 29) hereditary imbecility appears in nearly all the females of two generations, while the sons were normal. No. II. 3 was eccentric and silly, while No. II. 11, though not an imbecile, was a religious fanatic and became a Mormon.

Inspection of charts does not convince one that insanity in the ancestry has any potent influence towards causing feeble-mindedness. On the other hand, the feeble-minded not infrequently have insane offspring. Insanity is a symptom of nervous derangement which will occasionally give rise to feeble-mindedness. Thus, Goddart cites the case of Nora T., age thirteen years, mentality three. Her father and mother were both normal, but the feeble-mindedness in the father's family and the insanity in the mother's family apparently brought about the result in Nora. Again, Bessie X. has a cousin who is epileptic and a number of distant relatives who are insane or epileptic, while others are "queer" or "peculiar." She is fifteen, with a mentality of two, and her condition is looked upon as a summing-up of various morbid tendencies which have appeared sporadically in several generations of her ancestors.

It is worth noting that the drawings of animals by the feeble-minded sometimes remind one in style and method of some of the cave drawings of early man.

While feeble-mindedness is certainly far removed from genius in the mental scale, representing a primitive undeveloped mental condition, it is often

but a step from insanity to genius. Indeed, many geniuses would pass with any psychiatrist as true insanities. The diagnosis may depend on whether the aberration is useful or dangerous. But it is impossible to graft genius on to feeble-mindedness, and the loss of a whole feeble-minded stock would not involve the suppression of a single genius. For in feeble-minded families even the "normals" are usually of low-grade intelligence, and they are as a rule correspondingly low in social grade. Notwithstanding this, it is clear that the condition of the feeble-minded does not result from their environment, but rather that their lack of capacity causes them to gravitate into squalid conditions, since they cannot grapple adequately with the complexities and subtleties of modern civilised life. Urquhart (1909) classifies insanity as melancholia, mania or dementia which are acquired, and idiocy and imbecility which are congenital. The latter conditions are, usually at least, accompanied by gross physical deficiencies. The pedigrees of insanity are usually unsatisfactory in failing to distinguish between different types, and so they give no general rule of inheritance, although many of them run through three generations.

Holmes (1921) has pointed out that the germ plasm of neurotic stocks may be affected in a variety of ways in different individuals. He says (p. 49): "Charts of the inheritance of insanity show that the afflicted individuals exhibit a great diversity of symptoms in successive generations." Particular types of insanity, however, tend to run in certain families. This is particularly true of dementia præcox (see p. 158) and periodical insanity. Unlike most forms of insanity, Huntingdon's chorea* appears

* Chronic chorea or St. Vitus' dance is a convulsive nervous disease with irregular movements, dementia, and disturbance of speech.

to be usually a typical dominant character in inheritance. While the feebleminded may be considered to form a graded series, insanity is much more varied in its manifestations, and is to be regarded as a pathological condition working havoc with the normal mental mechanism, rather than a simple defect of mental machinery. Some types of insanity may only appear late in life and yet are inherited, showing that the seeds of ultimate derangement are present in the germ plasm. In other cases, an exceptional mental or physical strain may bring out phenomena of insanity which would never appear under ordinary circumstances.

Ordahl (1919) made a study of fifty families in California containing feeblemindedness. He concludes that the parents of the feebleminded are often borderline cases and escape detection by ordinary means. Seventy-two per cent. of the fifty families showed defective inheritance. Of the living children, 5.6 per cent. were idiots, 15.6 per cent. imbeciles, 26.2 per cent. morons, 3.1 per cent. dull normal, 1.2 per cent. psychopathic, 48.1 per cent. normal. Ordahl believes that the moron and dull normal can be detected by expert means in the early school years. Otis (1916) aims to reconcile the views of Pearson and Davenport. He considers it important to distinguish between intelligence and "brightness"—*i.e.*, the degree the child is in advance of the normal development of intelligence. Pearson showed that all degrees of intelligence (meaning brightness) exist, but this does not exclude the Mendelian inheritance of any degree when mated with feeblemindedness. Otis concludes that "the existence of all grades of brightness, and the possibility of the universal Mendelian inheritance of different grades of brightness, are therefore seen to be entirely compatible." This is in accord with much other Mendelian behaviour.

A mental disorder which appears to be confined to Russian Jews (see Davenport, 1920) is amaurotic family idiocy, which runs in families and appears to be a simple Mendelian recessive. Myoclonic epilepsy (see p. 108) has been shown by the extensive pedigrees compiled by Lundborg in Sweden to be inherited in the same way. It is recognised that epilepsy occurs in a great variety of forms, and the pedigrees studied by Davenport and Weeks and others indicate that the common form at any rate follows the same rule of inheritance. A relation between epilepsy and feeble-mindedness is also indicated, such that if one parent is epileptic and the other feeble-minded, all the children will be either epileptic or feeble-minded. Various investigations indicate (Davenport, 1920) that dementia præcox* may be also a Mendelian recessive. According to F. W. Mott (*Proc. Roy. Soc. Med.*, June, 1920), this condition is accompanied by a complete arrest of spermatogenesis. Rüdin (1916) finds that various other psychoses accompany dementia præcox, and thinks that a Mendelian explanation is possible. Hoffman (1921), in a study of dementia præcox and the manic depressive condition, concludes that two factors are involved in the former, while in the latter a dominant character in some form is concerned. Siemens (1921) gives a list of inherited abnormal physical and psychical conditions.

The appalling frequency of feeble-mindedness in some parts of America is to be seen from statistics collected (Sessions, 1917) in one county in Ohio, where the feeble-minded number 1 per cent. of the population. An equal frequency throughout the State of Ohio would mean 47,000 feeble-minded within its borders. The rapidity with which the problem is becoming still more serious is to be seen from the

* Adolescent insanity marked by melancholia and other emotional states.

fact that "one feeble-minded man left at large five generations ago is responsible for seventy-five feeble-minded persons living at the present time." The normal population of the country, apart from immigration, can hardly have increased to anything like the same extent during this time.

But even if all feeble-minded individuals were prevented by segregation from multiplying, the most difficult part of the process of eliminating feeble-mindedness from the germ plasm of the population would scarcely have begun. For, as East (1917) has pointed out, while the number of feeble-minded in the whole population of the United States may be estimated at 3 per 1,000, the number which are carrying feeble-mindedness as a recessive defect must be nearer 1 in 14. Punnett (1917) puts the number even higher, and emphasises the impossibility of greatly reducing feeble-mindedness in the population, except by segregating also those who are carriers of the disease as a recessive quality. He shows that if the proportion of the feeble-minded in the United States is now 3 per 1,000, then it would require 250 generations, or about 8,000 years, to reduce the proportion to 1 in 100,000 by the method of merely segregating or sterilising those who show the character. It is evident, then, that the elimination from reproduction of those showing any recessive racial defect merely prevents the problem from becoming more serious, while marked improvement in the germ plasm of the population can only be effected by selection against the heterozygotes, who are carrying the defect in half their germ cells. More accurate mental tests may make it possible to distinguish such heterozygous individuals from the fully normal members of the population. This has happened in the history of the study of many Mendelian characters. From this point of view, any tendency for those transmitting

feeble-mindedness to intermarry will have the desirable effect of bringing it to the surface where the individual can be segregated, rather than spreading the condition subterraneously by marriage with sound stocks.

That even the most degraded family is not entirely incapable of better things in any of its members is shown by the recent history of the notorious "Juke" family (Estabrook, 1916). This family, whose history has been a continuous record of crime, vice, and feeble-mindedness, dates from 1720-40, and has been an untold burden upon the State. Dugdale published a history of it in 1877. Estabrook shows that, in their history, out of 399 fertile marriages about 176 might be classed as eugenic matings and 223 as cacogenic. Fifty-five per cent. of these matings should have been prevented, even putting the eugenic standard as regards intelligence very low. Had this taken place, the remainder would now show less than 5 per cent. of offspring with undesirable traits. In fact, over half the total offspring are mentally defective or have antisocial traits. The occurrence of both desirable and undesirable individuals in the same sibship is often startlingly clear in these families.

Eugenic studies have been made in America of the Edwards, Jukes, and Kallikak families, the Hill Folk and the Nam family. A more recent study of a Pennsylvania family containing good and bad elements has been made by Miss Key (1920). Two pioneer families of German descent are traced through five and six generations on American soil. They mostly belong to the great middle class, containing no eminent members and no notorious criminals. The study began with four young feeble-minded in a Pennsylvania Institution. The history of this family, with a network of descent including 1,822 individuals, shows the establishment of lines which vary greatly in social efficiency. Marriage selection has given

rise to three strongly contrasting lines, the original defects persisting or becoming accentuated in some lines, while marriage into better strains has produced other lines socially more efficient. One family began with a German and his wife, who immigrated into Western Pennsylvania in the latter part of the eighteenth century. He was a fair specimen of the pioneer type, but his wife was totally lacking in any sense of number or quantity, and could neither sew, spin, nor weave acceptably. They had children, three of whom were apparently feebleminded, while the others, through marriages with different types, established various lines, some of which split up into divergent branches. Five separate strains are traced in this family. Another German immigrant and his wife, about the same time, had twelve children. They were very tall and possessed great strength, qualities which some of their descendants perpetuated. Six of the children formed socially efficient strains, four died without marrying, while two daughters, the dullest and slowest of the fraternity, but with great strength and endurance, married into defective stock belonging to the previous family, and gave rise to an undesirable strain.

The characteristics of the various lines are determined by the combination of traits carried by their founders, together with the leading traits of the strains into which they married. There is a sifting out in every generation. Where weakness marries strength the defect may appear, but in lessened degree. This results in the practical elimination of some defects (in their external expression), and in increased efficiency. The intermarriages of defectives, on the other hand, give a continuous line of defectives requiring institutional care. Two of the lines continue to be mixed, showing defectives, degenerates, and socially fit. The degenerate branches gravitate

162
68
94

downwards, and produce nothing but degeneracy. The rapid multiplication of these people is most serious. Miss Key points out that public opinion is helpless to prevent marriages between them, and suggests State control of marriages through a State Eugenics Board, with power to prohibit certain unions under penalty after studying the hereditary defects of the proposed parties to a marriage. But it is not to be expected that a ban on marriage would prevent people of this type from reproducing themselves. It is noticeable that while defective members of these stocks remain for the most part within a few miles of their place of origin, and hence tend to establish a defective group in the community, the better members, by marriage or otherwise, remove to greater distances and a new environment.

Various attempts to analyse temperaments and their inheritance have been made, notably by Davenport (1915). He divides temperaments into hyperkinetic or nervous and hypokinetic or phlegmatic, and recognises two grades of each. A dualism of this kind, romantic and classic types, radical and conservative, feebly and strongly inhibited, he finds running through the whole population; also a tendency for matings to take place between unlike temperaments. He hypothecates a factor E producing periodic excitement, its absence *e* producing calmness. Another factor C makes for cheerfulness, while *c* permits more or less periodic depression; and he finds that C and E are independently inherited. As a modern attempt in the anatomy of melancholy, this shows courage in the effort to explore a field which is notoriously full of pitfalls. That it is inadequate as a complete analysis appears obvious. The desirability of creating "factors" for calmness and cheerfulness appears very doubtful.

Nomadism, or the wandering instinct, Davenport

(1915) treats as a fundamental human instinct, which is typically inhibited in intelligent civilised adults. It appears to be a sex-linked recessive monohybrid trait. Sons are found to be nomadic only when their mothers belong to nomadic stock. Daughters are nomadic only when the mother belongs to such a stock and the father is also nomadic. The impulse occurs frequently in families showing such periodic behaviour as depression, migraine,* epilepsy, and hysteria. Nomadism would appear to be more widespread in the Anglo-Saxon population of North America than in the resident population of Britain. This is probably because emigration has always been more largely of the roving types, the more sedentary elements of the population preferring to remain behind. This difference probably applies chiefly to the labouring and agricultural classes, the higher classes being able to satisfy their nomadic instincts by travel.

The relation of criminality to inheritance is often debated. Obviously it cannot be a simple one. Davenport (1920) classifies antisocial behaviour as due to one of the following four sets of conditions: (1) Ignorance of the mores (or social requirements), merely through lack of opportunity to learn the mores. This condition would apply partially to the foreigner, or to the improperly or insufficiently taught offender. (2) Ignorance of the mores through lack of capacity to understand what society expects. This is characteristic of the feebleminded. (3) Knowledge of the mores, accompanied by a social blindness and inability to have the action controlled by a knowledge of what society expects of one, because of lack of gregarious, social, or altruistic instinct.

* A nervous affection marked by periodic headache, often confined to one side of the head, and accompanied by nausea and other symptoms.

Here belong the extreme individualists and anarchists. (4) Knowledge of the mores with presence of the social instincts, but with inability to meet the expectations of society through insufficient inhibition or self-control. This insufficiency may be general and permanent, or it may be temporary (periodic). This would include the hyperkinetic, the hysterical and epileptoid offenders. It is thus evident that a tendency to the inheritance of criminality will vary according to its type.

Another work by the same author (1919), on heredity in naval officers, contains genealogical and biographical data of many English and American naval officers, including Raleigh, Hardy, and Nelson. Its attempt to treat thalassophilia, or love of the sea, as an inherited trait is not very happy as a means of analysing the inheritance of men who were, in many cases, remarkably diverse in their exceptional qualities. The Mendelian conception is valuable in connection with so many human traits, that it would be unfortunate if any loose and unjustified usage of it, as in the present instance, without any adequate understanding of the nature of the differences involved, should have the effect of throwing doubt on the many cases, mental as well as physical, of Mendelian inheritance in man. It is clearly a matter of greater difficulty to prove the Mendelian inheritance of a mental than of a physical trait, and correspondingly increased caution is necessary.

A very good summary of the general arguments in proof of the inheritance of mental traits is given by Popenoe (1916). Failure to recognise the fact of mental inheritance comes largely, now, from certain psychologists and educationists whose biological ignorance and lack of understanding of heredity are a matter for commiseration. Many psychologists,

however, now clearly recognise the inheritance of mental traits. That mental traits are inherited in animals has been clearly shown in one case by Castle, who proved that in crosses between wild and tame rats wildness is transmitted by the father to offspring who have never seen their father or had experience of any behaviour but that of their tame mother. Those who deal with psychological tests of such animals as rats and mice soon learn to recognise individual differences in psychology which make the simple tests of efficiency, such as maze-running, appear entirely inadequate unless careful allowance is made for such temperamental differences.

Modern psychology has developed in two directions, which tend to make it more biological and are of interest in connection with the present discussion: (1) The theories of Freud and Jung dealing with the formation of mental complexes, unconscious suppression, mental conflicts, etc., and tending to show that mental experiences very early in life, and quite unperceived at the time, may have a profound influence on the later mental development; (2) behaviourism, which has grown out of the purely zoological experimental study of animal behaviour, from protozoa to the anthropoid apes. The second phase need not particularly concern us here. A very good summary of the Freudian phase has been written by Tansley (1920). Instead of man being the rational, thinking being the older psychology pictured him, his mentality is seen to be built up on a mass of instincts inherited from his animal ancestry, giving him tendencies or instincts which constantly require to be altered or repressed under the conditions of civilised life. When not repressed, he acts first, and rationalises his action afterwards. This repression, often unconscious, may lead to subconscious mental conflicts and other difficulties. Kempf (1921) shows

how the bodily functions have their effect on the mind, and any defect is unconsciously compensated for by the individual. This may ultimately lead to a pathological condition of the mind, in other words, insanity, particularly in a time of mental stress, and under some conditions a psychoanalysis may restore the mental balance. The development of insanity is thus closely wrapped up with bodily conditions. That there is also an element of inheritance in many cases of insanity is undeniable, but it remains to be determined precisely what that element is in different cases. The situation is obscure in comparison with feeble-mindedness where the nature of the inheritance is clear. Insanities also show a greater variety of types, and they cannot be graded in a simple series like the mental-age series of the feeble-minded. The compelling force of the excessive development or derangement of some autonomic bodily function will usually furnish the immediate cause of an insane manifestation. Various inherited derangements of the nervous control of the body may then provide the basis for the development of an insane diathesis.

Inherited mental differences, no doubt, go back to germinal changes affecting the nervous system. Traced backwards in the ontogeny, they must have a purely physical basis like other germinal changes.* The description of a breed of goats in Kentucky (Hooper, 1916) is instructive in this connection. When frightened, their forelegs become stiff, and they hop along, dragging their hind legs. If much frightened, the latter also become stiff, and the animal falls over. Such a breed must have arisen through a germinal change affecting chiefly the nervous system.

* Yerkes has shown that in crosses between wild and tame rats wildness will appear in the offspring even when the father was wild and the young were reared by tame mothers.

A very similar condition appears in sheep, and also in horses and cattle, as a result of feeding too freely on pampas grass, *Poa argentina* (Jones and Arnold, 1917). But it is a form of intoxication, and is not inherited. Cole (1920) describes in guinea-pigs a form of congenital palsy which is not exactly like any nervous disorder in man, though it resembles ataxia in pigeons, which Riddle finds is a recessive character with some irregularities in inheritance. Congenital palsy in guinea-pigs runs a brief course, ending in death at an early age. The neurosis appeared in 1914, and is characterised by clonic spasms,* particularly of the legs, in which the animal lies helpless. It is inherited as a simple Mendelian recessive, heterozygotes being entirely normal. Hurst states that " feeblemindedness " in pigeons is a recessive. Tumbling in pigeons and " waltzing " in mice and rats (again recessive) are other examples of inherited nervous disorders in animals. These defects have been shown to be due to defective semicircular canals.

The inheritance of wildness in rats has been referred to elsewhere. Yerkes (1913) made a study of wild and tame rats and their F_1 and F_2 hybrids. He proved that wildness, savageness, and timidity are inherited, although wildness and timidity are very difficult to distinguish. Coburn (1922) has made a study of 1,300 mice, hybrids between wild and tame, in three generations. He made careful psychological tests of his animals, and concludes that the inheritance of wildness and savageness in mice is Mendelian of the " blending " or multiple factor type, but much more work is needed before the precise manner of inheritance can be stated. He thinks, however, that the two behaviour complexes, wildness and savageness, result from several different

* Spasms in which rigidity and relaxation succeed each other.

inheritance factors which appear to follow Mendelian rules.

Modern psychology is only beginning to recognise the importance of the inheritance element in mental differences. McDougall (1919) clearly recognises such an element in inheritance, but many psychologists are still too engrossed with the mind itself to recognise the genetic relationships of its various elements to the minds of relatives. Psychopathologists also frequently fail to appreciate that any element of mental inheritance exists. For example, Kempf (1921) studies the development of the mind with a complete disregard of the facts of mental inheritance. He devotes forty pages to an analysis of Darwin's mental development from the psychoanalytical point of view. We hear nothing at all of the inheritance of mental traits, but everything is explained on the basis of the mental relationships between Charles Darwin and his father, the early influence of his mother (who died when he was eight years of age), and afterwards of his wife. He sees in Darwin's mother's "charming interest in nature," her "romantic fondness for flowers," her keeping of pigeons, and her interest in the theories of her father-in-law, Erasmus Darwin (author of *Zoönomia*), a basis for Darwin's interest in nature. This inspired her son to search for "the secret of her fascination." At the age of eight he had already begun to collect "all sorts of things." The writer mentions that collecting was a characteristic of several of Darwin's uncles, but fails to recognise any element of inheritance in the reappearance of this trait. It seems more probable that Darwin inherited this quality, than that it was based on the development of a childish fantasy which originated through his mother's influence on his early mental development.

Granting that Darwin's mother's "charming in-

terest in nature " was a fact, this interest may have been a portion of her son's inheritance. Kempf (p. 216) implies that the mother had unconsciously " named her wish for her boy's destiny," and that this early attachment to his mother had influenced the whole course of his life, preventing him from following his father's and grandfather's profession of a physician. But Darwin's attachment to his father, who survived to influence him throughout his development, seems to have been equally strong. It seems, at least, very unlikely that Darwin's mother-attachment was the basis of his attraction to natural history. Rather his taste for natural history appears to have represented the inevitable expression of an inherited tendency, a tendency which finally overcame all obstacles and found an environment (the *Beagle* voyage) where it could develop freely. There are many similar instances of exceptional men whose development necessitated the overcoming of parental wishes. The recognition of Darwin's inheritance, which made his greatness possible, does not lessen the importance of parental attachment as a guide in development, or in some cases a hindrance if unwisely exercised.

Kempf goes on to consider Darwin's later chronic ill-health. He thinks Darwin suffered from an " anxiety neurosis, due to consistent affective suppression," from anticipation of what his work would mean to civilisation, the criticisms and opposition it would arouse. Although Darwin suffered from seasickness and dizziness during the voyage, yet his first experience of becoming " unwell " was after his return, and in his early life he was very vigorous and fond of sports. " The later course of his anxiety indicates that it was a reaction to his efforts to adjust himself to his career, his father (who had opposed the voyage on the *Beagle*, and wished him to take up

a church career after his failure to be interested in medicine, and on whom he was economically dependent), and his mating." The necessity for avoiding conflicts in order not to be distracted from his researches was another element in his adjustment. Of course, Darwin's ill-health has been much written about. This brief account is given as a typical example of the psychoanalytic method applied to a man of genius. It would gain greatly in value if it recognised the importance of inheritance as furnishing the potentialities on which environmental influences play. It ought to be obvious that if Darwin had been a person of mediocre ability, neither his mother attachment nor anything else could make of him a great naturalist. It is this fact which the psychologist too often overlooks.

As regards the inheritance of mental aptitudes, that musical ability "runs in families," and is more frequent in some races than in others, is well known. Not only is this true of such groups as the Bach family, but also of innumerable other families of less exceptional musical ability. Hurst first suggested that this characteristic was a Mendelian recessive. A study of five musical families by Drinkwater (1916) partly supports this conclusion. A family of organists was traced through several generations, and in every case where both parents were musical all the children showed musical ability. In another branch of this family, where both parents lack musical ability, all the children lack it. These families were united by marriage, but instead of all the children being non-musical, exactly 50 per cent. of them were musical, two being professionals of great ability. It therefore appears that musical ability may be a recessive which may nevertheless appear in some cases in the heterozygous condition. Artistic ability was also traced through four generations as a recessive

character. But further evidence is required for clear conclusions regarding the inheritance of musical and artistic ability.

Miss Stanton (1922) has made records of the musical capacities in various American families containing one or more distinguished musicians. The measures of musical capacity used were (1) sense of pitch, (2) sense of intensity, (3) sense of time, (4) tonal memory. These are believed from extensive experimentation to be basic qualities in connection with musical ability, being little affected by practice, age, musical training, sex, or general intelligence. Discrimination tests were made on the basis of phonographic records and standard laboratory apparatus, 531 individuals being classed as poor, average, superior, etc., on the basis of each test. As regards inheritance, the results are not extensive enough to warrant any very definite statement of laws. It is nevertheless suggested that the data indicate the dominance and segregation of superior capacity from average and poor capacities. It is concluded that "the inheritance of musical capacities seems, indeed, to follow Mendelian principles, but the method of inheritance is so complex that it is impossible now to state how many factors may be present." It is doubtful if such a result has much value, beyond the recognition of the fact that degrees of musical capacity are probably inherited.

Pearson treats handwriting as a mental characteristic. There is no doubt that it is an extraordinary index of human character,* and can be used for an intimate analysis of the character by one who is expert in the comparison and analysis of different types of cheirography. There is nothing mystical in this relationship. The handwriting is an ex-

* This statement has often been disputed, but from personal experience I am convinced that it is a fact. See also p. 172.

pression of one's manner of doing things. It may be neat or slovenly, run together or disconnected, large and showy or small and carefully formed, with long loops, precisely crossed t's, large capitals, long flourishes, etc. In the hands of an expert these, and many much more minute details, yield a remarkably accurate analysis of the character and capacities of the individual. The autograph is truly the product of the whole man. If you write another man's name you will write it differently from his autograph, unless your characters resemble each other, in which case you may form the letters in a very similar way. There is one man whose name I write almost exactly as he does, and I know that our characters have many points of resemblance.

The analysis of this relationship between character and handwriting, a relationship which extends to the minutest details, is worthy of scientific study. I know of one woman, a teacher, who is almost infallible in delineating the character of any person whom she has never seen, from only a few lines of the handwriting. It seems to be a matter of sensing the significance of different types of curves and various other features of handwriting, as they blend together in the expression of the character of the individual. The mood of the individual, whether elated or suffering from depression, is also registered in the handwriting. Indeed, the method is so accurate that specimens of the handwriting could undoubtedly be used to determine the character-traits of deceased persons concerning whom insufficient evidence is available in the study of mental inheritance. The striking resemblances one sometimes sees in the handwriting of relatives is associated with inherited similarities in character. Identical twins, however, sometimes show fairly marked differences in handwriting. This subject of the handwriting of twins.

is worthy of further investigation. It should throw light on (1) the similarities between twins; (2) the limits of relation between handwriting and character.

Another important fact which the student of eugenics must needs bear in mind is not only that a vast array of biological character-differences exist, which are being reshuffled from generation to generation, but that in the individual the greater number of these characters will be in the heterozygous or hybrid (*i.e.*, inconstant or splitting) condition. This has both advantages and disadvantages from the point of view of selective mating and offspring. Among the advantages may be reckoned the fact that the offspring are sure to show a variety of mental and physical characteristics—*i.e.*, to differ markedly from each other (except in the case of identical twins); while the disadvantage is measured by the number of unfavourable recessive characters carried by both parents. The fact that both parents may be carrying some of the same unfavourable or deleterious recessive characters is the chief and probably the only sound biological argument against cousin marriages. Here it may be pointed out, that while it is impossible to know with certainty from a human pedigree all the recessive characters which are carried by an individual, yet it will be possible to determine some of them from a study of the ancestors, and particularly of the collateral lines, such as uncles and cousins and their families.

Eugenic action should, then, be based upon four separate factors: (1) Positive selection for desirable qualities, which are frequently dominant; (2) negative selection against undesirable recessive qualities which appear in collateral or ancestral lines, and may therefore be carried in the family germ plasm; (3) isolation of individuals having undesirable dominant qualities; (4) correlated with this should be an effort to foster matings between individuals

showing the same desirable recessive quality. All this implies an array of information more elaborate than anyone possesses concerning his own ancestors and more distant relatives, unless he has made exceptional efforts to collect and compile the necessary data from ancestral records, portraits, and other sources. It will also be understood that although I have here spoken of dominant and recessive characters as though the difference between them were absolute, yet it is well known that in many instances this is not really the case. It is quite likely that in man the interrelations with other germinal qualities may bring about variable dominance; and the heterozygous combination of a pair of characters much more often gives an intermediate result, or at least one in which the recessive exhibits some tangible effect of its presence. Even in the case of such abnormalities as brachydactyly, which are commonly treated as dominants, there is some evidence that the homozygous condition of the abnormality is much more extreme, and indeed non-viable (see p. 90). If this is the case, it shows incidentally that the original mutation must have been itself heterozygous. It also follows that the heterozygous condition is intermediate between the normal and the homozygous condition of the abnormality, although the latter is non-viable and cannot reach mature development. Abnormalities in which the heterozygous condition alone exists, since the homozygous is non-viable, are not perhaps in the strict sense dominants, although they are usually referred to as such. Factors which can only bring about development when in the heterozygous condition are one type of the class of factors now spoken of as lethals (see p. 196). Such mutations, which are commonly spoken of as dominants in the heterozygous condition, are really defects which affect the offspring when present on only one side of the house.

CHAPTER V

THE LIMITS OF HEREDITY

ANOTHER subject of great interest in connection with human inheritance is the question of its limits. Are there any details of structure so small, or of such a nature, as to be beyond the reach of heredity? Galton considered this subject, and in his book on *Finger Prints* (1892) found such structures in the more minute details or minutiae of the individual ridges of the finger-print patterns.* We have already considered another case (p. 74) in right and left-handedness of cereals. Obviously the observation of human duplicate twins should throw much light on this subject, and since Galton's studies, in which he classified finger-tip patterns as loops, whorls, and arches, a considerable literature has grown up which

* I cannot refrain from pointing out again how closely Galton's views agreed with some of the current conceptions of continuous and discontinuous variation. He says (*l.c.*, p. 211): "Not only is it impossible to substantiate a claim for natural selection, that it is the sole agent in forming genera, but it seems, from the experience of artificial selection, that it is scarcely competent to do so by favouring mere varieties, in the sense in which I understand the term."

"My contention is that it acts by favouring small sports. Mere varieties from a common typical centre blend freely in the offspring, and the offspring of every race whose statistical characters are constant, necessarily tend, as I have often shown, to regress towards their common typical centres. Sports, on the other hand, do not blend freely; they are fresh typical centres or sub-species, which suddenly arise, we do not yet know precisely through what uncommon concurrence of circumstances, and which observations show to be strongly transmissible by inheritance."

can only be touched upon here. A full bibliography is given by Wilder (1916). The results have shown that not only the ridge patterns of the finger tips, but also those of the palms of the hands and the soles of the feet, tend to be inherited. Wilder gives some striking instances of peculiar and unusual palm and sole patterns appearing in parents and offspring. Thus, a man with a calcar loop on both feet married a woman with a calcar loop and a divergence. Of their three children, one has a loop on both feet, two have a loop on one foot and a divergence on the other, the loop being on the right foot in one case and the left in the other. Yet the calcar loop is so rare as to have been found only four times (aside from this family) in 1,000 or more individuals examined.

TWINS.

In the case of duplicate or identical twins (Wilder, 1904) these patterns show great similarity, though not identity, and there is a distinct tendency for mirror-image patterns to appear, especially on the forefingers. Light has been thrown on the subject of inheritance in twins by the studies of Newman and Patterson (1911, 1916) on development and variation in the armadillo. This animal always produces four young at a birth (some species more), and these are invariably of the same sex, and have been shown by Patterson (1913) to arise by a process of embryonic budding in the embryo derived from a single egg.

Stockard (1921) has recently suggested an explanation of this condition of polyembryony in the armadillo. The Texan species invariably produces four young at a birth, a South American species regularly produces eight, while in certain species as many as twelve young may be produced, apparently

from tertiary budding. Some other species of armadillo produce only one embryo from the egg. In the Texas species (*Tatusia novemcincta*) Patterson has shown that two buds grow out, each of which immediately divides into two. In the species in which eight young are produced, these four buds presumably divide again, while tertiary budding of the embryo produces a higher number.

Patterson (1913) found a "period of quiescence" in the development of the young blastocyst, which Newman believes to be connected with the cause of the budding. In the gastrula stage the embryo remains quiescent for several weeks. Then placentation takes place, and the development is resumed. Stockard (1921) suggests that while the blastocyst is lying free and unattached in the uterine cavity, the consequent absence of an oxygen supply (*via* the blood) inhibits development. This condition of an unattached blastocyst is found in no other mammal except the deer. It is not known why the delay in implantation of the blastocyst occurs, but from studies of other mammals it is suggested that it may be due to some peculiarity in the formation of the corpora lutea.* In other animals, for example birds, the deer, and lower animals, arrest of development does not lead to polyembryony. But Stockard finds from experiments with certain fish eggs that, if development is arrested early (before gastrulation), twins and double embryos are frequently produced. Hence the interruption must occur at a critical time. Also there must be present in the egg, as in that of the armadillo, a decided tendency to form buds under conditions of arrest. Thus it appears that the interaction of certain external and internal forces is

* A yellow mass of cells in the ovary in place of a discharged ovum. If the ovum is fertilised the corpus luteum persists and grows for several months. The number of corpora lutea therefore corresponds with the number of developing embryos.

necessary to produce polyembryony.* In the deer it is not known when the arrest occurs, but failure of budding (twins) may be due to (1) arrest being at the wrong stage of development, or (2) lack of a tendency for the embryo to bud. Possibly delayed implantation of the blastocyst, which may in turn be controlled by the condition of the corpora lutea, may account for the production of identical twins in man. A peculiarity in the activity of the corpora lutea would be as likely to be inherited as are differences in other glands of internal secretion, and such a difference would then become a factor in the inheritance of twinning.

Newman, who has investigated twinning for a number of years, published a little book on the subject (1917), and has recently (1921) taken up experiments on the production of twin embryos. He used a Californian starfish, and studied the twinning which may occur in spontaneously parthenogenetic larvæ and in hybrids with another species. He looks upon twinning as a process which involves the duplication of originally single structures. The first step involved is retarded development, followed by loss of organisation or dedifferentiation. Recovery results in the formation of new apical points, which form the anterior ends of new individuals. In the starfish *Patiria* such arrested development may result in physiological isolation of blastomeres in

* Regarding the interpretation of polyembryony in the armadillo, Professor MacBride suggests that all the South American Edentates are originally descended from tree-living animals, in which it is an advantage to have only one young at a birth, and a dome-shaped placenta as in the apes. The armadillos have taken to the ground where the risks are greater, but have not been able to recover the habit of laying more than one egg. They have, however, substituted the method of multiplication by budding from the single egg. The fact that in man also identical twins occur may similarly be a result of his arboreal ancestry.

the two- or four-cell stage, or the formation of double, triple, or multiple monsters in the blastula, gastrula, or larval (bipinnaria) stage.

It is of interest to note in this connection that polyembryony, through division of the proembryo into four cells which undergo separate development, is a common feature in the pines and in some other Abietineæ, although in *Pinus laricio* it has been observed that a single embryo sometimes develops from these four cells owing to their failure to separate. In any case only one embryo reaches maturity, the others aborting at various stages of their development. It is unknown what determines the cohesion or separation of the four proembryonic cells.

Reversed symmetry and mirror-imaging are the result of a unity in development, and the degree in which these phenomena appear in twins furnishes evidence as to the length of time which the embryos remain in contact during development. It is now generally agreed that double monsters are simply conjoined twins which have failed to complete their separation. Wilder (1916) describes a remarkable case of double twins (girls) of the extremely rare pygopagus* type. Their four palms are practically alike in ridge pattern. Three of the soles are also alike, but the fourth is radically different. Curiously enough, the data concerning the palm and sole patterns of the parents, which are necessary for an evaluation of the inheritance, are not mentioned, and this limits the interpretation of the facts. One cannot, therefore, say that the aberrant pattern is beyond hereditary control.

The famous Blazek twins, who were born in Bohemia and recently died in Chicago at the age of forty-four, are apparently another case of pygopagy. One of them was married and gave birth to a son,

* Joined by the buttocks.

now eleven years of age. Whether they were of the identical type is not stated, but they were said to differ in disposition and tastes, although they are stated to have had only one set of digestive and procreative organs. They both nursed the infant son, and food eaten by one benefited the other. As they left no wills, litigation is now pending to determine whether they should be legally considered one or two.

A similar case of united twins is described by Sullivan (1919). These twin boys were ten years old when examined, and were born in Samar Island, Philippines. They are identical twins in which the separation has been incomplete, the right buttock of one being in juncture with the left buttock of the other, and the terminal part of the alimentary canal is a single structure. They are otherwise normal and intelligent, having yellowish-brown skin colour, straight black hair and dark brown eyes. But the left twin is right-handed and the right twin left-handed. The latter also has more rounded ears closer to his head, is somewhat taller, and probably more often takes the initiative. There are marked differences in the proportions of the head and face, both being somewhat asymmetrical and laterally distorted to the right in the right twin and to the left in the left twin. Hence the distortion is probably due to external influences and developmental disturbances. The finger prints are very similar, but with minor differences in configuration.

Danforth (1919) has dissected the left hands of a pair of polydactyl negro infant twins, and compared them with a normal white infant. It is uncertain whether they were identical (uniovular) twins. The polydactylism consisted in a small, nearly globose, mass on each hand with a slender attachment to the little finger. This extra digit bore a nail and friction ridges. It is thought that polydactyly of this type

may have its greatest expression early in ontogeny, before birth, and that it may be induced either by hereditary or other factors. The twins showed marked similarity in their friction ridge patterns, also in the muscular and arterial systems of their hands, some similarity in nerve distribution, but practically no resemblance as regards the veins. Compared with the control hand, these resemblances indicate that heredity is the chief factor involved in the variations observed.

Newman and Patterson (1911) have made a study of the inheritance of peculiarities in the scutes or scales on the nine bands of the armadillo, and similar phenomena to those above mentioned (p. 179) appear in their quadruplets, but in all these cases the father is unknown. Thus, in one set of quadruplets three show a double or abnormal scute, and one lacks it; in another set three have the scapular double scute, and one lacks it. Other sets of quadruplets show more variation in the position of abnormal scutes, but the evidence indicates that the latter are, at any rate, blastogenic or predetermined in the egg. The authors attribute these divergencies to inaccuracy in the bilateral distribution of hereditary materials during development—in other words, to somatic segregation. The element of heredity cannot be accurately judged without a knowledge of the male parents. The process of scute alignment is shown to be largely mechanically determined, and hence beyond the limits of hereditary control.

Newman (1916) finds in armadillo quadruplets a condition of symmetry between that observed in double monsters (whose whole development has been in contact), and human duplicate twins. Hence he concludes that the latter become "physiologically isolated" (this may imply asymmetrical nuclear divisions of cells whose descendants remain for some

time in contact) considerably earlier in development than do armadillo quadruplets. Indeed, the amount of mirror-imaging is so small in human duplicate twins that it appears probable that the separation (actually of cells or physiologically of nuclear elements) takes place early in the cleavage, though not necessarily



FIG. 30.—TWIN AMERICAN SAILORS OF IRISH BIRTH.

at the first cleavage of the egg, as was formerly supposed. It should be pointed out that this line of reasoning, while attractive, is not necessarily conclusive according to the present state of our knowledge.

A typical case of finger-print patterns in duplicate

twins is given in the *Journal of Heredity*, November, 1916 (see Figs. 30, 31). The patterns are alike in these two men, except that the thumb of the left hand has a loop in one twin and a whorl in the other, while the middle finger in the former has an arch, and in the latter a loop. Moreover, in each twin the patterns on the fingers of the left hand are in nearly every case mirror-images of the patterns on the corresponding

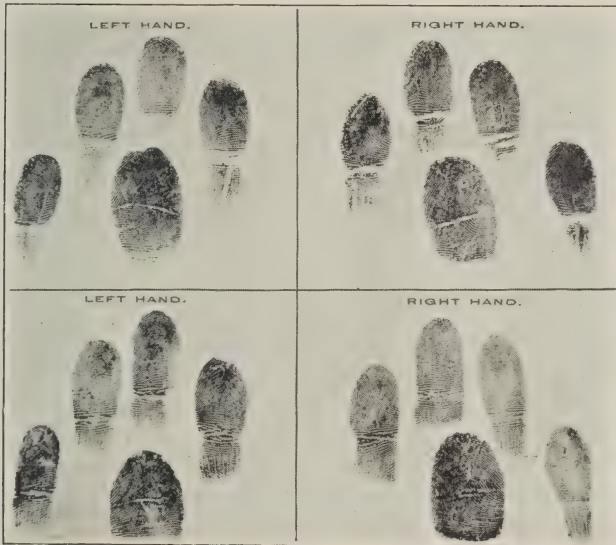

FIG. 31.—FINGER PRINTS OF THE TWINS IN FIG. 30.

The thumbs of their left hands and the middle fingers of their right hands are clearly distinguishable in pattern.

fingers of the right hand. Another evidence that these friction-skin patterns are on the borders of hereditary control is found in the fact that in a congenitally split finger observed by Wilder the patterns of the two finger tips were not identical. In all hands the minutiae of the ridges, such as forkings, interruptions, and isolations, remain constant throughout life, and these form the basis for the identification

systems. These details are clearly not inherited, for no two patterns are alike in these particulars, and Galton concluded that the chance of two finger prints being identical was less than 1 in 64,000,000,000.

The inheritance of finger-print patterns is the subject of a paper by Miss Elderton (1920). The arch, loop, whorl, and composite are the types of pattern used for criminal classification. But this is inadequate for scientific distinctions. Galton increased his four or five original categories up to fifty-three. He was led to assume continuity between

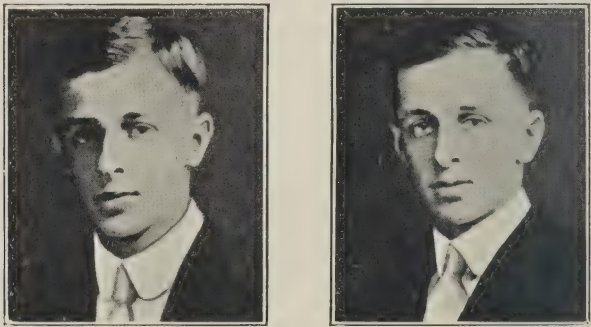

FIG. 32.—TWINS, EIGHTEEN YEARS OF AGE, FROM YORK, PENNSYLVANIA.

types, and for years sought quantitative measures for the finger print. Miss Elderton adopts the following order, arch, small loop, large loop, composite, whorl, as a natural order in passing from type to type. An effort was made to state the inheritance in Mendelian terms. The difficulties were (1) in the presence of transitional forms; (2) there is probable inheritance of pattern with change of finger. Assuming that inheritance was on the same finger from parent to offspring, and classifying Galton's data, she found that: (1) Arch \times arch and arch \times composite appear to give no whorls; (2) whorl \times whorl and whorl

× composite give no arches; (3) arch × loop, whorl × loop, composite × loop, and loop × loop can give all four types; (4) composite is rare, but it may be that composite × composite cannot give arches; (5) arch × whorl can give all types. These results suggest that loop is "much more heterozygous" than arch or whorl. If composite is combined with loop, simpler ratios are obtained. But the Mendelian

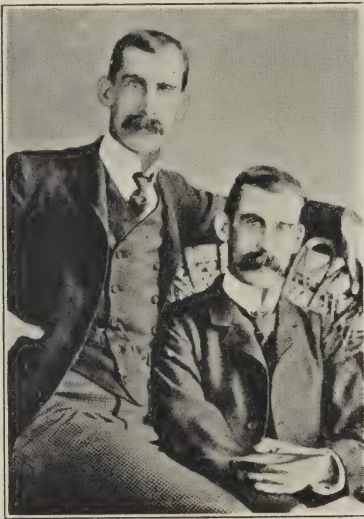

FIG. 33.—TWINS HAVING THE SAME HEIGHT, WEIGHT, TASTES, DISPOSITION, AND TALENTS.

They have worked together for twenty-five years and have never been separated.

interpretation is unsatisfactory (1) because it is unjustifiable to combine composite with loops; (2) because the categories are really not sharp, but a great variety of transitional forms occurs; and (3) there is good reason to believe that inheritance is not necessarily from one finger of the parent to the same finger of the child. The coefficient of inheritance method of treatment gives low values of inheritance.

The brain convolutions in duplicate twins have also been compared. For example, Sano (1916) studied the brains of stillborn twin boys. One boy



FIG. 34.—TWINS FROM BATTLE CREEK, MICHIGAN.

They were separated when three years of age, and have always lived apart. Even their best friends cannot distinguish them when they meet.

was somewhat larger throughout than the other, and this applied also to the brains, the larger brain being more highly developed, with more sulci. But



FIG. 35.—TWIN SISTERS FROM ROMANSHORN, SWITZERLAND.

there was a very remarkable similarity in the disposition of the furrows, and all the differences were of secondary importance, thus indicating the inheritance of similar mentalities.

Galton (1883) made a study of twins, which contains many facts of great interest. In response to inquiries he obtained descriptions of about eighty pairs of closely similar twins, thirty-five of which entered into full details. He says (p. 216): "In a few of these not a single point of difference could be specified. In the remainder the colour of the hair and eyes was almost always identical; the height, weight, and strength were nearly so. Nevertheless, I have a few cases of a notable difference in height, weight, and strength, although the resemblance was otherwise very near. The manner and personal address of thirty-five pairs of twins are usually described as very similar, but accompanied by a slight difference of expression, familiar to near relatives, though unperceived by strangers. The intonation of the voice when speaking is commonly the same, but it frequently happens that the twins sing in different keys. Most singularly, the one point in which similarity is rare is the handwriting. I cannot account for this, considering how strongly handwriting runs in families, but I am sure of the fact. I have only one case in which nobody, not even the twins themselves, could distinguish their own notes of lectures, etc., barely two or three in which the handwriting was undistinguishable by others, and only a few in which it was described as closely alike. On the other hand, I have many in which it is stated to be unlike, and some in which it is alluded to as the only point of difference. It would appear that the handwriting is a very delicate test of difference of organisation—a conclusion which I commend to the notice of enthusiasts in the art of discovering character by handwriting."*

Galton cites a number of remarkable similarities in these thirty-five pairs of twins and others. In

* Cf. p. 172.

seven of the thirty-five, both twins "suffered from some special ailment or had some exceptional peculiarity. Two twins at the age of twenty-three were attacked by toothache, and the same teeth had to be extracted in each case." A pair of French twins who travelled as business men and were asthmatic always had attacks in the same cities. They were taken simultaneously with rheumatic ophthalmia (an inflammation of the eye), one in Paris, and the other in Vienna. In another French case the twins were monomaniacs, melancholy, morose, suffering from imaginary persecutions, etc. They showed precisely the same symptoms, although always kept apart and never communicating with each other. At intervals of months the same mental changes would spontaneously come over them both independently, even when they were in institutions some miles apart.

In eleven of the thirty-five pairs of twins cited by Galton there was the same association of ideas, twins often making the same remarks on the same occasion, or beginning to sing the same song at the same time. One twin visiting Scotland bought a set of champagne glasses as a surprise for his brother B. The brother in England at the same time bought a set of precisely the same pattern for his brother A. In sixteen cases the twins were closely similar in tastes and dispositions. The differences in the others were merely in intensity or energy, one being more vigorous, the other more gentle, etc. The mental similarities evidently extended to the fundamental structure of the mind, and were not merely superficial. In only two cases was a strong bodily resemblance accompanied by mental diversity, and the converse occurred only once. Clearly a more extended study of the mental differences between identical twins will throw valuable light on questions of mental inheritance.

The records of similar twins show that illnesses clearly retard growth, and may thus cause permanent differences between twins. Some inherited differences also first develop late in life.

The number of the *Journal of Heredity* for December, 1919, is devoted entirely to twins, and contains thirty figures, chiefly photographs of twins, which show remarkable degrees of resemblance. One pair of grown-up brothers have not only identical features, but the same height and weight, the same tastes, disposition, and talent. Another pair of identical twins of exceptional ability have never differed more than a pound in weight, never varied more than 0.1 per cent. in their college marks, and although absolutely dependent upon glasses, can wear each other's. Their illnesses have often coincided, and most of their tastes are similar. But their tailor says that one of the twins has a short left arm and the other a short right arm—a mirror-image difference such as frequently occurs in twins. Several pairs of these twins are illustrated in Figs. 30 to 35.

The record of identity in another case extends to size, voice, and tastes in music, but they differ in their taste for mathematics. Twins which were separated at three years of age (Fig. 34), and have since remained apart, show an equally striking identity of features. The handwriting, which is known to be an index of character, is closely alike in many twins, in one case "virtually identical," but differences are also recorded.

There are clearly differences in the degree of resemblance between "identical" twins. One pair of men twins agree in features and in their likes and dislikes, diversions, foods, and intellectual interests. They both suffer from night-blindness, but their handwriting is "very different." Another pair have similar tastes for poetry and music, and enjoy the

same sports, but differ in their mathematical tastes and in their gait. One was left-handed as a child, but their writing is strikingly alike, and they both have the same peculiarity of the left thumb joint. They differ in application and in nervousness. This is a striking combination of similarities with minor differences and an unaccountable left-handedness in one.

Still another pair of men of fifty-nine show less identity of feature, but similar gait and bodily weaknesses, the same dislike for strawberries and acid foods, and a congeniality for each other which appears to be characteristic of identical twins. But their ocular defects pertain to the right eye in one and the left eye in the other, and their handwriting is not strikingly similar, though showing marked resemblances.

Popenoe (1922) has recently described a case in which twin girls were reared separately and have led very different lives yet maintain their physical and mental identity. The mother died, and they were separated at the age of eight months. They did not see each other again or correspond until they were eighteen, and have only been together for about ten months in all their lives. One married and taught in a school, the other travelled and has followed a business career in various parts of the country. Yet they remain of exactly the same height and can wear each other's clothes. Their hair and voices are the same and people cannot tell them apart. They even both had their hair bobbed at the same time, each without the other knowing it. Their intellectual capacities appear to be very similar, as well as their tastes. Like many twins, their illnesses also usually came at the same time. Here is an excellent example showing the overpowering importance of nature, and the insignificance of environment and experience in producing differences.

One of the interesting facts concerning "identical" twins which emerges, and has already been shown in other data, is (1) that they differ in their degree of resemblance; (2) that they may show exceptional similarity in most respects, and marked divergence in a few. The former fact can probably be accounted for, as explained above, on the basis of an earlier or later separation of blastomeres, or of the budding rudiments of separate embryos. Marked divergence in certain characters was also obtained in armadillo quadruplets, together with mirror-image effects. The explanation is doubtless the same in both cases, but is not clear at the present time, unless it be that they are biovular twins from parents heterozygous only in these characters. A certain amount of divergence must be expected even between identical twins, just as the two sides of the face, or the measurements of any bilaterally symmetrical organs of the body may show differences. It is a more puzzling fact that this bilateral asymmetry is itself inherited, as shown by identical twins whose faces show exactly the same asymmetries (Fig. 34).

A fact in this connection which is frequently forgotten is that the only reason why human identical or monozygotic twins more closely resemble each other than ordinary brothers and sisters is because man is usually heterozygous for so many characters that the chances of two different germ-cells from the same parents furnishing exactly the same combination of characters is remote. Nevertheless, it is undoubtedly the fact that in some families in which both parents are homozygous for many characters, brothers or sisters may, and do, occasionally occur from separate births, and yet resemble each other as much as identical twins, except that there is always an age difference. Biovular twin births in such families may be expected to give rise occasionally to twins

which appear to be of the "identical" type, except in one or two, or a few characters in which the parents were heterozygous and the germ cells concerned happened to carry the corresponding allelomorphous characters.

We are so accustomed to seeing diversity in the offspring from a single pair of human parents that we forget what always happens in crosses of homozygous types. Any plant breeder will have made numerous crosses in which the F_1 offspring are so absolutely alike as to be indistinguishable by any visible differences, or probably even any constant measurable difference. There is no doubt that, for similar reasons, what appear to be identical or monozygotic twins occasionally appear in human families when they are really dizygotic or ordinary twins of the same sex. This clearly helps to account for the occurrence of intermediates between identical and fraternal twins—*i.e.*, twins of the same sex which differ only in a very few characters.

Windle (1892) has collected numerous cases of identical malformations in twins, many of which were known to be of the identical type, although, unfortunately, the sex is specifically mentioned in only one or two. A case is described of twins enclosed in the same membranes, in both of which there was a deficiency of the anterior abdominal wall, the intestines and part of the liver being contained in a thin membranous sac. Another sac, the size of a walnut, hung posteriorly from between the thighs. The latter was probably due to persistence of the neurenteric canal, dilated by the rachidian fluid to form a sac. Instances in which both twins have the same malformation are said to be not uncommon. But in Rotunda Hospital, Dublin, in the years 1847-1854, there were 13,748 women delivered, of whom 233 had twins (=1 in 59), none, however, showing similar

malformations. Windle cites numerous instances from the literature, including two cases of twins, both showing hypospadias; (3) one pair with hermaphroditismus masculinus; (4) one with occipital meningoceles* of the same size, and hypospadias as well; (5) one of spina bifida;† (6) occipital meningocele with the upper and low extremities one-quarter their normal length (considered phocomelia‡); (7) anencephali (without a brain), the palates, also having a deep longitudinal furrow; (8) male twins, both with right-sided congenital hydrocele;§ (9) twins with cyclopia (one median eye); (10) twin girls with abnormally developed sex organs, christened as boys; (11) twins with six digits on hands and feet (in one amnion); (12) twins with a supernumerary pollex (thumb) on the right hand; (13) one twin with six fingers, the other with six fingers and six toes; (14) twins with a sternalis muscle, the mother also having one; (15) twins with a remarkable conformation of the left parietal bone; (16) cited by Galton, a pair of twins with slight congenital flexure of one of the joints of the little finger. The condition was inherited from a grandmother, but neither parents nor sisters nor brothers show any trace of it. (17) Twins with a peculiar way of bending their fingers. There is a faint tendency to the same peculiarity in the mother, but in no other member of the family. (18) Cited by Darwin, twins with a crooked little finger, but no known family tendency to this peculiarity.

* Hernial protrusion in the occipital region of the three membranes surrounding the spinal cord.

† Congenital cleft of the vertebral column.

‡ A condition with hands and feet, but no arms or legs.

§ A collection of fluid, occurring especially in the scrotum.

INHERITANCE OF TWINNING.

Interesting studies have recently been made on the inheritance of twinning. It is well known that a tendency to produce twins is inherited in sheep, certain breeds nearly always bearing twins. Davenport (1920) places the frequency of twin births at about 11 per cent., and Bonnevie (1919*b*) finds, from statistics of human births in Norway, that 1.34 per cent. of births are twins. In one Norwegian family, however, the frequency of twin births was as high as 19.5 per cent., showing a strong tendency to inheritance. It is significant that twinning occurs more often in large than in small families. In the families investigated, 20 per cent. of the twin births were believed to be uniovular—*i.e.*, derived from a single impregnated egg. It is suggested that the tendency to produce biovular or non-identical twins is a recessive character, but this conclusion does not appear very probable.

In a statistical study of twinning in families, Davenport (1920) considers families in which twin births had occurred more than once. The mothers and fathers of such families are spoken of as repeaters. If inheritance of twinning were only through the mother, then the relatives of repeating mothers should show a higher proportion of twins than the relatives of repeating fathers. It was found, however, that of 355 labours occurring to the mothers of repeating mothers, 16 or 4.5 per cent. were twin labours; while of 289 labours occurring to the mothers of twin-repeating fathers, 12 or 4.2 per cent. produced twins. Thus, twins occur with nearly equal frequency in the fraternities of repeating fathers and mothers, and with about four times their frequency in the general population. These and similar statistics indicate that, in strains bearing two or more pairs of twins to a family,

the hereditary influence of the father on twin production is approximately equal to that of the mother. In thirty families containing twins classed as identical, both the fathers and the mothers belonged to fraternities in which there were 13 per cent. twin births. Hence the inheritance factor in the production of identical twins is nearly three times as strong as in the production of twins in general, and again the influence of the father appears to be as great as that of the mother.

The sex of twins is also used as a means of determining how many are probably biovular or uniovular in origin. In 160 pairs of twins in repeater families (having two or more pairs of twins), in which the sex was given, fifty-four were of unlike sex and 106 of like sex. Since the expectation for two-egg twins is an equality of like and unlike sexed twins, the excess of fifty-two pairs of like-sexed twins was probably uniovular in origin. This indicated that about 1 in 3 of the twin births are of identical twins. Davenport has also examined families in which one parent of twins has married twice. In fourteen cases the father married twice, in fifteen the mother, and in one family both father and mother. Where the father had married twice, there were twins of both marriages in two cases, or 14 per cent., and the corresponding figure where the mother had remarried was 21 per cent., again indicating by these high values the hereditary nature of twinning.

Until recently it would have appeared absurd that the father could have any hereditary influence on twinning, but Davenport points out how our present knowledge provides the basis for such a result, at least as regards biovular or fraternal twins. In the first place, there is evidence to show that the simultaneous release of two eggs is much more frequent than are twin births. There is statistical evidence from the

examination of corpora lutea (see p. 177) that 5 to 6 per cent. of ovulations are probably double. When the number of corpora lutea of pregnant rabbits and pigs is compared with the number of embryos, there is found to be always an excess of the former, indicating that some eggs fail to be fertilised after ovulation. Blighted embryos are also repeatedly found. They account for some of the human cases of early miscarriages. Such cases are by no means always due to physiological causes, but are often to be explained by inability of the embryo to complete its development. Lethal factors which kill the embryo or inhibit its development beyond a certain point when present in homozygous condition are now well known through the work of Morgan and his pupils with the fruit fly *Drosophila*. It has long been known that only mice heterozygous for yellow body colour can live, and it has recently been shown that when such yellow mice are crossed with each other, 25 per cent. of the embryos—*i.e.*, the homozygous yellows—are atretic and fail to develop.

Such evidence makes it certain that double ovulations are much more frequent than twin births. This will be due, as Davenport points out, to (1) a failure of fertilisation of one egg, or (2) a failure of development of one egg. Of course, lethal factors may be present in both egg and sperm, and their presence will probably account for many cases of sterility in mankind. Thus a woman may be sterile with one husband and fertile with another, or a man may have children by one wife and not by another. Couples desiring children not infrequently fail to produce them. In some of these cases the germ cells of both may contain the same lethal factor, or a combination of factors which are incompatible with development. It is well known that dairy cattle show similar phenomena, a particular bull being sterile with

certain cows. Gynecological literature abounds with cases of blighted twins, or of single births accompanied by an undeveloped fœtus. Probably the presence of lethal factors in some of the germ cells accounts for many such cases. We have already seen (p. 90) that brachydactyly is perhaps lethal in its effects when present in the homozygous condition, and the same is probably true of various other abnormalities. The conception of lethal factors is thus destined to play an important part in the explanation of many phenomena of reproduction in man, and to furnish an explanation of sterility in some cases where there has been no voluntary prevention of children.

A remarkable instance of a strain producing multiple births has recently been described (Davenport, 1919). A woman living in Cleveland, Ohio, has in three successive marriages never had a single child at a birth. She was born in Paris, and her mother and her mother's mother are both said to have had only twins, triplets, or quadruplets. By her first husband she had twins. When he died she married a French-Canadian, and bore twins, a boy and a girl. The girl married and bore first a single child, and then twins, who died with the mother shortly after birth. The original mother next bore triplets ♀ ♀ ♂ who died young. Two years later twins ♀ ♂ were born, and again the following year twins ♀ ♂. By a third husband of English and Scotch descent she had twins ♂ ♂, who died young, then triplets ♂ ♀ ♀, a boy still living and two others born dead. This was followed by a miscarriage of triplets ♀ ♀ ♀, then twins ♀ ♂, the girl dying shortly after birth. Next followed a miscarriage of quadruplets ♂ ♂ ♀ ♀, caused by poor health of the mother. Twins ♂ ♀ followed, the girl dying in ten days, then triplets were born ♂ ♀ ♀, the boy surviving. In 1912 quadruplets, girls, were born; the

same year occurred a miscarriage of four boys, and the following year a miscarriage of three girls. This makes a total of forty-two births and miscarriages from the one mother. In this remarkable case the tendency to multiple births has been traced in four generations.

Hayden (1922) describes a case of a pure-bred Holstein-Friesian cow in the herd of the Ohio Agricultural Experiment Station which has had twin calves five times out of seven by three different bulls. A more remarkable case is described by Pearl (1912), who remarks that: "It is well established that a tendency to multiple gestation in normally uniparous forms may be inherited." A Guernsey cow produced fourteen calves in her first eight pregnancies, bearing triplets twice, twins twice, and single young four times. The triplets were two females and a male, the former probably free-martins. The male closely resembled the mother, while the females were of different colour and pattern like the father.

That there are two types of twins—identical or uniovular, of the same sex, and showing exceptionally close resemblance; and biovular or fraternal, showing no greater resemblance than ordinary brothers and sisters—has, of course, long been recognised. Occasionally attempts have been made to show that twins do not fall into such categories, but without success. Fisher (1919), from a mathematical treatment of some early data of Thorndike, thinks it necessary to conclude that differences in the degree of resemblance between twins could be accounted for by assuming that the egg divides into two halves, each of which is fertilised by a different spermatozoon. Such an hypothesis seems to have no biological or experimental evidence in its favour, while the evidence for the existence of both biovular

and uniovular twins in mankind is strong and unequivocal.*

It was formerly supposed that identical twins were produced by separation of the first two cells formed by the division of the fertilised egg, the first two cells into which the egg divides becoming separated after the egg has been fertilised by a single sperm. There is experimental evidence of the production of two embryos or of double monsters from invertebrate eggs by this method. But since the investigations of Newman and Patterson on the armadillo, in which the latter showed that the four embryos at a birth are produced by budding at an early stage of development, it has seemed much more probable that identical twins (surrounded by a common chorion) in man are produced in a similar way. Moreover, the number of buds in the nine-banded armadillo is occasionally three or five, and varies more widely in other species; and probably in man also the number is not absolutely fixed, but may occasionally be three, thus accounting for some cases of triplets of the same sex.

Zeleny (1921) finds a definite relation between the number of twin births and triplet births in mankind.

Thus, if $\frac{I}{n}$ is the number of twin births, then the number of triplet births will very nearly approximate

$\frac{I}{n^2}$. In Prussia during the years 1826-49 the

* A recent case (Arey, 1921) proves directly the origin of identical twins from a single ovum. Twin embryos are described, each 12.3 mm. long, and contained in a single amnion and chorion. The two umbilical cords and yolk-stalks were inserted in a common yolk-sac. In a second pair of monochorionic twin embryos with separate amnions, one of the embryos had neither yolk-stalk nor sac. It is suggested that the human embryo probably shows rather rigid determinate cleavage, and that monozygotic or identical twins result not from the separation of blastomeres or blastomere clusters in early cleavage, but "from later fission of the inner cell mass."

number of births was 13,360,557. The frequency of twin births was 1 in 89.1, and of triplets 1 in (88.9)². For quadruplets, however, there is an excess over expectation, the number being 1 in (71.9)³. Again, in the United States birth-registration area in 1917 the number of births is recorded as 1,339,975, the number of twins being 1 in 93.1, and of triplets 1 in (93.0)². From these statistical relations it would follow that " triplets are produced by the coincidence of two independent processes occurring with equal frequencies." One of these processes gives rise to twins. This relation would hold whether multiple births occurred through multiple ovulation or budding of a monozygotic embryo or both, provided that each followed the rule. This result is remarkable when one considers the number of conditions, both biological and human, which contribute to produce the registration statistics.

Man appears to be unique among animals, as Davenport points out, in that he produces both types of multiple births: (1) by the budding method found in the armadillo; (2) multiple births from separate eggs, as found in carnivora, herbivora, and rodentia generally. Differences in the degree of resemblance between identical twins may depend in part on the stage at which budding of the original embryo takes place. Much more information is required regarding human multiple births, particularly data from obstetricians on such matters as the number of chorions present, the presence of blighted embryos in the afterbirth, and the relation between the number of corpora lutea and the number of embryos at a birth. The study of twins presents many sides, and will furnish evidence on a variety of questions connected with heredity and reproduction in the human race.

The recent study of the so-called free-martin or

sterile female in cattle has thrown a good deal of light on questions of sex alteration, and also on the production of twins in cattle. John Hunter (1779), in an early account of the free-martin, states that it was a type well recognised by the farmers at that time. Such barren cows in Roman times were called *tauræ*, but apparently the Romans did not understand the manner of their production. Hunter says: "It is a known fact, and, I believe, is understood to be universal, that when a cow brings forth two calves, and that one of them is a bull-calf, and the other a cow to appearance, the cow-calf is unfit for propagation; but the bull-calf becomes a very proper bull." This clearly states the general facts regarding the production of free-martins. Hunter dissected three such animals and considered them hermaphrodites, but found that they differed from one another. He gives the anatomical details of his dissections, and states that free-martins are "much larger than either the bull or the cow, and the horns grow longer, being very similar to the horns of an ox."

The important investigations of Lillie (1917) on the fetal development of twins in cattle has furnished a clear explanation of the fact that the free-martin is nearly always sterile. The internal reproductive organs of the free-martin are found to be usually predominantly male, while the external organs are at least usually female, but there are considerable variations. Lillie's main discovery was that in the production of twin embryo cattle there is a secondary fusion of the two chorions and anastomosis of the circulation of the two fetuses. The free-martin is a female transformed by the action of hormones derived from the male twin, which pass through the anastomosed bloodvessels into the circulation of the female embryo. Nearly all twins of cattle are monochorial, with the chorions more or less completely fused.

About 13 per cent. of free-martins (*i.e.*, females twinned with a male calf) are fertile. This happens when the fusion of chorions does not take place, and there is hence no opportunity for the male embryo to influence the development of the female. It is also found that there are always in cattle two corpora lutea present when twins are born, and a single one at single births. This shows that the vast majority, at least, of twins in cattle are derived from two separate eggs. There is no certain evidence that monozygotic twins ever occur in cattle. This is contrary to the condition in man, where both monozygotic (identical) and dizygotic (fraternal) twins are now known to occur.

That monozygotic twins occur but rarely, if at all, in cattle and sheep, is shown by the ratio of the sexes in twin births. This ratio closely approximates $1 \text{ ♂ } \text{♂} : 2 \text{ ♀ } \text{♂} : 1 \text{ ♀ } \text{♀}$, which would occur if all twins were derived from separate ova. The data on this subject have been considered by Gowen (1922). In human twin births there is a wide departure from this ratio, owing to the occurrence of "identical" twins derived from a single ovum. Thus, in statistical records of Nichols, the proportions of the sexes in human twin births is males, 234,497; male and female, 264,098; females, 219,312. This represents a ratio of $1.07 : 1.20 : 1$. These statistics are clearly in harmony with the view that both uniovular and biovular twins occur in man.

Gowen has also compared the colour markings of cattle twins, taken from the Herd Books of the American Jersey Cattle Association. These records included 749 twin females, 168 twin males, and 207 male and female. Compared as regards colour markings, tongue colour, and switch colour, there was found to be little if any significantly greater resemblance in favour of twins of like sex. There was, however, 5 per cent. greater resemblance in favour of male

twins as compared with twins which are male and female, and this might be due to the occurrence of monozygotic twins. But in no case is this difference greater than twice the probable error, so it really furnishes no evidence in favour of the occurrence of monozygotic twins in cattle.

Lush (1922) describes a pair of twin Jersey heifers which he thinks are identical. They both have a moderate notch (see p. 135) in their ears; their noses, tongues, switches, and general shade of body colour are the same; and they each have a single spot on the right hind foot. This indicates that monozygotic twins occasionally occur in cattle. It is hardly likely that both parents would be homozygous for all these characters.

In pigeons, two pairs of female monozygotic twins have been described (Riddle, 1918). They were both derived from eggs with very large yolks, but not "double-yolked," the embryos having a single yolk sac. It is believed that they were formed by the separation of the first two blastomeres in the fertilised egg, this separation being a result of the very large initial size of the egg.

203
175
—
28

CHAPTER VI
SOCIAL AND WORLD ASPECTS OF
EUGENICS

WHILE the observation and study of the innumerable alternative differences in man is a theme of great interest, yet it lies for the most part outside the range of practical eugenics, for great numbers of these differences, aside from abnormalities, are, as far as our present knowledge goes, innocuous in nature, being neither advantageous nor detrimental in their effects, but lending a pleasing and desirable variety to the human race. \ The aim of practical eugenists would, then, be rather so to direct selection by controlling the conditions which determine selection as to eliminate the obviously undesirable or anti-social traits; and to improve, through public opinion or otherwise, the chances of perpetuation and increase of their kind on the part of the better qualified members in every stratum of society. This aim, though easily stated, is obviously almost infinitely difficult of achievement in a complex civilisation. And it is rendered all the more difficult by the fact that eugenics aims, not to establish and improve a single type, as in breeding, for example, racehorses, but at the infinitely more complex result of improving innumerable more or less inter-breeding strains simultaneously, weeding out their more defective members or qualities, and at the same time maintaining the diversity of types in the whole population. A world of Shakespeares or Newtons or Goliaths, even if attainable, would not be an economic success.

Differentiation of types is one measure of civilisation, and no high type of culture could long be maintained without it. The miner and the professor, the peasant and the banker, each in his sphere makes his contribution to civilisation, and so widens its boundaries and increases the richness (mentally and morally, as well as economically) of the social inheritance of tradition which makes the maintenance of culture possible and the development of culture cumulative.

Nevertheless, there is great need for improvement in the general mental and physical level of our race through some form of selection. Probably no race has ever rivalled the Greeks in the number of great men they produced in a relatively small population during a period of a few centuries. It should be possible to devise some more effective means of discovering the youths of exceptional quality in every stratum of society, and giving them larger opportunities of self-expression. Mere advocacy of an indiscriminately higher birth-rate, fostered by artificial doles to the poorer classes of society, will only achieve a dysgenic result. An able discussion of these problems is to be found in Bateson's presidential address to the British Association in Sydney, Australia, 1914.

The presence of various pairs of alternative characters in the same individual probably has the same stimulating effect in man that it has been experimentally shown to have in such organisms as maize and wheat. The frequently increased vigour of hybrids was known to Darwin and other early writers, but modern genetic experiments have given the facts a much more precise orientation, although its cause cannot yet be said to be fully understood. The phenomenal growth of certain hybrid walnuts, and the remarkable hardiness and vigour of such hybrid trees as the London plane, are well known.

But, on the other hand, inbreeding by no means necessarily leads to deterioration. Among plants, garden beans (*Phaseolus vulgaris*) and the small-flowered evening primroses (of which there are many species) are regularly self-pollinated, and probably are crossed only at long intervals under exceptional circumstances. Yet they are not lacking in vigour, and, indeed, the small-flowered *Oenotheras* are much more widespread in their wild condition in North America than the large-flowered forms which are open-pollinated, and hence give greater chances for crossing. The former have been more successful in an evolutionary way, despite their self-pollination. The advantages of ensured seed production for every flower have more than counterbalanced any advantages derived from crossing.

In this connection it is necessary to remember several points. First, the hybrid vigour or heterosis arising from crossing both in plants and in animals is confined very largely, or in some cases entirely, to the first hybrid generation. It is therefore a purely temporary phenomenon, unless the crossing is continued in each generation. It is apparently not even a constant accompaniment of the heterozygous condition, but is specially characteristic of the F_1 generation. Another point to remember is that inbreeding, which must always occur to some extent even amongst wild animal species, tends to reduce the amount of heterozygosity in each generation. Probably in man, in whom a host of character-differences are being redistributed in each generation, a homozygous condition is seldom reached, except as regards a relatively small number of characters. The degree to which the homozygous condition exists in any family may be to some extent measured by the amount of diversity between sibs (brothers and sisters) and their parents, grandparents, and collateral

relations. Obviously, if they all resemble each other in a particular character, the family will be homozygous for that character. But it appears that in modern civilised races, at any rate, this is seldom the case, even for a single character. Nevertheless, many Scandinavian families are probably homozygous for blue eyes, and other similar cases might be mentioned, but they are obviously exceptional. This brings us to consider briefly some of the mathematical laws connected with in-breeding and cross-breeding.

A considerable mathematics has grown up about the study of Mendelian characters. It is not my purpose to deal with that literature here, but a few of the consequences of Mendelian inheritance as regards the whole population may be pointed out. There is considerable evidence that many trivial characters in plants and animals, as well as in man, are quite innocuous as regards the welfare of the organism, at least under usual conditions. It is difficult to believe that a long nose or blue eyes is of any direct biological advantage to their possessor in a civilised community in temperate countries. But under a burning sun in a condition of nature it is at least highly probable that a pigmented iris as well as a pigmented skin are a distinct protection. This is, perhaps, why such mutations in loss of pigmentation as have occurred to native races in the tropics, have never been able to establish themselves or give rise to a distinct type.

While natural selection as regards blue or brown eye colour is therefore probably inoperative in temperate countries,* it might easily become operative under wild conditions in the tropics. Warren (1917), in a paper on the numerical effects of natural selection acting upon Mendelian characters, shows the number of generations which would be required

* What sexual selection may do is another matter.

to eliminate a dominant or a recessive character. He finds that in a Mendelian population in which the numbers tend to double in each generation, and in which a dominant character has twice the viability of the corresponding recessive, then the recessive will be eliminated in the eleventh generation. On the other hand, if the recessive is twice as viable as the dominant, then the latter will be eliminated in eight generations. Hence, other things being equal, the elimination of a deleterious dominant character is more rapid than of a recessive.

The subject of the Mendelian proportions in a mixed population was first considered by Pearson (1904). He showed that with random mating of two forms AA and aa and their progeny, the formula $AA+2Aa+2aa$ will apply to the proportions in every later generation—*i.e.*, the population will remain stable. Hardy (1908) pointed out the same thing. Pearl (1913, 1914) has worked out formulæ for different types of inbreeding, and determined coefficients for different degrees of relationship among inbred pedigrees. Jennings (1916) has elaborated eighty-two formulæ, from which can be calculated, in many cases directly, the results of various systems of breeding in a Mendelian population. The results vary, of course, not only according to the system of breeding followed, but also according to the composition of the population at the beginning. The systems of breeding analysed include random mating, assortative mating, self-fertilisation, and various systems of inbreeding, and from the formulæ obtained the relative proportions of the various types in any generation may be determined.

With random mating the resulting population generally remains stable, but with inbreeding or assortative mating it may alter progressively in a given direction. Inbreeding will also, of course, gradually

transform any heterozygous population into a homozygous one, the rapidity with which the completely homozygous condition is reached depending on the system of inbreeding employed and the degree of heterozygosity in the original population. Self-fertilisation, which is not uncommon in plants, is, of course, the most stringent form of inbreeding, and it quickly reduces any heterogeneous heterozygous population to a completely homozygous (but heterogeneous) condition, unless some condition in the germ plasm, such as balanced lethal factors, or some method of reproduction, such as apogamy, prevents the gametic representatives of the different characters being freely redistributed to the next generation. In wild species, also, some of the Mendelian characters in the population may be subject to natural selection, positively or negatively, and thus alter their proportions in the population. This would lead to the elimination of certain characters, even in a population mating at random, although such characters are more difficult to eliminate from the germ plasm when recessive than when dominant. In the same way the action of natural selection would lead to the more rapid multiplication and spread in the population of a favoured character whether dominant or recessive.

Laughlin (1920) has worked out the conditions of ancestral inheritance in man, assuming twelve pairs of chromosomes representing as many pairs of linked genes. Galton's original law of ancestral inheritance is well known—namely, that the two parents contribute 50 per cent. (0.5) of the inheritance, the four grandparents 25 per cent. or $(0.5)^2$, the eight great-grandparents 12.5 per cent. $(0.5)^3$, etc., the total heritage being $(0.5) + (0.5)^2 + (0.5)^3 + \dots = 1$. Karl Pearson later modified this scheme, on the basis of statistical data of correlation between father and son, finding that the resemblance varied from 30 per

cent. or more for some characters to 50 per cent. or more for others. Laughlin's scheme is based upon the known constitution of the germ plasm—*i.e.*, its division into chromosomes, each bearing its group of genes; and ancestral influence is measured by tracing individual chromosomes backwards through previous generations. The "trail" of a given chromosome in the ascendant or descendant generations will depend upon the laws of probability and recombination, and these laws will differ for the ordinary chromosomes and the X and Y chromosomes. On this basis various mathematical formulæ are developed for calculating ancestral influence.

THE BASIS OF RACIAL AND TEMPERAMENTAL DIFFERENCES.

In discussing questions of elimination or increase of certain types or characters, it is very desirable to know not only what relation these characters bear to the economy of the organism, but also what are their sources and controls in its development. The ductless or endocrine glands, which have been studied in recent years, are of the utmost importance in this connection. They pour directly into the blood in minute quantities hormones which influence and control directly the activities of various organs of the body. They also form a system of checks and counterchecks to each other, and so constitute a sort of interlocking directorate, exercising the most complete control over the bodily activities, as a whole, through the medium of the substances they discharge in minute traces into the blood. These glands have a very long evolutionary history, being derived from totally different organs having other functions, which are present in the lower vertebrates (Chordates) such as *Amphioxus*.

In his presidential address to the Anthropological

Section of the British Association, Sir Arthur Keith (1920) discusses the basis of differentiation of mankind into racial types, and shows how the characteristic racial differences are probably connected with differences in the secretions of the endocrine glands. He points out that the characteristic differences of feature, build, and colour cannot (for the most part) have been evolved directly by natural selection of variations, and elaborates the view that the differences observed are a result of variations which have arisen in the organs of internal secretion. These glands are now known to control in a marvellous manner the processes of development and functioning of the body. The principal of these organs are as follows: (1) The thyroid (a gland in the neck, astride the trachea); (2) the parathyroids (four small glands close to the thyroids); (3) the pituitary (a small reddish organ at the base of the skull), of which the anterior and posterior lobes have different functions; (4) the pineal body;* (5) the suprarenal capsules, over the kidneys, consisting of cortex and medulla, with different origins and diverse functions; (6) the islets of Langerhans in the pancreas; (7) the interstitial tissue of the gonads. These glands pour directly into the blood which bathes them extremely minute quantities of their various secretions, and the latter control in remarkable fashion both the development and functioning, not only of the body, but also to some extent of the brain and mind.

The first instance in which the form of the body was found to be influenced by an internal secretion was that in which a pathological condition of the pituitary was shown to be the cause of the condition, known as acromegaly, in which there is enlargement of the bones and flesh of the hands, feet, and face.

* A small gland, about the size of a pea, under the brain, resting on the anterior corpora quadrigemina.

Enlargement of the pituitary is also frequently associated with gigantism. Dwarfism may result from an invasion of the pituitary by tumours, and also from a failure of functioning on the part of the thyroid. If such conditions are induced by deranged functioning of these glands, it is reasonable to suppose that corresponding racial (inherited) differences would arise from germinal changes, whose effect is to alter the quantity (or quality) of these secretions. The Caucasian,* according to Keith, shows a greater predominance of the pituitary than the Negro or Mongol, as indicated by the pronounced nasalisation of the face, the tendency to strong eyebrow ridges, prominent chin, and the tendency to greater stature and bulk of body. It is also suggested that the beardless face and almost hairless body of the representative Negro and Mongol types is due to a lesser activity of the interstitial glands, the long stork-like legs of Nilotic and other tribes resulting from a greater abeyance of the same glands.

In the same way, differences in the pigmentation of the skin, which characterise the various races of mankind, may be reasonably assumed to be due to inherited differences in the activities of the suprarenal bodies, since it is known that Addison's disease, in which, among other symptoms, there is a darkening of the skin through pigmentation, is the result of a pathological condition of the adrenal cortex. Thus, the great colour varieties of mankind are probably determined in part by differences in the activity of the adrenal bodies; but it is probable that other

* Of course, anthropologists now recognise that there is no Caucasian race, but that modern European populations are a mixture in various proportions of three distinct races: (1) Nordic, tall, blue-eyed, and long-headed (dolichocephalic); (2) Alpine, short and stocky, brown-eyed and broad-headed (brachycephalic); (3) Mediterranean, small and slender, brown-eyed and long-headed.

glands as well are concerned in the determination of skin pigmentation, and we have already indicated some of the other racial differences which they probably control as well. If, then, in the various races hereditary differences in the activities of these glands of internal secretion are concerned, it may be expected that the results of racial crosses will be very different from what they would be if there were direct determiners for the various individual visible characters. For each endocrine (ductless) gland has various activities and affects the development of many parts of the body. In crosses between races, whole complexes of characters would then be expected to be inherited or modified together. If the difference between a white and a black skin is due to the greater activity of the suprarenals in the white race, then it would appear that quantitative differences in the activities of these organs are the units really involved in white-black crosses. The laws of quantitative inheritance are by no means clearly understood at the present time, nor are even the facts of colour inheritance in mankind entirely agreed upon (see p. 52); but if they are due to inherited differences in endocrine activity, we have here the basis for a further analysis and understanding of the combined phenomena of blending and segregation in the colour inheritance of racial crosses.

The thyroid is considered by Keith to be anthropologically the most important of all the endocrine glands. The thyroid, like all these glands, is believed to throw off two types of substances,* one which is

* It may be questioned whether there are really two types of substances given off, one early in development and the other after maturity. It appears rather that a germinal change in, for example, thyroid production causes morphogenetic changes which will be inherited, while a functional derangement of the same kind occurring later will produce different results and not be inherited.

morphogenetic and affects the development, the other which controls and regulates in a remarkable manner various activities of the body through the minute traces of certain substances which it pours into the blood. This latter substance in the case of thyroid is known as thyroxin. It has been isolated and its chemical structure determined, the molecule being found to contain iodine and arsenic. About 150 grains were obtained from some 6,000 pounds of ox thyroid, so that the amount of thyroxin poured daily into the blood of a man must be almost too infinitesimal for computation. The condition known as myxœdema, which is accompanied by peculiarities of the skin and hair, disappears when thyroid extract is administered. Berman (1921) cites the fact that, as early as 1891, sheep thyroid was administered to a woman with myxœdema.* The symptoms disappeared, but she was obliged to continue taking thyroid extract until her death, in 1919. In this period of twenty-eight years she consumed nine pints of thyroid, equivalent to the extract from the glands of 870 sheep.

Hence, the thyroid acts directly on the skin and hair, which are the chief structures used in the classification of the races of mankind. It also affects the skeleton, and when deficient, causes, according to Keith, arrested development of the basal part of the skull, the root of the nose appearing to be flattened and drawn backwards between the eyes, the upper forehead projecting or bulging, the face being flattened, and the bony scaffolding of the nose greatly reduced. These are all characteristic features of the Mongolian

* A condition with dropsy-like swelling caused by failure of nutrition from defective nerve influence. It is associated with atrophy of the thyroid, and is probably directly due to excess of mucin in the system. It is accompanied by sluggish movements, thick speech, and dull mental condition.

face, and to a lesser degree of the Negro face. Hence, it is concluded that a reduction or alteration in thyroid activity has been a factor in determining some of the characteristics of these races. The Mongol might be characterised as subthyroid relatively to the white man, while the negro is relatively subadrenal. Similarly such Eastern races as the Malays, Siamese, Chinese, and Japanese, having nearly hairless faces and little hair on their bodies, may be classed as in some respects eunuchoid, with a weak secretion from the adrenal cortex. They are, however, vigorous and prolific, and these are not eunuchoid characteristics. The social dominance of the white man might, then, be said to be due to the greater concentration of certain hormones in his blood.

Achondroplasia (see pp. 34, 39) is a form of dwarfing due to hypothyroidism, and is inherited. In man it may be accompanied by shortening of the face (prosopia), as in the bull-dog, or the face may be unaffected, as also in the dachshund. The latter condition is much less common. Short limbs and a long trunk, accompanied by retraction of the nasal region of the face, are all, according to Keith, Mongolian characteristics. The so-called Mongolian idiots (see p. 152) are stunted individuals, imbeciles with Mongoloid features. Their occurrence among Caucasian offspring is not an indication of Mongol ancestry outcropping, but is a form of hypothyroidism. On the other hand, enlargement of the thyroid causes goitre, and there are particular regions, as the vicinity of the Great Lakes of North America, where goitre is more frequent owing, apparently, to insufficiency of iodine in the water.* According to Berman (1921), the thyroid also controls the speed of living. With more

* There is some evidence that goitre is concerned with a specific bacillus, one host of which is the goat, and that it may be conveyed by contamination of drinking-water.

thyroid one thinks and acts more quickly. One milligram of thyroxin is found to increase the rate of metabolism 2 per cent. Cretin babies fed on thyroid undergo a remarkable mental and physical transformation to normal human beings. But they must be fed on it all their lives, or they relapse into their former condition, because they are incapable of producing the secretion themselves. More recently Keith (1922) has elaborated his views on this subject in an extremely interesting way, discussing such subjects as the Neanderthal skull, acromegaly, dwarfism, and many other anatomical alterations from the point of view of hormone control.

Seligman (1904) has described the frequent occurrence of "cretins" in Dexter Kerry cattle. The breed appears to have originated, at Kerry at least, as early as the middle of the eighteenth century. One of its most striking features is the very short legs, which suggest a condition of hypothyroidism. In one herd fourteen cretins were produced among fifty-five calves in seven years. Another herd produced five cretins among twenty-seven calves in three years. These "bull-dog monsters" are non-viable, and abnormal in many respects. Their chief peculiarities are their short trunk and extremely dwarfed limbs (humerus only 13 millimetres in length), the extreme brachycephaly of the head with its rounded forehead bulging over the very depressed nose and upper jaw, while the lower jaw is normally developed. There is always a gap in the abdominal wall through which the internal organs protrude. The palate is cleft, the tongue long and protruding, while the thyroid is irregularly developed, and shows the same histological peculiarities as the thyroid of cretin children. It was probably devoid of proper secretion, as the extract of such glands produced little or no fall in blood pressure when injected intravenously.

This condition of cretinism is said to be constantly associated with placental disease, which would prevent the thyroid hormones of the mother from acting properly upon the young. The frequent occurrence of cretinism in this breed of cattle may, then, perhaps be accounted for by a diseased placenta preventing the already hypothyroid mother from furnishing her offspring with sufficient thyroid secretion. There is another explanation, however, which appears more probable. In at least one case a cow is known to have produced a normal calf following a cretinous one. Any defect in the placenta would then probably not be the result of a diseased condition of the cow, but rather the initial defect would be in the developing foetus. Another fact which may be significant is the occurrence of 25.4 per cent. of "cretinous" offspring in the larger herd already referred to. This clearly suggests that the condition is a Mendelian recessive, due to a lethal mutation carried in the germ plasm of the breed, or in some of them. Further data would be required in order to verify this hypothesis.

Sir Arthur Keith applies the same conceptions of hormone determination to the anthropoid apes and other vertebrates, holding that in the orang there is a predominance of thyroid, while in the gorilla the pituitary is predominant. However this may be, the view seems well founded that racial differences in man, including the colour and character of the skin and hair, differences in physiognomy and in stature and the relative length of limbs, are related to inherited differences in the activities of various endocrine glands. This thesis will, no doubt, be further elaborated with increasing knowledge.

The bodily changes associated with pain, fear, and rage have been particularly studied by Cannon (1916), who showed how in a state of fear or anger adrenalin is poured into the blood, which causes reactions,

putting the body into a state of defence in the most marvellous way. The substance adrenalin is derived from the medulla of the adrenal glands. It has been chemically synthesised, and Schaefer showed that when injected into the veins it raises the blood-pressure. Its concentration in the blood is only about 1 part in 20,000,000, and 100,000 times this quantity is held in the gland ready for emergencies. Cannon showed that when secreted into the blood, as a result of the emotions of fear or anger, it prepares the body for mortal combat by summoning its reserves and increasing its defences. It stimulates the liver to pour out more carbohydrates. The blood is thus flooded with sugar which can immediately be used as fuel for the body in exertion. The number of red corpuscles in the blood is also increased, the blood is withdrawn from the skin and viscera and sent to the muscles, heart, lungs, and central nervous system. The limbs actually grow larger with their increased blood supply, the heart beats faster, and the senses are keener; the effects of fatigue are abolished, and the blood is rendered more coagulable. All these purposive reactions of the body depend upon the presence in the blood of a slightly increased amount of adrenalin. The administration of adrenalin to animals also causes their blood to clot more quickly, erects their hair, and dilates their pupils. Adrenal excess, due to hypertrophy of the cortex, causes high blood pressure, and in women a tendency to masculinity. Depletion of the adrenal reserves, on the other hand, leads to the conditions known as neurasthenia, nervous breakdown, chronic fatigue, and shell shock.

If differences in endocrine activity are characteristic of the races of mankind, then such differences are inherited. Are smaller glandular differences between the individuals of the same race inherited? This thesis is supported by Berman (1921) in a book on the

Glands Regulating Personality. The qualities constituting personality have long eluded analysis. In the Middle Ages the problem was viewed as one of humours in the blood, giving rise to a bilious, lymphatic, nervous, or sanguine temperament. If personalities are determined by the quantities of various hormones poured into the blood by the endocrine glands, then the old conventional view was not so very far wrong after all, although, of course, the views of the Middle Ages had no such definiteness. It is not improbable, as Berman holds, that each individual has inherited a certain constellation of endocrine activities, but it seems likely that he has exaggerated their all-importance in the determination of the personality. He recognises three types of personality, thyroid-centred, pituitary-centred, and adrenal-centred, regarding all personalities as combinations of these. Each of the three types, he says, is "stamped with a significant figure, height, skin, hair, temperament, ambition, social reactions, and predisposition to certain diseases." Individual facial types are also regarded as the expression of endocrine differences. Whether the forehead is broad or narrow, the distance between the eyes great or small, the character of the eyebrows, the shape, size, and appearance of the eyes, the mould of nose and jaws, and peculiarities of the teeth—all are regarded as determined by hormone differences. Indeed, the individual is looked upon as a complicated pattern of designs traced by the hormones. Only after a further analysis of the relation of hormones to the hereditary determiners which produce fixed quantitative differences in their activities can it be determined whether such a view is too extreme. It has to be remembered, in any case, that differences in the nervous system are also inherited.

Shelley's face is characterised by Berman as hypo-

thyroid, with its oval shape, delicate features, wide, high brow, large, prominent, and vivacious eyes, and sensitive lips. A hyperpituitary face, on the other hand, is distinguished by its low and narrow shape, square protruding jaw, high, thin, straight nose, marked cheek-bones and eyebrows; while a subpituitary face is round with receding chin, fat cheeks, and broader and flatter nose. The physiognomy and character of various men are also analysed in terms of internal secretions. Napoleon and Nietzsche are regarded as pituitocentric, Darwin as a neurasthenic, pituitocentric genius, Cæsar as a pituitocentric epileptic with too much adrenal and post-pituitary secretion. This method seems at present something like the older phrenology, where much latitude was left to the imagination. But it seems clear that various differences in endocrine activity are inherited, and with further knowledge this may form a satisfactory basis for the analysis of personalities and their inheritance. It is easy to understand that if a personality is in part determined by the relative activity of several endocrine glands, these being in turn determined by various factors or genes located in different chromosomes of the germ plasm, then the recombinations of such factors in later generations would give a complicated situation very difficult to analyse, but one in which various elements of personality might still be said to be inherited. Even if the personality depended entirely upon shifting cross-currents of hormone control, it would be extremely difficult to investigate the inheritance of the germinal factors which, in turn, determined plus or minus variations in the activities of the various endocrine glands, because each gland produces many effects, and some of these effects overlap or reinforce each other. If the hormone view of personality has any sound basis, then each personality, both in

physical configuration and in mental activities, is a palimpsest of cross-patterns and developmental currents blended into a unified whole. But many elements of the personality must also be determined by mental differences based on inherited differences in the nervous system.

THE RESULTS OF CROSSING BETWEEN RACES.

Eugenic writers differ, according to their social and political bias, in the stress they lay upon a democratic or an aristocratic society as the basis for eugenic improvement. This difficult question we need not touch upon here, except to point out that the methods of eugenic selection may differ somewhat in the two cases. The stratification of society in older civilisations appears to be a natural process (*cf.* Flinders-Petrie, 1911), which has often been at first acquiesced in rather than promoted by human arrangements, though ultimately petrified and perpetuated by some form of caste. An aristocratic society might be supposed to be composed of strains which were more or less "pure lines" as regards their distinguishing characteristics, but this is seldom, if ever, the case. The chief reason, of course, is that society is so largely founded upon monetary considerations, and each class is therefore continually receiving recruits from other classes. In a population of real pure lines, such as wheat or garden beans, the process of selection for any given quality is simpler than in a hybrid population, for it consists merely in finding one or a few individuals with the desired qualities, and giving them the opportunity of increased propagation.

On the other hand, an obvious weakness of an aristocratic society from the point of view of eugenics and heredity is the fact that while titles are usually

conferred in the first instance as a recognition of exceptional ability or initiative, yet the inheritance of that ability will probably follow different rules in different cases, and eldest sons are as likely as not to receive other qualities from their father, but not his ability. Ability, like genius, is probably often due to a fortunate concatenation of favourable elements, and if these are independently inherited the chances of their reappearance in the offspring are small. Nevertheless, it must be admitted that the exceptional individual has a much better chance of transmitting his qualities, or some of them, than the average individual can possibly have. Yet titles, no doubt, often long survive any expression of exceptional qualities in their holders. And once the quality is gone, through having failed to be inherited, cross-breeding alone can bring it back. Would it not seem, then, that society founded upon ability and quality, and not upon wealth, in which there was also a measure of latitude in intermarriage, would be in consonance with the eugenic ideal?

While, therefore, intermarriage of diverse strains is important, both from the point of view mentioned above and on account of the increased vigour resulting from a heterozygous condition, yet there are important limitations to the width of the crosses which are desirable. In the newer countries, such as North and South America and parts of Africa, the cross-bred races which have sprung up through miscegenation between Europeans and more backward peoples are at a disadvantage from almost every point of view. Physical disharmonies result, such as the fitting of large teeth into small jaws; or as Davenport (1917*b*) points out, large men with small internal organs, or inadequate circulatory systems, or other disharmonies which tax the adjustability of the organism, and may lead to early death. (But see p. 29.) Segregation

of characters thus results in a motley assortment of types, with some primitive and some advanced mental, moral, or physical qualities in place of the original more or less blended condition in the first generation of the cross. It is questionable even if marriages between North and South European races are always wholly desirable in their results; although history shows, on the other hand, that the intermixture of more closely related races is beneficial as supplying increased vigour and a greater range of alternative characters, to increase the potentialities of the population or for selection to play upon.

Not only within the historical period (see, for example, Haddon, 1919), but also among the races of Neolithic and Palæolithic man there is evidence of the frequent shifting of peoples in various parts of the world. Sometimes the defeated race was driven out or exterminated, but very often such migrations resulted in the fusion of two races into a new unit ultimately having certain uniform and distinctive features. It is evident that hybridisation has been going on in this way at intervals throughout the history of man. It does not follow, as some writers assume, that crossing is the cause of the evolution, but it does follow that the great majority at least of modern races are hybrid in origin, although they may have become quite uniform through isolation and inbreeding. The fact is that any racial unit contains the potentialities of innumerable minor races if these could be separated out and inbred. The range of migration of a people is an important element in determining how many distinct types will occupy a given area of territory. When the Indian tribes of the central plains of North America took to a nomadic life after the introduction of the horse, many of the tribal differences between them quickly disappeared. Differences can only grow up in a condition of

isolation. This evolutionary principle of isolation is of enormous importance and has usually been overlooked by anthropologists.

The question is often discussed as to whether modern man is a single species or more than one. The fact that all the races of mankind are fertile with each other is no longer a sufficient reason for classing them as one species. The present generation of naturalists is describing innumerable species of plants and animals as distinct species, although they are perfectly fertile with each other. Sterility as a criterion of species has almost completely broken down. The origin, causes, and nature of inter-specific sterility are still largely obscure. On the one hand, species of *Drosophilă*, so closely similar that they are scarcely distinguishable even by experts, may show complete sterility with each other or, at least, provide only sterile hybrids;* while, on the other hand, all the species of cattle (*Bovidæ*) are inter-fertile, although many of them show striking differences. In mankind the differences between the five great colour varieties are not merely in the skin colour, but also in such points as stature, hair colour and shape, cranial conformation, facial peculiarities, skin secretions, and intelligence. These differences are quite as distinctive and varied as those between many described species of higher animals. Such differences could only have grown up during long periods of isolation, and can only be maintained by isolation or an absence of crossing. The five colour types of mankind also occupied, until modern transportation began, more or less markedly separated

* Even more extreme are the various cases of self-sterility in plants, in which many of the individuals are sterile with their own pollen. In such cases as *Primula*, crosses between individuals of the same species but having different types of flower are more fertile than self-fertilised plants.

areas of the earth's surface, although where the yellow and brown races, for example, are in contact in south-eastern Asia a gradual transition occurs between them. Where evolution has been going on independently in these races for such long periods, and some races have progressed far beyond others, both mentally and culturally, it is folly to suppose that crosses between a progressive and a primitive race can lead to a desirable result from the point of view of the advanced race, or even of the primitive race. Many native African and other tribes are in the Stone Age, so far as their culture is concerned, and it cannot be expected that their mentality has advanced beyond that period. The mental status of the average Palæolithic man is difficult to determine. Although the mental capacity of modern man has not increased during the historical period, yet it is necessary to suppose that the development of the human mind has consisted in something more than the mere accumulation of tradition. In other words, there has been a real evolution in which the mind has been one of the reacting elements. The mental level of the *average* Palæolithic man can hardly have been higher than that of our modern feeble-minded. The Australian black-fellow appears to be an early Palæolithic survival, resembling Mousterian man, and wholly incapable of coping with the white man's civilisation. It is clear that other races represent different stages of mental development.

This, of course, is often disputed, and it is frequently held that Palæolithic man was potentially the mental equal of modern civilised man. This depends on the sense in which the term "potential" is used. The important point is that primitive races are largely incapable of taking hold of the white man's civilisation and profiting by it, or adapting it to their own use, except in a primitive way. No doubt, as Carr-

Saunders (1922) holds, man's mental evolution has consisted largely in the handing down of accumulated tradition, but there must also have been a reaction of man's mind—that is, a mental evolution—in order to make the continued accumulation and advance of tradition possible. That such a mental evolution has accompanied the accumulation of tradition is evident from the recent history of the Japanese. They were able in one generation to absorb a great part of Western science and begin making independent contributions to that science. This remarkable phenomenon, resulting from contact with Western civilisation, has not been approached by any truly primitive people, which shows that primitive peoples would require a long period of mental evolution before they were capable of grasping or profiting by the views of nature held in the civilised world.

As we have already pointed out, crossing between more or less related races or tribes of mankind has been going on at intervals throughout the whole of historical and prehistoric time. Nevertheless, at any given period it has usually been confined to definite areas of contact between tribes, and has been very limited in its scope, except at times of migrating or shifting populations. Primitive man, in particular, was far less of a roving animal than is commonly supposed. This is shown by the great number of local native tribes which existed among the Indians of North and South America at the time of their first contact with European civilisation. Such differentiation, like that of any other species, could only have occurred under conditions of relative isolation and segregation—*i.e.*, absence or infrequency of intermarriage. Carr-Saunders (1922) has pointed out that as soon as early man began to have any social organisation at all, probably even as early as the Upper Palæolithic, families and groups began to develop

hunting and fishing and general food-getting rights over fixed limited areas. Among the primitive races of modern times these conditions continue. For instance, in parts of former German South-West Africa, where the chief Hottentot food-plant on parts of the coast is a gourd, *Acanthosicyos horrida*, growing on the sand-dunes, individual families and groups have vested rights over the fruits of this plant in local areas, and it annually saves their lives and serves as a source of both food and water until other food is obtainable. Native groups are, then, not free to wander at will wherever fancy dictates, but each party is confined to a limited area, whose boundaries are definitely known to them. This fact, that each group is definitely tied to a local area by recognised custom and is often at war with its neighbours, adds greatly to the stability of any savage population, and probably lessens the amount of exogamy between unrelated families. These are the conditions under which local tribes and differentiated groups might be expected to grow up. Such a process of differentiation is, however, very slow, and the spread of culture from group to group will also tend to the maintenance of uniformity. Nevertheless, cultural differences, owing to local environmental conditions, will arise long before structural differences appear, and in the tribes of North American Indians such structural differences seem to have been very few. Languages, on the other hand, were many and often widely different (though showing evidences of a common origin), which implied a long period of cultural isolation.

The results of crosses between such related tribes are relatively insignificant, the differences involved being less than those between the peoples of European nations. Crosses between equally primitive or equally advanced peoples of similar culture involve no very

serious problem. Inter-crossing between races more remotely related, especially when one is primitive and the other advanced, immediately involve problems of the utmost difficulty—problems which may be said to have arisen seriously only in modern times. These problems require study in three separate aspects: (1) In crosses between primitive races; (2) in crosses between a primitive and an advanced race; (3) in crosses between advanced races. In each case the results of the particular cross must be taken into account. For instance, crosses between Europeans and Bantu peoples might be undesirable from any point of view, while marriages between Europeans and Polynesians might conceivably produce a more felicitous result.

Wallace (*Malay Archipelago*, p. 335) states that "Everywhere in the East where the Portuguese have mixed with the native races they have become darker in colour than either of the parent stocks"; but that "the reverse is the case in South America, where the mixture of the Portuguese or Brazilian with the Indian produces the 'Mameluco,' who is not unfrequently lighter than either parent, and always lighter than the Indian." Such results might be expected if skin colour were controlled by differences in the activity of various endocrine glands.

Very few serious studies of the results of racial crossing have been made, and probably no field of anthropology could be more profitably explored at the present time. The Pitcairn and Norfolk Islanders would form a valuable basis for such a study. They are descended from ten English sailors, who mutinied in a voyage to Tahiti in 1788, and with eighteen native Polynesians (six men and twelve women) formed a colony on the little island of Pitcairn. In 1856 the resulting population of 200 overflowed to Norfolk Island, and the descendants of this crossed

204
204

race on the two islands now number about a thousand. They should form excellent material for an anthropometric study of a population descended through several generations from original crosses between English and Polynesians.

The most ambitious of such studies which has yet been made is probably that of Fischer (1913) on the Rehoboth hybrid people inhabiting a portion of the area which was formerly German South-West Africa. These people were derived from crosses between Hottentot women and Boer men, which began over a century ago. They now number, perhaps, 3,000. In a general anthropological and ethnographical study of these people, Fischer concludes that they are a well characterised but very variable group. The characters of the parent races are combined in the greatest variety of ways, showing continued segregation, and not a permanent blend. The first crosses are, in general, intermediate, and when crossed back with either race, they resemble more the race with which they were recrossed. They are said to be sound, strong, and very fertile, having an average of 7.4 children per family. The inheritance of individual characters, such as hair form and colour, eye colour, skin colour, shape of nose, nasal index, form of eyelid, breadth of forehead, etc., was studied and found to show alternative inheritance; but the observations, while valuable, are scarcely sufficiently detailed to furnish critical evidence on all these points. Nevertheless, a body of valuable data of inheritance is brought together. An important conclusion reached is that the size of body and length of face is greater than in either parent race, while the fertility is found to be undiminished and the sex ratio unaltered.

The latter conclusion is, however, not in harmony with the statistical data on the sex ratio in hybrids obtained by other investigations. Thus, Pearl and

Pearl (1908) examined the vital statistics of the city of Buenos Ayres, where Italian, Spanish, and Argentine crosses take place, the last being itself a mixed race. The data extended over a period of ten years, and made possible the comparison of the sex ratio in pure matings with that in crosses. In the former case the ratio was 102.21 : 100, in the latter 105.99 : 100, hence a greater excess of male offspring from cross-matings. Little (1919) has made a similar study of the sex ratios from the records of a lying-in hospital in New York. These records, unlike the previous ones, included still-births, and the types of matings included (1) those within each of the following nationalities: English, Irish, Scotch, Italian, Russian, Greek, Austrian, and German; (2) all possible first generation matings between members of these nationalities. The results gave a sex ratio of 106.27 for the pure stocks, and 121.56 for the crosses. This indicates an even more marked increase of male births in the hybrid stocks than the Argentine statistics. Separate examination of the data for still-births indicated that they were more frequent in the pure races than in the crosses. These results indicate that in crosses between European races there is a higher ratio of male births and a lower frequency of still-births, at least in the first generation. The latter is probably a result of hybrid vigour. That crossing a species may alter the sex ratio of the offspring in very marked degree has also been shown in the case of pigeons and other animals.

Returning to the subject of racial crossing, reference may be made to a short study of racial mixture in Hawaii (MacCaughey, 1919). In these islands intermarriages of Portuguese, Spanish, Hawaiian, Chinese, Japanese, Americans, English, and other Europeans are taking place. The population containing this remarkable diversity of races

numbers about 246,500, the Japanese predominating in numbers. From a decade of observation of this microcosmic melting-pot, the conclusion is reached that such racial intermingling is usually undesirable in its results. Most of the Caucasian*-Hawaiians seem to blend the least desirable traits of both parents, and intermarriages of North European and American stocks with dark-skinned races are considered biologically wasteful.

Similarly Lundborg (1920), from a study of Swedish conditions, concludes that the crossing of races degenerates the constitution and increases degradation. He finds such crossing much more common in the poorer and lower classes, while the middle classes are more homogeneous. In the lower classes are more frequently found individuals with other race characters—*e.g.*, darker hair and eyes. Mjoen (1922) has examined the results of crosses in Norway between the Nordics and the Mongoloid Laplanders. He found the first generation to be taller and heavier than the tall Nordic parent (owing to heterosis), but that this increase in size is lost in later generations. Also, frequently in crosses between Lapps and Norwegians, especially when Alpine blood was also present, a mentally unstable type is produced, the lack of balance being shown by stealing, lying, and drinking. A similar unbalanced type frequently arises from crosses between American Indians and French or English. The writer concludes that as regards these matings, the pure races have the advantage in every way. For example, the incidence of tuberculosis is the lowest (1.1 to 1.5) where the Nordic race is comparatively pure, and highest (3.6 to 4) in the region where there is the largest race mixture.

As regards world eugenics, then, it would appear

* This loosely used term is meant to include Europeans and Americans belonging to the "white" race.

that intermixture of unrelated races is from every point of view undesirable, at least as regards race combinations involving one primitive and one advanced race. It is possible that crosses between an advanced and a native race may be advantageous as leading to progress in certain tropical regions where the white man cannot survive, although the results of such interbreeding in various tropical countries do not lead to a very hopeful outlook. But the melting-pot conception is being discredited by eugenic writers in the United States, where intercrossing has been taking place on a great scale. It may now be recognised that while interbreeding of related races or strains gives increased vigour, at least in the F_1 generation, crosses on a large scale between more distant races which have for ages been separately evolving create unnecessary problems, and are, for the most part, wholly undesirable in their results. The more advanced race is diluted and degraded by such intermixture, and primitive mental and moral characters are placed on a level with the more highly evolved. Moreover, Goddard (1917), in discussing mental tests for immigrants into the United States, states that the average steerage passenger is of low-grade intelligence, perhaps even feeble-minded. He examined six small groups arriving at Ellis Island, by means of the Binet scale tests, and found that only 2 in 148 scored as high as twelve years, which is regarded as the line between feeble-minded and normal. These people included Italians, Russians, Jews, and Hungarians. His conclusion is that there is a high percentage of feeble-minded among the present immigrants.

Even after a thousand years of intermarriage, separate racial traits may still be traceable in the modern Englishman. The blend is only a blend when considered *en masse*. Alternative inheri-

tance, and more or less complete segregation, still appear as regards single characters. The various types of modern Italian, viewed in the light of their history, appear to show the same thing. Although innumerable racial unions have taken place in the history of mankind, yet the elements distinguishing the original races appear, for the most part, to retain their separate identity and independent transmission in inheritance. The resulting race considered as a population will be a blend of the original races, yet, for a long period at least, the elemental differences continue to be separately inherited. Whether, ultimately, a real blend occurs is uncertain, but if it ever does this may be only after a thousand years or so of interbreeding within the hybrid race. In any case the racial elements of the more primitive stock will dilute and weaken the better elements of the more progressive stock, with a retarding or degrading effect on the progressive stock as a whole. It is, therefore, clear that miscegenation between, for example, the white races and African races—which for ages have been undergoing separate evolution which must have been at very different rates, assuming that both are descendants from the same original stock—is wholly undesirable from a eugenic or any other reasonable point of view.

Yet it cannot be gainsaid that the negro in the United States, through interbreeding chiefly with the lowest strata of whites, is already producing a visible effect on the colour and features, and surely also on the mentality of those elements. Unless this process is checked, the ultimate result would appear inevitably to be a gradual incorporation of these more primitive elements in the whole population. The brain of the average negro weighs 3 or 4 ounces less than that of the average white man, but this in itself does not necessarily prove a lower intelligence, because it is

well known that men of exceptional ability frequently have small brains. Ferguson (1921), in a sane discussion of the mental status of the American negro, concludes that psychological study of the negro indicates that he will never be the mental equal of the white man. Comparison of school children in the elementary grades shows that only 20 or 25 per cent. of negro children equal or exceed the average score of white children. But the term " negro " in these and other American statistics includes every grade of mulatto, and the latter may, of course, inherit the ability of their white ancestor. If only pure negroes were considered, their average mental ability would probably be much lower. The United States census of 1910 showed that mulattoes constituted approximately one-fifth of the coloured population, a fraction which continues to increase and is now probably one-fourth. Mental tests of coloured children in schools show that, on the average, lighter skin goes with higher intelligence.

The American army intelligence tests showed a still more marked difference between whites and blacks. Only one-third of the negroes were sufficiently literate to read a newspaper or write a letter, while three-fourths of the whites passed this test. The result was probably partly due to a difference in educational opportunities, but the Binet tests, which measure ability apart from education, showed that only 20 to 25 per cent. of the " negro " recruits equalled or exceeded the average white recruit. Moreover, the percentage of mulattoes among the literates was about twice as great as among the illiterates, and when the illiterates were removed from a " negro " company its complexion was thereby notably lightened. While the negro's mental status is thus undoubtedly more primitive than that of the white man, yet there is apparently no evidence for the

doctrine that his mental growth ceases at adolescence. Many writers regard the negro as a case, not of arrested mental development which might be overcome by educational effort (although the utmost effort in education does not prevent the arrest in mental development of the feeble-minded), but of a primitive mentality with less control of the impulses and emotions and less ability to deal with the abstract or symbolic. The wisdom of Booker T. Washington's programme of manual education for the negro as most appropriate to his mental status is clearly shown. As far as the muscular and nervous systems and the sense organs are concerned, there is apparently no great difference between negroes and whites, but that physical differences exist is shown by the data in the following paragraph.

Love and Davenport (1919), from an analysis of the sick reports of American troops in camp in the United States during the war, find some notable differences between white and coloured troops. That negroes are relatively lacking in resistance to tuberculosis and pneumonia is shown by the fact that the rate for tuberculosis was over twice as high among coloured troops, while for pneumonia it was two or three times as high. The rate for venereal disease is three or four times higher in coloured troops, epilepsy, hysteria, neuralgia, and hæmorrhoids are about twice as frequent, addiction to drugs is more common, while skin diseases are less common than in white troops. That not only the skin but also the lining of the mouth and naso-pharynx is more resistant,* is shown by the lesser frequency of diphtheria, scarlet fever, German measles, and influenza. The nervous system of the negroes also showed less liability to neurasthenia and alcoholism, eye and

* It seems more probable that the greater incidence of respiratory diseases among negroes is due to their wide flaring nostrils.

ear defects were about half as common as in whites, and there were fewer cases of metabolic disturbance, such as diabetes and urinary calculi. It thus appears that the negro is a better animal as far as eyes and ears are concerned, has a more protective skin and a less easily deranged metabolism, but is less resistant to diseases of the lungs and pleura and to some of the general diseases.

Discussing the results of the mingling of races in the United States through immigration, Davenport (1917) states that nearly two-thirds of the 9,000,000 population of New York State are foreign born, or of foreign or mixed parentage. Nearly all the European countries are represented, most of them by many thousands, and intermingling of races in the country at large is taking place on a scale never before approached in the history of man. The irregular dentition which makes orthodontia a recognised branch of dentistry may be a result of disharmonies between teeth and jaws in the various crossed races, a condition in marked contrast with the regular dentition of native races, though such conditions may also arise from malnutrition. Davenport concludes that miscegenation commonly results in disharmony of physical, mental, and temperamental qualities, often leading to disharmony with the environment and consequent unhappiness. A hybridised people will tend to be restless, dissatisfied, and ineffective; the high death-rate in middle life may be due to bodily maladjustments, and much of the crime and insanity to the inheritance of badly adjusted mental and temperamental differences. It is probable that in such a very heterogeneous mixture, in which there has been, until recently, little selection or often even negative selection of the original immigrant elements, the disadvantages and disharmonies more than offset any advantages that may accrue from crossing. To

look for a higher racial type from the indiscriminate blending of such elements appears to be the height of folly.

All general problems of race and movements of population are closely connected with questions of birth- and death-rates. In an able analysis of the causes of death in man from an evolutionary and embryological point of view, Pearl (1920) has shown, from statistics of the United States, England, and South Brazil, that man's greatest enemy is his own endoderm. In the two former countries about 57 per cent. of all deaths which are biologically classifiable result from breakdown and failure to function of organs derived from the endoderm in their embryological development. Only 8 to 13 per cent. of deaths result from breakdown of ectodermal organs, the remaining 30 to 35 per cent. being ascribed to organs of mesodermal origin. The endoderm has been least differentiated in evolution, and hence is least adapted to resist the vicissitudes of environment. Sanitary and public health measures are largely directed to softening the asperities of the environment, so that the relatively inefficient and primitive endoderm can cope with it. Organologically considered, the respiratory and alimentary systems are most largely responsible for human deaths. Then follow in order the circulatory and nervous systems, the kidneys, sex organs, skeletal and muscular system, the skin, and finally the endocrinal system or glands of internal secretion. Differences in the efficiency, structure, and functioning or tendency to disease in all of these groups of organs no doubt exist and are inherited. In this way the factor of heredity directly affects the death-rate in families, and is often an important element in determining the age at which death will take place.

It is now well known from the statistical records of

civilised countries that birth-rates and death-rates usually rise and fall together. A very good discussion of the subject is by Dean Inge (1919). Notwithstanding the numerous factors which have been ascribed as causes of the waxing and waning of birth-rates, populations, and civilisations, we are still largely in the dark as to the fundamental biological significance of these fluctuations. Did the ancient civilisations fail to maintain themselves on account of climatic changes, soil sterility, malaria, infanticide, losses in war, inbreeding, natural sterility, or racial *ennui* and hopelessness of outlook? All of these causes may have been operative in particular cases, but none of them appear to be adequate to account for the submergence of, for example, the classic civilisations of antiquity. We see the sweep of biological wave on wave of population, but the nature of the operative forces which produce these tides is too complex for analysis with our present knowledge.

A recent writer (Nilsson, 1921) discusses the downfall of Greece and Rome from a racial and biological point of view. He points out that both countries apparently took their origin by the establishment of races by isolation and inbreeding after a mixture or invasion of races had taken place. There was a great diversity of races in the Roman Empire, and Roman rule tended to mix them up. Previously isolation and inbreeding had kept them relatively fixed and developed them as relatively pure races. Under the shelter of Roman peace and Roman administration they mingled, and the result was unlimited hybridising of types, destroying the many fixed types which had existed, and giving rise to instability of disposition and of culture. This blending of many races is regarded as the most destructive agency in the downfall of Rome. This would furnish

an unhappy outlook for the results of the heterogeneous intermixture which is going on in America on a scale never before equalled. Yet we can scarcely believe this is the whole story. German and Gallic tribes shifted and invaded their neighbours' territories in great numbers even before the advent of Cæsar. The immediate cause of some at least of these movements was a flood or unfavourable harvest season, which destroyed their narrow margin of food reserves and made it necessary for large numbers to seek their subsistence in more hospitable conditions. This appears to have been particularly true of some of the early Scandinavian tribes. An increasing population in relation to local climatic conditions and food-supply must then often have been the impelling power. Nevertheless, relative stability of tribal relations was maintained, and indiscriminate mingling of unrelated races only began under Roman rule.

It is also arguable that all the historic civilisations have been correlated with the presence of a race of superior courage and initiative dominating the activities of an inferior race. Their civilisation died out when the ruling race failed to maintain its numbers, either through miscegenation or from a variety of other causes.

Since about 1876 the birth-rate in various European countries has steadily declined, falling from 36 per 1,000 in England and Wales to about 24 before the war. Similarly in Germany the rate fell, with fluctuations, from nearly 41 in 1875 to 27·5 in 1913. But the death-rate dropped concurrently in England and Wales from 23·7 in 1864 to the pre-war figure of 14, and a similar decline occurred in Germany. After many wars a rise in the birth-rate soon restores the population. Statistics even show a rise in the frequency of male births during and after a war. Although it is difficult to understand how war con-

ditions can affect this ratio, yet it undoubtedly appears to be the case that in some way the ratio of male to female births is increased, so closely is the biological status of the race amenable to economic conditions like war or an epidemic. Emigration also leaves a vacant space which is soon filled up by an increased birth-rate, but as Carr-Saunders points out, the importance of emigration in this respect has been greatly overrated.

The nineteenth century was a period of rapid increase in population, both in Europe and America, but the birth-rate in Europe and in the Anglo-Saxon population of America has been falling throughout the last quarter of that century and the subsequent two decades, though there may be a temporary rise following the war. Of course, a permanent fall in the birth-rate must ultimately take place when the relatively empty countries available to the white race have been filled up. The serious feature of the declining birth-rate is its differential character, for birth control, as practised, leads to a condition in which we are breeding most largely from our worst stocks. Eugenists are agreed that the greatest need is for some method of adjusting conditions, so as to remove this menace to the future of the race.

THE PROBLEMS OF POPULATION.

Problems of population have been discussed ever since Malthus formulated his law that population tends to increase in geometrical ratio, while the means of living—food and raiment based on agriculture—only increase in arithmetical ratio, thus leading to human poverty, misery, and vice. The accuracy of this law has often been affirmed and as often denied. The fact that it led both Darwin and Wallace independently to the conception of natural selection

certainly stands to its credit. It does not follow, however, that the law is quantitatively accurate as stated, and it is in this direction that it has broken down in recent years. In the meantime the law of diminishing returns has been recognised as applying both to agriculture and industry.

The whole problem of population has recently been discussed by Carr-Saunders (1922) in a broadminded and restrained manner, and we may first give a short summary of the facts and arguments he presents. He points out that the fecundity of man has increased in comparison with that of primitive peoples. In this man agrees with cultivated plants and domesticated animals generally. Civilised man creates a reserve, not only for himself, but for his domesticated animals and plants, which enables them to function as a more prolific reproducing mechanism. This increased fecundity is due to more food and better conditions of life. In primitive races the number of children reared in a family is usually two to four, or sometimes six. Some tribes bring up only two children per family. Artificial abortions are frequent, and infanticide universal. Child mortality is high, owing to the hard conditions and lack of suitable food. The period of lactation often lasts two years or more, sometimes five or six years, or even longer. Under these conditions births are fewer than in many civilised families, and survivals fewer still, the population tending to remain stationary in numbers over long periods.*

The view of Malthus that the means of subsistence can only increase in arithmetical ratio, has long been disproved by statistics. On this point his argument collapses, for it is seen that the arithmetical ratio only holds so long as there is no advance in skill

* Darwin first directed attention to these and similar facts in his *Descent of Man*.

or improvement of methods. But the history of civilisation has consisted in just such advances, which lead in each case to a corresponding increase in yield for a given amount of labour. The law of diminishing returns, however, limits this yield, both in agriculture and in industry. This leads Carr-Saunders to the important conception of an optimum number, which he states in the following words (p. 200): "Since the laws in general are applicable to all, there will be, taking into account on the one hand the known arts of production, and on the other hand the habits and so on of the people at any one time in any given area, a certain density of population which will be the most desirable from the point of view of return per head of population. There will, in fact, under any circumstances always be an optimum number." If the population is either above or below that number, the return per head will be less. For any country there is, then, an optimum population corresponding to its agricultural and climatic conditions and industrial development. Increase in skill brings an increasingly dense population and a larger income per head, and so long as skill increases the optimum density of population will go on increasing. To Malthus the problem was one of the relative rate of increase of population and food production. With the conception of an optimum, it is one of density of population and the productiveness of industry.

An optimum number, if attained in a population, implies the maintenance of a standard of living. This number appears to be usually approached, both among primitive tribes and in civilised countries. The optimum will mean greater or less density of population, according to the fertility of the country in the broadest sense and the skill or degree of civilisation of its people. In a poor country like Patagonia, inhabited by a primitive tribe, the optimum con-

ditions may be represented by the present very sparse population. In a country like Belgium, where intensive agriculture and industry can be practised by an intelligent people, the present dense population may still represent the optimum. It is believed that many parts of India and China are over-populated, and the same was true of Ireland about 1585. Under these conditions the people lose their standards of living, and multiply up to the limits of subsistence. Such a loss of standards may result from fear, oppression, repeated plagues, or similar conditions.

The author points out that the fecundity of all animal species will tend to be regulated by natural selection. "A limit is set to the development of the strength of fecundity beyond a certain point by the fact that it cannot be to the advantage of any species that its fecundity should increase considerably beyond the point which ensures the survival of the species, as such an increase would intensify the struggle between the members of the species—this intensification of the struggle not bringing any corresponding advantages." Man inherited from his pre-human ancestor a higher fecundity than he needs. His development of intellect enabled him to circumvent or overcome the animals which preyed on his ancestors. In this way he lessened his own death-rate, but his intelligence enabled him at the same time to overcome his high fecundity by infanticide and other means. He thus escaped the disadvantages which would have come from too high fecundity—a natural fecundity which would otherwise have ultimately been reduced by selection.

That a standard of living exists among primitive peoples is shown by many features of primitive life—for example, by the fact that the young men are made to reach a certain standard of skill and attainment before they can marry. In the Middle Ages

and later the system of apprenticeships of the guilds had similar effects. Definite laws also prevented the poor, vagabonds, and wastrels from marrying. The more or less unconscious intention, as well as the result of such social regulations, was to maintain the population near the optimum by delay of marriage until a certain standard was reached, and also to limit reproduction on the part of those least fit in a social sense. There are now no corresponding restrictions on the marriage of the wage-earning classes, with the result that they soon attain their maximum income and marry earlier than the professional classes, whose maximum earning-power comes much later in life. Maternity benefits and doles furnish a further incentive to multiply. It is probable that the resulting tendency to increase in numbers out of due proportion to higher classes has the effect of lowering the standard of living of the working classes, because it is a phenomenon of over-population. Here we see how questions of quality and quantity of population are inextricably interwoven.

Carr-Saunders considers that populations have normally been stable throughout human history, and that rapid increase in numbers is the exception. In England, during the period 1880-1913, the average income per head increased from 100 to 134 in real wages. Hence there was no over-population in the country, as a whole, during this period of rapid growth in population. From 1840 to 1880 the birth-rate remained stationary.* Then the decline set in, and the birth-rate dropped gradually to about two-thirds its former value. This decline is regarded as a response to economic conditions, the earlier rapid rate of increase having ceased to be economically

* According to Dean Inge, between 1800 and 1900 the population of England increased 300 per cent., while it only increased 30 per cent. between 1700 and 1800.

advantageous. The decline is believed to have taken place first in the higher classes, because they respond more quickly to a change in economic conditions. It is viewed with considerable equanimity, even as regards its differential character, confined as it is chiefly to the upper and middle classes, the latter, through selection, including the great majority of the best elements in the community. Other writers take a much more serious view of this matter, and apparently with good reason. It seems clear, for instance, that in the United States the Anglo-Saxon stock is failing to hold its own (see, for instance, Holmes, 1921), and this is particularly true of the more highly trained graduates of the Universities. Similarly in England the decline in the birth-rate since the 'eighties has occurred chiefly in the elements of the population whose inheritance is most valuable to the nation. Once a particular stock having exceptional qualities is lost it is very questionable whether it can ever be replaced. The history of Greece and Rome and other decayed nations shows that once a human stock has disappeared, for whatever reason, it is gone for ever. An obvious duty rests upon the most highly endowed members in all ranks of society to perpetuate their kind.

Before leaving the subject of quantity in population, we may refer to some recent results on the question of population growth. Pearl and Reed (1920) have applied a logarithmic formula to the growth of population in the United States since 1790, and they conclude that the ultimate population of that country will not exceed 197 millions—*i.e.*, less than double the present population. East (1920, 1921), from a consideration of the agricultural possibilities of the country, concludes that there are about 800 million acres of arable land. If the population limit were placed at 2.5 acres per man, which is

comparable with present conditions in France and Germany, this would lead to a figure of 320 millions, to which would be added 11 millions supported on the grazing lands and forests. A total of 331 millions would thus be the maximum conceivable under anything like the present conditions of living. Long before any such density of population is reached, the younger countries would have ceased to be food-exporting, and each country would have to be self-supporting in this regard. But it is very doubtful if the American population will ever reach such a figure. These problems of racial movements and population increase are, however, beyond our present purview, and can only be touched upon here.

POPULATION AND QUALITY

Among primitive races natural selection and differential fertility act so as to tend to preserve existing types, rather than to bring about further evolution. The same appears to be true of wild species in nature generally. Under fixed conditions they tend to remain stable, any unfavourable aberrant types being cut off as they appear. But any kind of change in the conditions initiates readjustments in which selection may favour a different type, and various processes of modification may be set in motion. This must apply, at any rate, to the development of adaptations, though it apparently does not apply to many mutations.

As regards the history of man's peculiarly human qualities, it may be the case that progress in intellectual capacity came largely before progress in skill. But this evolutionary chapter of man's intellectual development remains mostly to be written. Granted the striking facts of the large cranial capacity of early human races and species, the reasons for this develop-

ment and the conditions under which it took place remain obscure. However this transitional phase from man's prehuman ancestor took place, a new era began, at least as early as the Lower Palæolithic, in which tradition began to play the most important rôle in man's subsequent development. Carr-Saunders rightly emphasises the value of tradition and its great importance in the evolution of civilisation. He concludes—and the majority of anthropologists would apparently agree with him—that “the major part of the progress in the evolution of the intellectual faculties had been accomplished far back in Palæolithic times.” The artistic and cultural achievements of Palæolithic man certainly appear to support this view, although the more artistic productions belong to the late Aurignatian and Magdalenian periods of the Upper Palæolithic. And yet we believe he pushes this conception too far when he states that modern races, representing the Palæolithic culture level, differ from modern Europeans in disposition rather than in intellect.

It is true that observers of the children of native races find that as beginners at school they are frequently as keen, or even keener, than the children of whites. But their mental development ceases early. Like the feeble-minded, they show arrested mental development.* In their native surroundings their activities may be diverted to other matters by the traditions of their fathers. This, however, can hardly be said of the negroes transplanted to America and living in the midst of civilised traditions, yet the descendants of these negroes in the present generation are shown to be inferior to white children of corresponding age in every stage of their development. Evidently primitive peoples are often lacking in the capacity for perseverance. Their lives frequently

* For a different view, see p. 248.

consist of periods of violent adventure and exertion in war or the chase, alternating with periods of quiescence. The capacity for perseverance is one of the later acquisitions of civilised man.

It is therefore difficult to follow Carr-Saunders in his statement (p. 397), that "there seems to be no marked difference in innate intellectual power" between negroes and modern Europeans. All the evidence, in fact, points to the contrary conclusion, but he ascribes this to differences merely in disposition and temperament. The same type of argument might apply equally well to the feebleminded.* As already pointed out (p. 226), the example of the Japanese, who have quickly picked up modern science and industry, in contrast with the many primitive races who are obviously incapable of doing so, is a sufficient answer to the belief that the difference involved is one merely of temperament and not of intellectual ability. This fact is sufficient to show the great gap in intellect which exists between the Japanese and really primitive peoples.

Granting, therefore, the great importance of tradition in accumulating and handing on by means of contact, suggestion, and language the accumulated skill of civilised man, yet there must have been also in connection with this process an increase of brain-power on the part of man himself. This must have taken place since Palæolithic times, although it is not clear how it came about, considered as an evolutionary process. Concomitant with this process went on the differentiation of society from its primitive beginnings, in which all the units or clans were alike—the so-called segmentary social condition which persists in

* McDougal (1921) refers to the fact that the negro, whether living in Africa, Malaysia, the West Indies, North or South America, continues to show the same fundamental physical and mental qualities.

native races—to the highly differentiated or organic condition of civilised society, in which a great variety of professions and occupations exist, and men are grouped according to their professions and not according to their descent. Carr-Saunders points out that with increasing contact between men performing the same functions, as populations increased in density, the segmentary type of social organisation necessarily gave place to the organic type, with the final result that modern human society has the highly differentiated and integrated structure and activities of a complex organism.

Another point on which we feel it necessary to differ from Carr-Saunders in his able analysis of the part tradition has played in the mental evolution of man is with regard to the differences between classes in the same society. He concludes that the direction and degree in which the intellect works is very largely determined by tradition, and that profound differences in tradition between the classes of modern society account for most of the mental differences manifested. Here, again, we believe he lays too much stress on tradition. A very considerable proportion of exceptional men break entirely with tradition in choosing their life work. The author admits that the children of the professional classes are on the average two years in advance of the children of unskilled labourers, and hence show superior intelligence. Similarly, McDougal (1921) quotes results of observations on school-children in Pittsburg, indicating a marked association between economic status of the parents and school advancement or intelligence of the children. Yet Carr-Saunders concludes that there are only slight differences in intellectual capacity between the classes. McDougal, on the contrary, emphasises the dangers associated with the differential birth-rate which has grown up during

the last half-century, and points out that the longer the social ladder has been at work passing up the exceptional members of the lower strata of society to the higher, the greater will become the innate germinal differences between classes. When this condition is accompanied by a failure of the higher strata to reproduce themselves, then it is obvious that the germinal reserves of ability in the lower classes are being gradually depleted and exhausted. This can only mean a permanent loss of power and ability to the race in which it occurs. Already McDougal sees clear indications of this exhaustion in the decreasing numbers who are passing up the ladder during the present generation. Britain seems to have gone further in this direction than any other country in the depletion of its stocks showing leadership and ability, although it is not clear that the United States, with its great numbers of low-class immigrants replacing the Anglo-Saxon stock in various parts of the country, is in any better case. These people may absorb the tradition of their predecessors in a generation or two, but it is certain that they cannot absorb their germinal qualities, nor alter those which are already present in their own germ plasm.

The problems envisaged in the last few paragraphs have been so much written about in recent years that we do not propose to discuss them further here. They remain at the heart of all questions of racial improvement through eugenic ideals. The problem of formulating laws which would foster an increase in the more efficient and desirable members in each stratum of society would seem almost to surpass the wit of man, and so far as we know, it has not yet been successfully accomplished in any community. The task appears all the more appalling when it is remembered how frequently Parliamentary laws have an economic effect quite different from that antici-

pated or intended. Probably an intelligent and enlightened public opinion is more efficacious than any laws that could be devised. And a large element of that enlightenment will consist in an understanding of the nature, the laws, and the ubiquity of heredity. However, an obvious negative measure which can be carried into effect is the prevention of reproduction on the part of undesirables, such as the feebleminded. Such measures are necessary, not so much for the improvement of the race, as for arresting its rapid deterioration through the multiplication of the unfit.

LIST OF GENERAL WORKS BEARING ON EUGENICS

- BABCOCK, E. B., and CLAUSEN, R. E. *Genetics in Relation to Agriculture*. 1918. London and New York: Hill Publishing Co. Pp. 675, figs. 239, pls. 4.
- BATESON, W. *Mendel's Principles of Heredity*. 1913. Cambridge Press. Pp. 413, figs. 39.
- CARR-SAUNDERS, A. M. *The Population Problem*. 1922. Oxford Press. Pp. 516.
- CASTLE, W. E. *Genetics and Eugenics*. 1916. Harvard University Press. Pp. 357, figs. 135.
- DAVENPORT, C. B. *Heredity in Relation to Eugenics*. London: Williams and Norgate. Pp. 298.
- DONCASTER, L. *An Introduction to the Study of Cytology*. 1920. Cambridge Press. Pp. 280, figs. 31, pls. 24.
- GALTON, F. *Hereditary Genius*. 1869. London: Macmillan. Second Edition, reprint, 1914. Pp. 390.
- Inquiries into Human Faculty and its Development*. 1883. London: Macmillan. Pp. 387, pls. 5.
- Natural Inheritance*. 1889. London: Macmillan. Pp. 259.
- GATES, R. RUGGLES. *The Mutation Factor in Evolution*. 1915. London: Macmillan. Pp. 353, figs. 114.
- GODDART, H. H. *Feeble-mindedness, Its Causes and Consequences*. 1914. New York: Macmillan. Pp. 599.
- GUYER, M. F. *Being Well-Born*. 1916. Indianapolis: Bobbs-Merrill Co. Pp. 374, figs. 39.
- INGE, W. R. *Outspoken Essays*. 1919. London: Longmans. Pp. 281.
- MCDUGAL, WM. *Psychology, the Study of Behaviour*. 1919. London: Williams and Norgate. Pp. 254.
- An Introduction to Social Psychology*. 1919. London: Methuen. Fourteenth Edition. Pp. 459.
- National Welfare and National Decay*. 1921. London: Methuen. Pp. 214.

- MORGAN, T. H. *The Physical Basis of Heredity*. 1919. Philadelphia and London: Lippincott. Pp. 305, figs. 117.
- PEARSON, KARL, and Collaborators. *Treasury of Human Inheritance*.
- PLATE, L. *Vererbungslehre, mit besonderer Berücksichtigung des Menschen, für Studierende, Ärzte und Züchter*. 1913. Leipzig: W. Engelmann. Pp. 519, figs. 179, pls. 3.
- POPENOE, PAUL, and R. H. JOHNSON. *Applied Eugenics*. 1920. New York: Macmillan. Pp. 459, figs. 46.
- PUNNETT, R. C. *Mendelism*. 1919. Fifth Edition. London: Macmillan. Pp. 219, figs. 52, pls. 7.
- SHAND, A. F. *The Foundations of Character, being a Study of the Tendencies of the Emotions and Sentiments*. 1920. London: Macmillan. Pp. 578.
- TANSLEY, A. G. *The New Psychology and its Relation to Life*. 1920. London: Geo. Allen and Unwin. Pp. 283, figs. 10.
- WATSON, J. B. *Behaviour: An Introduction to Comparative Psychology*. 1914. New York: Henry Holt and Co. Pp. 439, figs. 70.
- Psychology from the Standpoint of a Behaviourist*. 1919. Pp. 429, figs. 66.
- WILSON, E. B. *The Cell in Development and Inheritance*. 1906. London and New York: Macmillan. Pp. 483, figs. 194.

BIBLIOGRAPHY OF PAPERS CITED IN THE TEXT

- ADKINSON, JUNE. The Behaviour of Bronchial Asthma as an Inherited Character. *Genetics*, 1920, v. 363-418, figs. 39.
- ALBERT, HENRY. The Inheritance of Syndactylism. *Science*, 1915, N. S. 41, 951.
- ANONYMOUS. Hand and Foot Prints. *Journ. Hered.*, 1916, vii. 511-523, figs. 12-19.
- Brigham Young. An Illustration of Prepotency. *Journ. Hered.*, 1916, vii. 51-54, pl. 1, figs. 2.
- AREY, LESLIE B. On Monozygotic Human Twins. *Anat. Record*, 1921, xxi. 44.
- ATWOOD, EDITH S., and POND, CLARA P. A Polydactylous Family. *Journ. Hered.*, 1917, viii. 96, fig. 1.
- AULD, R. C. Some Cases of Solid-Hoofed Hogs and Two-Toed Horses. *Amer. Nat.*, 1889, xxiii. 447-449, fig. 1.
- BAKER, HENRY. A Supplement to the Account of a Distempered Skin, published in the 424th number of the *Philosophical Transactions*. *Phil. Trans.*, 1755, xlix. 21-24, fig. 1.
- BALLOWITZ, E. Über hyperdaktyle Familien und die Vererbung der Vielfingerigkeit des Menschen. *Arch. f. Rass. u. Gesells. Biol.*, 1904, i. 347-365, figs. 11.
- BANTA, A. M. Sex and Sex Intergrades in Cladocera. *Proc. Nat. Acad. Sci.*, 1918, iv. 373-379.
- BARKER, LEWELLYS F. The Relation of the Endocrine Glands to Heredity and Development. *Science*, 1922, lv. 685-690.
- BATESON, W. Materials for the Study of Variation. 1894. London: Macmillan. Pp. 598.
- Presidential Address: Report British Association, Australian Meeting. 1915. Pp. 38.
- BEAN, R. B. Heredity of Hair Form among Filipinos. *Amer. Nat.*, 1908, xlv. 524-536.
- The Racial Anatomy of the Philippine Islanders. 1910. Philadelphia: Lippincott. Pp. 236, figs. 26.
- BEELEY, A. L. Left-Handedness. *Am. Journ. Phys. Anthropol.*, 1920, ii. 389-400.

BIBLIOGRAPHY OF PAPERS CITED · 255

- BERGMAN, EMANUEL. A Family with Hereditary (Genotypical) Tremor. *Hereditas*, 1920, i. 98-106.
- BERMAN, LOUIS. The Glands Regulating Personality. 1921. New York: Macmillan. Pp. 300.
- BERNSTEIN, CHAS. Microcephalic People, sometimes called "Pin Heads." *Journ. Hered.*, 1922, xiii. 30-39, figs. 4.
- BLACKER, G. F., and LAWRENCE, T. W. P. A Case of True Unilateral Hermaphroditism with Ovotestis occurring in Man, with a Summary and Criticism of the Recorded Cases of True Hermaphroditism. *Trans. Obstet. Soc. Lond.*, 1897, xxxviii. 265-317, pls. 4.
- BOAS, HELÈNE, M. Inheritance of Eye Colour in Man. *Amer. Journ. Phys. Anthropol.*, 1919, ii. 15-20.
- BOAS, J. E. V. Zur Beurteilung der Polydaktylie des Pferdes. *Zool. Jahrb. (Anat.)*, 1917, xl. 49-104, pl. 1, figs. 51.
- BONAVIA, E. Studies in the Evolution of Animals. 1895. London: Constable. Pp. 362, figs. 128.
- BOND, C. J. On Heterochromidia Iridis in Man and Animals from the Genetic Point of View. *Journ. Genetics*, 1912, ii. 99-129, pls. 4, figs. 7.
- On Certain Factors concerned in the Production of Eye Colour in Birds. *Journ. Genetics*, 1919, ix. 69-81.
- On the Left-Sided Incidence of the Supernumerary Digit in Heterodactylous Fowls. *Journ. Genetics*, 1920, x. 87-91.
- BONNEVIE, K. Polydaktyli i norske bygdeslegter. *Norsk Mag. f. Lægev.*, 1919a, No. 6, pp. 32.
- Om twillingsfødslers arvelighet. Undersøkelse over en norsk bygdeslegt. *Norsk Mag. f. Lægev.*, 1919b, No. 8, pp. 22.
- BOTTOMLEY, W. B. Some Effects of Organic Growth-Promoting Substances (Auximones) on the Growth of *Lemna minor* in Mineral Culture Solutions. *Proc. Roy. Soc.*, 1917, 89B, 481-507, pls. 2, figs. 7.
- BOWDITCH, H. Red-green Colour-Blindness in Three Allied Families. *Journ. Hered.*, 1922. xiii. 139-142, fig. 1.
- BRIDGES, C. B. Triploid Intersexes in *Drosophila melanogaster*. *Science*, 1921, liv. 252-254.
- BRIGGS, H. H. Hereditary Congenital Ptosis with Report of Sixty-four Cases conforming to the Mendelian Rule of Dominance. *Trans. Amer. Ophthalmol. Soc.*, 1918, xvi. 255-276.
- BRISTOL, C. L. Otter Sheep. *Amer. Nat.*, 1908, xlii. 282.
- BROOKS, W. K. Heredity and Variation: Logical and Biological. *Proc. Amer. Phil. Soc.*, 1906, xlv. 70-76.
- BRYANT, F. A. Influence of Heredity in Stammering. *Journ. Hered.*, 1917, viii. 46-7.

- BUCHANAN, J. ARTHUR. The Mendelianism of Migraine. *Med. Rec.*, 1920, xcvi. 807-8.
- BULLOCH, W. Diabetes Insipidus. "Treas. of Human Inheritance," 1909, Part I., pp. 1-6, pl. 1.
 Chronic Hereditary Trophœdema. "Treas. of Human Inheritance," 1909, Part I., pp. 32-38, pls. 2.
 Angioneurotic Œdema (Quincke's Disease). "Treas. of Human Inheritance," 1909, Part III., pp. 38-49, pls. 2.
 Hermaphroditism. "Treas. of Human Inheritance," 1909, Part IV., pp. 50-61, pls. 3.
- BULLOCH, W., and PAUL FILDERS. Hæmophilia. "Treas. of Human Inheritance," 1910, Part V., pp. 169-354, pls. 17.
- CANNON, W. B. Bodily Changes in Pain, Hunger, Fear, and Rage. 1916. New York and London: Appleton. Pp. 311, figs. 39.
- CARLISLE, ANTHONY. An Account of a Family having Hands and Feet with Supernumerary Fingers and Toes. *Phil. Trans.*, 1814, civ. 94-101.
- CASTLE, W. E. The Origin of a Polydactylous Race of Guinea-Pigs. *Carnegie Inst. Publ.*, 1906, No. 49, pp. 17-29.
 Genetic Studies of Rabbits and Rats. *Carnegie Inst. Publ.*, 1922, No. 320, pp. 55, pl. 1.
 The Y-Chromosome Type of Sex-Linked Inheritance in Man. *Science*, 1922, lv. 703-4.
- CATON, JOHN DEAN. The Origin of a Small Race of Turkeys. *Amer. Nat.*, 1887, xxi. 350-354.
- COBURN, C. A. Heredity of Wildness and Savageness in Mice. *Behaviour Monographs*, 1922, vol. iv. No. 5, pp. 71.
- COCKAYNE, E. A. A Piebald Family. *Biometrika*, 1914, x. 197-200, pls. 11-18.
- COLE, L. J. Twinning in Cattle, with Special Reference to the Free-martin. *Science*, 1916, xliii. 177.
 Inheritance of Congenital Palsy in Guinea-Pigs. *Amer. Nat.*, 1920, liv. 130-151, figs. 3.
- COMPTON, R. H. A further Contribution to the Study of Right- and Left-Handedness. *Journ. Genetics*, 1912, ii. 53-70.
- CONARD, H. S., and C. B. DAVENPORT. Hereditary Fragility of Bone (Fragilitas osseus, Osteopsathyrosis). Eugenics Rec. Office, Bull. No. 14, 1915, Cold Spring Harbour, pp. 31.
- COOK, O. F. Brachysm, a Hereditary Deformity in Cotton and other Plants. *Journ. Agr. Research*, 1915, iii. 387-400, pls. 10.
- CRAGG, E., and H. DRINKWATER. Hereditary Absence of Phalanges through Five Generations. *Journ. Genetics*, 1916, vi. 81-89, pl. 1.

BIBLIOGRAPHY OF PAPERS CITED 257

- CRAMER, M. Beiträge zur Kenntnis der Polydaktylie und Syndaktylie beim Menschen und einigen Haustieren. *Nov. Acta Abh. k. Leop.-Carol. Deut. Akad. Naturf.*, 1910, xciii. 1-40, pls. 6.
- CREW, F. A. E. Sex-Reversal in Frogs and Toads. A Review of the Recorded Cases of Abnormality of the Reproductive System, and an Account of a Breeding Experiment. *Journ. Genetics*, 1921, xi. 141-181, figs. 34.
- CUNIER, F. Observation curieuse d'une Achromatopsie héréditaire depuis cinq générations. *Annales d'Oculistiques*, 1839, i. 417-420.
- CUSHING, HARVEY. Hereditary Ankylosis of the Proximal Phalangeal Joints (Symphalangism). *Genetics*, 1916, i. 90-106, figs. 11.
- DANFORTH, C. H. Some Notes on a Family with Hereditary Congenital Cataract. *Amer. Journ. Ophthalmol.*, June, 1914, pp. 12, fig. 1.
The Inheritance of Congenital Cataract. *Amer. Nat.*, 1916, l. 442-448.
The Developmental Relations of Brachydactyly in the Domestic Fowl. *Amer. Journ. Anat.*, 1919a, xxv. 97-115, figs. 5.
Evidence that Germ Cells are Subject to Selection on the Basis of their Genetic Potentialities. *Journ. Exptl. Zool.*, 1919b, xxviii. 385-412.
Resemblance and Difference in Twins. *Journ. Hered.*, 1919c, x. 399-409, figs. 14.
A Comparison of the Hands of a Pair of Polydactyl Negro Twins. *Amer. Journ. Phys. Anthropol.*, 1919d, ii. 147-165, figs. 21.
- DARWIN, CHARLES. *Descent of Man*. 1874. Second Edition. Pp. 797, figs. 78.
The Variation of Animals and Plants under Domestication. Second Edition. 2 vols.
- DAVENPORT, C. B. Heredity of Skin Colour in Negro-White Crosses. *Carnegie Inst. Wash. Publ.*, 1913, No. 188, pp. 106, pls. 4.
The Feebly-Inhibited, Nomadism and Temperament Inheritance. *Carnegie Inst. Wash. Publ.*, 1915, No. 236, pp. 158.
The Form of Evolutionary Theory that Modern Genetical Research seems to Favour. *Amer. Nat.*, 1916, l. 449-465.
Heredity of Albinism. *Journ. Hered.*, 1916a, vii. 221-223, figs. 3.

- DAVENPORT, C. B. The Hereditary Factor in Pellagra. *Arch. Internat. Med.*, 1916b, xviii. 4-31.
- Inheritance of Stature. *Genetics*, 1917a, ii. 313-389, figs. 19.
- The Effects of Race Intermingling. *Proc. Amer. Phil. Soc.*, 1917b, lvi. 364-368.
- The Personality, Heredity, and Work of Charles Otis Whitman. *Amer. Nat.*, 1917c, li. 5-30.
- Hereditary Tendency to form Nerve Tumours. *Proc. Nat. Acad. Sci.*, 1918, iv. 213-214.
- A Strain producing Multiple Births. *Journ. Hered.*, 1919, x. 382-384.
- Naval Officers: Their Heredity and Development. *Carnegie Inst. Wash. Publ.*, 1919, No. 289, pp. 236.
- Influence of the Male in the Production of Twins. *Amer. Nat.*, 1920a, liv. 122-129.
- Influence of the Male on the Production of Twins. *Med. Record*, 1920b, March 27.
- Heredity of Constitutional Mental Disorders. *Psych. Bull.*, 1920c, xvii. 300-310.
- Research in Eugenics. *Science*, 1921a, liv. 391-397.
- Comparative Social Traits of Various Races. *School and Society*, 1921b, xiv. 344-346.
- DAVENPORT, G. C. and C. B. Heredity of Skin Pigment in Man. *Amer. Nat.*, 1910, xliv. 641-672, 705-731.
- DEAN, BASHFORD. Albinism, Partial Albinism and Polychromatism in Hag-Fishes. *Amer. Nat.*, 1903, xxxvii. 295-298, figs. 3.
- DETLEFSON, J. A. A Herd of Albino Cattle. *Journ. Hered.*, 1920, xi. 378-9, figs. 2.
- DETLEFSON, J. A., and YAPP, W. W. The Inheritance of Congenital Cataract in Cattle. *Amer. Nat.*, 1920, liv. 277-280.
- DETLEFSON, J. A., and CARMICHAEL, W. J. Inheritance of Syndactylism, Black, and Dilution in Swine. *Journ. Agric. Research*, 1921, xx. 595-604, pl. 1.
- DONCASTER, L. Note on the Inheritance of Characters in which Dominance appears to be influenced by Sex. *Journ. Genetics*, 1911, i. 377-379.
- On Sex-limited Inheritance in Cats, and its Bearing on the Sex-limited Transmission of Certain Human Abnormalities. *Journ. Genetics*, 1913, iii. 11-23.
- DÜNITZ. Sitzungsab. d. Gesells. naturf. Freunde Berlin, 1868, 21-22.

BIBLIOGRAPHY OF PAPERS CITED 259

- DRINKWATER, H. An Account of a Brachydactylous Family. *Proc. Roy. Soc. Edin.*, 1908, xxviii. 35-57, figs. 11.
 The Inheritance of "Thumb-Fingerness" in a Short-Fingered Family. *Mendel Journ.*, 1911, pp. 20, pls. 6, figs. 4.
 Account of a Family showing Minor-Brachydactyly. *Journ. Genetics*, 1912, ii. 21-40, figs. 15.
 Study of a Brachydactylous Family (Minor-Brachydactyly). *Compt. Rend. 4e, Conf. Internat. de Génétique, Paris* (1911), 1913, pp. 549-62, figs. 14.
 Minor-Brachydactyly, No. 2. *Journ. Genetics*, 1914, iii. 217-220, pls. 3.
 Obligatory Bi-manual Synergia with Allocheiria in a Boy otherwise Normal. 17th Internat. Congress Med. London (1913), 1914, pp. 117-124.
 A Second Brachydactylous Family. *Journ. Genetics*, 1915, iv. 323-340, pls. 5, figs. 3.
 Hereditary Abnormal Segmentation of the Index and Middle Fingers. *Journ. Anat. and Physiol.*, 1916, 177-186, figs. 14.
 Inheritance of Artistic and Musical Ability. *Journ. Genetics*, 1916, v. 229-241.
 The Modern Descendants of Dr. Peter Chamberlen. *Liverpool Med.-Chir. Journ.*, 1916, 98-105.
 Phalangeal Anarthrosis (Synostosis, Ankylosis) transmitted through Fourteen Generations. *Proc. Roy. Soc. Med.*, 1917, x. (section Pathology) pp. 60-68, figs. 4.
 The Inheritance of Normal and Pathological Traits in Man. *The Practitioner*, March, 1917, pp. 24. Contains a good list of literature references.
- DUBLIN, LOUIS I. The Mortality of Foreign Race Stocks. *Sci. Monthly*, 1922, xiv. 94-104.
- DUERDEN, J. S. Some Results of Ostrich Investigations. *S. African Journ. Sci.*, November-December, 1918, pp. 38, tables 10, figs. 4, pls. 4.
 Crossing the N. African and S. African Ostrich. *Journ. Genetics*, 1919, viii. 155-198, tables 10, pl. 1, figs. 2.
 Social Anthropology in South Africa: Problems of Race and Nationality. Presidential Address, South African Assoc. for Advancement of Science, 1921, pp. 31.
- DUNCAN, F. N. Orthodactyly. *Journ. Hered.*, 1917, viii. 174-5, figs. 2.
- DWIGHT, TIMOTHY. Travels in New England and New York. 1822. Vol. iii. New Haven.

- EAST, E. M. Hidden Feeble-Mindedness. *Journ. Hered.*, 1917, viii. 215-217.
 Population. *Sci. Monthly*, 1920, xi. 603-624.
 The Agricultural Limits of Our Population. *Sci. Monthly*, 1921, xii. 551-557.
- EAST, E. M., and JONES, D. F. Inbreeding and Outbreeding: Their Genetical and Sociological Significance. 1919. London and Philadelphia: Lippincott. Pp. 285, figs. 46.
- ELBERTON, ETHEL M. On the Inheritance of the Finger Print. *Biometrika*, 1920, xiii. 57-91.
- ENRIQUES, PAOLO. Ricerche sulla eredita della mosche. *Rivista di Biologia*, 1919, i. 72-81.
- ESTABROOK, A. H. The Jukes in 1915. *Carnegie Inst. Wash. Publ.*, 1916, No. 240, pp. 85.
- FACKENHEIM, J. Über einen Fall von hereditärer Polydaktylie mit gleichzeitiger erblicher zahnanomalie. *Jena Zeits. f. Naturw.*, 1888, xxii. 343-385, figs. 7.
- FARABEE, W. C. Inheritance of Digital Malformations in Man. Papers, Peabody Museum, Harvard Univ., 1905, iii. 65-78.
- FAY, EDWARD A. Marriages of the Deaf in America. Volta Bureau, Washington, 1898, pp. 527.
- FERGUSON, G. O. The Mental Status of the American Negro. *Sci. Monthly*, 1921, xii. 533-543.
- FISCHER, EUGEN. Ein Fall von erblicher Haararmut und die Art ihrer Vererbung. *Arch. f. Rass. u. Gesells.-Biol.*, 1910, vii. 50-56.
 Die Rehebother Bastards und das Bastardierungsproblem beim Menschen. 1913. Jena. Pp. 327, pls. 19, figs. 36.
- FISHER, R. A. The Genesis of Twins. *Genetics*, 1919, iv. 489-499.
- FLINDERS-PETRIE, W. M. The Revolutions of Civilization. 1911. London and New York: Harper Bros. Pp. 136, figs. 57.
- FOLKAR, HERBERT H. Nodular Opacity of the Cornea in Three Generations. *Trans. Ophthalmol. Soc.*, 1909, xix. 42-54.
- FRIEDENTHAL, HANS. Das Haarkleid des Menschen. 1908. Berlin: G. Fischer. Pp. 179, pls. 43.
- GALTON, F. Finger Prints. 1892. London: Macmillan. Pp. 216.
- GATES, R. RUGGLES. A Litter of Hybrid Dogs. *Science*, 1909a, xix. 744-747.
 The Stature and Chromosomes of *Cenothera gigas*, De Vries. *Arch. f. Zellforsch.*, 1909b, iii. 525-552.
 The Modification of Characters by Crossing. *Amer. Nat.*, 1915, xlix. 562-569.

BIBLIOGRAPHY OF PAPERS CITED 261

- GATES, R. RUGGLES. Vegetative Segregation in a Hybrid Race. *Journ. Genetics*, 1917, vi. 237-253, pl. 1.
Mutations and Evolution. 1921. London: Wesley and Wheldon. Pp. 118.
- GILPIN, J. BERNARD. An Introduced Species of Nova Scotia. *Trans. N. S. Inst. Sci.*, 1864, i. 60-68.
- GODDART, H. H. The Kallikak Family: A Study in the Heredity of Feeble-mindedness. 1912. New York: Macmillan.
Feeble-mindedness: Its Causes and Consequences. 1914. New York: Macmillan.
Mental Tests and the Immigrant. *Journ. Delinquency*, 1917, ii. 243-278.
- GOLDSMITH, W. M. "The Catlin Mark": The Inheritance of an Unusual Opening in the Parietal Bones. *Journ. Hered.*, 1922, xiii. 69-71, figs. 5.
- GORING, CHAS. On the Inheritance of the Diatheses of Phthisis and Insanity. 1909. London: Dulau. Pp. 28.
- GOSSAGE, A. M. The Inheritance of Certain Human Abnormalities. *Quart. Journ. Med.*, 1908, i. 331-347.
- GOWEN, JOHN W. Identical Twins in Cattle. *Biol. Bull.*, 1922. xlii. 1-6.
- GUYER, M. F., and SMITH, E. A. Studies on Cytolysins—II. Transmission of Induced Eye Defects. *Journ. Exptl. Zool.*, 1920, xxxi. 171-223, pls. 4, figs. 7.
- HADDON, A. C. The Wanderings of Peoples. 1919. Cambridge Press. Pp. 124.
- HAECKER, V. Die Hapsburger Unterlippe. *Verh. d. Deut. Zool. Gesells.*, 1911, 109-113.
Die Familientypus der Hapsburger. *Zeits. f. Abst. u. Vererb.*, 1911, vi. 61-89, figs. 12.
Entwicklungsgeschichtliche Eigenschaftsanalyse (Phänogenetik). 1918. Jena: Fischer. Pp. 344.
- HANKIN, E. H. The Mental Ability of the Quakers. *Sci. Progress*, 1922, xvi. 654-664.
- HANNA, G. DALLAS. Genital Organs of Hermaphroditic Fur Seals. *Amer. Nat.*, 1921, lv. 473-475.
- HANSEN, SØREN. Heredity in the Case of Dementia Præcox and Related Diseases. *Hereditas*, 1922, iii. 114-124.
- HARDY, G. H. Mendelian Proportions in a Mixed Population. *Science*, 1908, xxviii. 49-50.
- HARMAN, N. A Study in Heredity. Six Generations of Piebalds. *Trans. Ophthalmol. Soc.*, 1909, xxix. 25-33.

- HARMAN, N. BISHOP. Congenital Cataract: A Pedigree of Five Generations. *Trans. Ophthalmol. Soc.*, 1909, xxix. 101-108.
Congenital Cataract. "Treas. Human Inheritance," 1910, Part IV., pp. 126-166, pls. 8.
- HAWKES, ONERA A. MERRITT. On the Relative Lengths of the First and Second Toes of the Human Foot, from the Point of View of Occurrence, Anatomy, and Heredity. *Journ. Genetics*, 1914, iii. 249-274, pls. 3, figs. 6.
- HAYDEN, C. C. A Case of Twinning in Dairy Cattle. *Journ. Hered.*, 1922, xiii. 22-24, figs. 4.
- HOFFMAN, H. Die Nachkommenschaft bei endogenen Psychosen. 1921. Berlin: Springer. Pp. 233, figs. 43.
- HOLMES, S. J. The Trend of the Race. 1921. London: Constable. Pp. 396.
- HOLMES, S. J., and SCHOFIELD, R. O. Inheritance of White Forelock. *Journ. Hered.*, 1917, viii. 359-360, fig. 1.
- HOOPER, J. J. A Peculiar Breed of Goats. *Science*, 1916, xliii. 571.
- HOPE, W. B., and FRENCH, HERBERT. Persistent Hereditary Oedema of the Legs with Acute Exacerbations. Milroy's Disease. *Quart. Journ. Med.*, 1908, i. 312-330, pls. 2.
- HORNE, JOBSON. Deaf-mutism. "Treas. Human Inheritance," 1909, pp. 27-29, pl. 1; pp. 69-72, pls. 2; pp. 124-126, pl. 1.
- HOVER, J. M. Finding the Prepotent Sire. *Journ. Hered.*, 1916, vii. 173-178.
- HOWE, FREELAND, Jnr. A Case of Abnormality in Cat's Paws. *Amer. Nat.*, 1902, xxxvi. 511-526, figs. 18.
- HOWE, LUCIEN. A Bibliography of Hereditary Eye Defects. Eugenics Record Office, Bull. No. 21, 1921, pp. 45.
- HUDDART, JOSEPH. An Account of Persons who could not Distinguish Colours. *Phil. Trans.*, 1777, lxvii. 260-265.
- HUMPHREYS, COL. DAVID. On a New Variety in the Breeds of Sheep. *Phil. Trans.*, 1813, 88-95.
- HUNTER, JOHN. Account of the Free-martin. *Phil. Trans.*, 1779, lxix. 279-293.
- HURLIN, RALPH, G. A Case of Inherited Syndactyly in Man. *Journ. Hered.*, 1921, xi. 334-5, figs. 2.
- HURST, C. C. Mendelian Characters in Plants, Animals, and Man. *Verh. Naturf. Vereines in Brünn.*, 1911, xlix. 1-22.
Mendelian Heredity in Man. *Eugenics Review*, 1912, pp. 25, figs. 6.

BIBLIOGRAPHY OF PAPERS CITED 263

- HUXLEY, JULIAN S. Some Recent Advances in the Biological Theory of Sex. *Journ. Roy. Soc. Arts*, 1922, lxx. 206-217.
- JENKS, A. E. Pitted Ear-Lobes of Congenital Origin. *Journ. Hered.*, 1916, vii. 553-4, figs. 7.
- JENNINGS, H. S. The Numerical Results of Diverse Systems of Breeding. *Genetics*, 1916, i. 53-89.
- JONES, D. F., and MASON, S. L. Inheritance of Congenital Cataract. *Amer. Nat.*, 1916a, l. 119-126.
Further Remarks on the Inheritance of Congenital Cataract. *Amer. Nat.*, 1916b, l. 751-757.
- JONES, F. S., and ARNOLD, J. F. Stagers in Sheep in Patagonia. *Journ. Exp. Med.*, 1917, xxvi. 805-823, pls. 4.
- JORDAN, D. S. The Inbred Descendants of Charlemagne: A Glance at the Scientific Side of Genealogy. *Sci. Monthly*, 1921, xiii. 481-492.
- JORDAN, H. E. A Comparative Microscopic Study of the Melanin Content of Pigmented Skins, with Special Reference to the Question of Colour Inheritance among Mulattoes. *Amer. Nat.*, 1911, xlv. 449-470, figs. 3.
- KEITH, Sir A. The Differentiation of Mankind into Racial Types. Rept. British Assoc., Bournemouth, 1920, pp. 275-281.
The Evolution of Human Races in the Light of the Hormone Theory. *Johns Hopkins Hosp. Bull.*, 1922, xxxiii. 155-159, 195-201.
- KEMPF, EDWARD J. Psychopathology. 1921. London: Henry Kimpton. Pp. 762, figs. 87.
- KEMPTON, J. H. A Brachytic Variation in Maize. Bull. No. 925, 1921, U.S. Dept. Agric., pp. 28, pls. 19, figs. 8.
- KENNEL, J. Ueber eine stummelschwänzige Hauskatze und ihre Nachkommenschaft. *Zool. Jahrb. (Syst.)*, 1901, xv. 219-242, figs. 2.
- KEY, WILHELMINE E. Heredity and Social Fitness: A Study of Differential Mating in a Pennsylvania Family. *Carnegie Inst. Wash. Publ.*, 1920, No. 296, pp. 102.
- KINDRED, J. E. Inheritance of a Pit in the Skin of the Left Ear. *Journ. Hered.*, 1922, xii. 336-7, fig. 1.
- KOCH, MATHILDA L., and RIDDLE, OSCAR. The Chemical Composition of the Brain of Normal and Ataxic (?) Pigeons. *Amer. Journ. Physiol.*, 1918, xlvii. 124-136.
- KRETSCHNER, E. Körperbau und Charakter. 1922. Berlin: Springer.

- KÜHN, JULIUS. Die Stammväter unserer Hunde-Rassen. 1877. Vienna.
- LANE, W. C. Hereditary Nose-Bleed. *Journ. Hered.*, 1916, vii. 132-134, fig. 1.
- LAUGHLIN, H. H. Calculating Ancestral Influence in Man: A Mathematical Measure of the Facts of Bisexual Heredity. *Genetics*, 1920, v. 435-458.
- LAWRENCE, T. W. P. True Hermaphroditism in the Human Subject. *Trans. Path. Soc. Lond.*, 1906, lvii. 21-24, figs. 2.
- LEARMONTH, J. R. The Inheritance of Specific Isoagglutinins in Human Blood. *Journ. Genetics*, 1920, x. 141-148.
- LENZ, FRITZ. Über die krankhaften Erbanlagen des Mannes und die Bestimmung des Geschlechts beim Menschen. 1912. Jena: Fischer. Pp. 170, figs. 23.
- LEWIS, T. Hereditary Malformations of the Hands and Feet, "Treas. Human Inheritance," 1909a, Part I., pp. 6-10. pls. 3.
Polydactylism. "Treas. Human Inheritance," 1909b, Part I., pp. 10-14, pls. 2.
Brachydactylism. "Treas. Human Inheritance," 1909c, Part I., pp. 14-17, pls. 3.
- LEWIS, T., and EMBLETON, D. Split-Hand and Split-Foot Deformities, their Types, Origin, and Transmission. *Biometrika*, 1908, vi. 26-58, pls. 7.
- LILLIE, F. R. The Free-martin: A Study of the Action of Sex Hormones in the Fœtal Life of Cattle. *Journ. Exptl. Zool.*, 1917, xxiii. 371-422.
- LITTLE, C. C. Some Factors influencing the Human Sex-Ratio. *Proc. Soc. Exptl. Biol. and Med.*, 1919, xvi. 127-130.
A Note on the Origin of Piebald Spotting in Dogs. *Journ. Hered.*, 1920, xi. 12-15, figs. 3.
Inheritance of a Predisposition to Cancer in Man. Abstracts of Papers, Second Eugenics Congress, New York, 1921, pp. 22.
- LITTLE, C. C., and GIBBONS, M. Evidence for Sex-Linked Lethal Factors in Man. *Proc. Soc. Exp. Biol. and Med.*, 1921, xviii. 111-115.
- LOEB, LEO. Inheritance of Cancer in Mice. *Amer. Nat.*, 1921, lv. 510-528.
- LOISEL, G. Les Chats anoures de l'île de Man. *Bull. Mus. d'Hist. Nat.*, 1907, 185-192.

BIBLIOGRAPHY OF PAPERS CITED 265

- LORT, REV. MICHAEL. An Account of a Remarkable Imperfection of Sight. In a letter from J. Scott to the Rev. Mr. Whisson, of Trinity College, Cambridge. *Phil. Trans.*, 1779, lxxviii. 611-614.
- LOVE, A. G., and DAVENPORT, C. B. A Comparison of White and Coloured Troops in Respect to Incidence of Disease. *Proc. Nat. Acad. Sci.*, 1919, v. 58-67.
- LOVE, J. K. The Origin of Sporadic Congenital Deafness. *Journ. Laryngol., Rhinol., and Otol.*, 1920, xxxv. 263-270.
- LUCE, L. H. and W. H. Three Cases of Hypospadias in which the Sex was Undeterminable until Puberty. *Amer. Nat.*, 1890, xxiv. 1016-1019.
- LUNDBORG, H. Medizinisch-biologische Familienforschungen innerhalb eines 232-köpfigen Bauerngeschlechtes in Schweden (Provinz Blekinge). 1913. Jena: Fischer. 2 Vols. Vol. i. pp. 519+220; vol. ii. 10 pls., 52 charts. Svenska Folktyper. 1919. Stockholm: Hasse u. Tullbergs Boktryckeri.
- Arv och miljö. Befolkingspolitiska synpunkter. *Det nya Sverige*, 1920, xiv. 3-12.
- Hereditary Transmission of Genotypical Deaf-mutism. *Hereditas*, 1920, i. 35-40.
- Hybrid Types of the Human Race. *Journ. Hered.*, 1921, xii. 274-280, figs. 4.
- LUSH, J. L. An Hereditary Notch in the Ears of Jersey Cattle. *Journ. Hered.*, 1922, xiii. 8-13, figs. 8.
- LYNCH, CLARA J. Short Ears an Autosomal Mutation in the House-Mouse. *Amer. Nat.*, 1921, lv. 421-426, fig. 1.
- MACBRIDE, E. W. The Study of Heredity, Part IV. *Eugenics Review*, January, 1917, pp. 28, figs. 5.
- MACCAUGHEY, VAUGHAN. Race Mixture in Hawaii. *Journ. Hered.*, 1919, x. 41-47, 90-95.
- MACDONALD, JAMES, and SINCLAIR, JAMES. History of Polled Aberdeen or Angus Cattle. 1882. Edinburgh and London: Blackwood. Pp. 459, illustrated.
- MACHIN, JOHN. An Extract from the Minutes of the Royal Society, March 16, 1731, containing an Uncommon Case of a Distempered Skin. *Phil. Trans.*, 1733, xxxvii. 299-301, figs. 3.
- MACKINDER, D. Deficiency of Fingers transmitted through Six Generations. *British Med. Journ.*, 1857, 845-6.
- MANSON, J. S. Hereditary Syndactylism and Polydactylism. *Journ. Genetics*, 1915, v. 51-63, pls. 6.

- MARTIN, P. J. Case of Hereditary Ichthyosis. *Med.-Chirurg. Trans.*, 1818, ix. 52-55, pls. 2.
- MARTINS, F. Konstitution und Vererbung in ihrer Beziehungen zur Pathologie. 1914. Berlin: Springer. Pp. 258, figs. 13.
- MAYNARD, C. D. Note on a Negro Piebald. *Biometrika*, 1914, x. 193, pls. 10.
- MCDUGAL, W. Psychology, the Study of Behaviour. 1919. London: Williams and Norgate. Pp. 251.
- McMULLEN, GEO., and PEARSON, K. On the Inheritance of the Deformity known as Split-Foot or Lobster Claw. *Biometrika*, 1913, ix. 381-390, pls. 6.
- METCHNIKOFF, E. The Nature of Man. 1903. New York and London: Putnams. Pp. 309, figs. 20.
- MEULENGRACHT, E. Der chronische hereditäre hämolytische Ikterus. 1922. Leipzig: W. Klinkhardt.
- MILLER, NEWTON. Heredity of White Forelock. *Journ. Hered.*, 1915, lxi. 165-169, figs. 4.
- MILROY, W. F. An Undescribed Variety of Hereditary Œdema. *New York Med. Journ.*, 1892, lvi. 505-508.
- MIVART, ST. GEORGE. A Monograph of the Canidæ. 1890. London: R. H. Porter. Pp. 216, 45 coloured plates, figs. 59.
- MJOEN, JON ALFRED. Harmonic and Unharmonic Crossings. *Eugenics Review*, 1922, xiv. 35-40.
- MOHR, OTTO L. A Case of Hereditary Brachyphalangy utilized as Evidence in Forensic Medicine. *Hereditas*, 1921, ii. 290-298, figs. 10.
- MOHR, OTTO, and WRIEDT, CHR. A New Type of Hereditary Brachyphalangy in Man. *Carnegie Inst. Wash. Publ.*, 1919, No. 295, pp. 64, pls. 7.
- NETTLESHIP, E. A History of Congenital Stationary Night-Blindness in Nine Consecutive Generations. *Trans. Ophthalmol. Soc.*, 1907, xxvii.
- A Pedigree of Congenital Night-Blindness with Myopia. *Trans. Ophthalmol. Soc.*, 1912, xxxii.
- NEWMAN, H. H. Night-Blindness. *Journ. Genetics*, 1913, iii. 25-38, figs. 2.
- Hereditary and Organic Symmetry in Armadillo Quadruplets. *Biol. Bull.*, 1916, xxix. 1-32, figs. 16; xxx. 173-209, figs. 19.
- The Biology of Twins. 1917. University of Chicago Press.
- The Experimental Production of Twins and Double Monsters in the Larvæ of the Starfish *Patiria miniata*, together with a Discussion of the Causes of Twinning in General. *Journ. Exper. Zool.*, 1921, xxxiii. 321-352, figs. 46.

BIBLIOGRAPHY OF PAPERS CITED 267

- NEWMAN, H. H., and PATTERSON, J. T. The Limits of Hereditary Control in Armadillo Quadruplets: A Study of Blastogenic Variation. *Journ. Morph.*, 1911, xxii. 855-926, figs. 24.
- NILSSON, MARTIN P. The Race Problem of the Roman Empire. *Hereditas*, 1921, ii. 370-390.
- ORDAHL, GEORGE. Heredity of Feeble-mindedness. *Training School Bull.*, March-April, 1919, pp. 2-16.
- OSBORN, DOROTHY. Inheritance of Baldness. *Journ. Hered.*, 1916, vii. 347-355, figs. 9.
- OSBORN, H. L. A Case of Polydactylism. *Amer. Nat.*, 1900, xxxiv. 681-2, figs. 4.
- OTIS, ARTHUR S. Heredity and Mental Defect. *Journ. Delinquency*, May, July, 1916, pp. 87-100, 125-128.
- PAINTER, T. S. The Y-Chromosome in Mammals. *Science*, 1921, liii. 503-4.
The Sex Chromosomes of the Monkey. *Science*, 1922, lxvi. 286-7, figs. 4.
- PATTERSON, J. T. Polyembryonic Development in *Tatusia novemcincta*. *Journ. Morph.*, 1913, xxiv. 560-662, pls. 11, figs. 84.
- PEARL, M. D., and PEARL, R. On the Relation of Race-Crossing to the Sex Ratio. *Biol. Bull.*, 1908, xv. 194-205.
- PEARL, R. A Case of Triplet Calves, with some General Considerations regarding Multiple Gestation in normally Uniparous Animals. *Ann. Rept. Maine Agr. Expt. Sta.*, 1912, 259-282, figs 2.
- PEARL, R. A Contribution towards an Analysis of the Problem of Inbreeding. *Amer. Nat.*, 1913, xlvii. 577-614.
On the Results of Inbreeding a Mendelian Population: A Correction and Extension of Previous Conclusions. *Amer. Nat.*, 1914a, xlviii. 57-62.
Inbreeding and Relationship Coefficients. *Amer. Nat.*, 1914b, xlviii. 513-523.
Certain Evolutionary Aspects of Human Mortality Rates. *Amer. Nat.*, 1920, liv. 5-44.
A Biological Classification of the Causes of Death. *Metron*, 1921, i. 92-99.
The Biology of Death. *Sci. Monthly*, 1921.
- PEARL, R., and PARSHLEY, H. M. Data on the Sex Determination in Cattle. *Biol. Bull.*, 1913, xxiv. 205-225.
- PEARL, R., and REED, L. J. On the Rate of Growth of the Population of the United States since 1790, and its Mathematical Representation. *Proc. Nat. Acad. Sci.*, 1920, vi. 275-288.

- PEARL, R. and SALAMAN, R. N. The Relative Time of Fertilisation of the Ovum and the Sex Ratio amongst Jews. *Amer. Anthropol.*, 1913, xv. 668-674.
- PEARSON, K. On a Generalised Theory of Alternative Inheritance, with Special Reference to Mendel's Laws. *Phil. Trans. Roy. Soc.*, 1904, A. 203, 53-86.
- On the Inheritance of the Mental and Moral Characters in Man, and Its Comparison with the Inheritance of the Physical Characters. *Biometrika*, 1904, iii. 131-190.
- A First Study of the Statistics of Pulmonary Tuberculosis. 1907. London: Dulau. Pp. 26.
- On Inheritance of the Deformity known as Split-Foot or Lobster Claw. *Biometrika*, 1908, vi. 69-79, pls. 9.
- Notes on the Skin Colour of the Crosses between Negro and White. *Biometrika*, 1909, vi. 348-353.
- Tuberculosis, Heredity and Environment. 1912. London: Dulau. Pp. 46.
- Note on the Honduras Piebald. *Biometrika*, 1913, ix. 330-331, pls. 4.
- Life, Letters, and Labours of Sir Francis Galton. 1914. Cambridge University Press. Pp. ix+246, pls. 66.
- Inheritance of Psychical Characters. *Biometrika*, 1919, xii. 367-372.
- A New White-Lock Family (Barton's Case). *Biometrika*, 1921, xiii. 347-349, pls. 2.
- PEARSON, K., NETTLESHIP, and USHER. A Monograph on Albinism in Man. 1913. Drapers' Company Research Memoirs. Cambridge University Press. In 4 parts.
- PELL, C. E. The Law of Births and Deaths. 1912. London: Fisher Unwin. Pp. 192.
- POPENOE, PAUL. Concerning Prepotency. *Journ. Hered.*, 1916, vii. 331-336, fig. 1.
- Heredity and the Mind. *Journ. Hered.*, 1916, vii. 456-462.
- Twins Reared Apart. *Journ. Hered.*, 1922, xiii. 142-144, fig. 1.
- PRIESTLEY, Rev. JOSEPH. An Account of Persons who could not distinguish Colours. By Mr. Joseph Huddart, in a Letter to the Rev. Joseph Priestley, LL.D., F.R.S. *Phil. Trans. Roy. Soc. Lond.*, 1777, lxvii. 260-265.
- PUNNETT, R. C. Eliminating Feeble-mindedness. *Journ. Hered.*, 1917, viii. 464-5.
- PUNNETT, R. C., and BAILEY, P. G. On Inheritance of Weight in Poultry. *Journ. Genetics*, 1914, iv. 23-39, figs. 3, pl. 1.
- Genetic Studies in Rabbits. I. On the Inheritance of Weight. *Journ. Genetics*, 1918, viii. 1-25, figs. 12.

BIBLIOGRAPHY OF PAPERS CITED 269

- RAMALAY, F. Inheritance of Left-Handedness. *Amer. Nat.*, 1913, xlvii. 730-738.
- RIDDLE, O. The Determination of Sex and Its Experimental Control. *Bull. Amer. Acad. Med.*, 1914, xv. 1-20.
The Control of the Sex Ratio. *Journ. Wash. Acad. Sci.*, 1917, vii. 319-356.
A Demonstration of the Origin of two Pairs of Female Identical Twins from Two Ova of High Storage Metabolism. *Journ. Exptl. Zool.*, 1918, xxvi. 227-254.
A Case of Hereditary Ataxia (?) in Pigeons. *Proc. Soc. Exptl. Biol. and Med.*, 1918, xv. 56-7.
- RIEDER, H. Ueber gleichzeitiges Vorkommen von Brachy- und Hyper-phalangie an der Hand. *Deutsch. Arch. Klin. Med.*, 1899, lxvi. 330-348, figs. 6.
- RISCHBIETH, H. Hare-Lip and Cleft Palate. "Treas. Human Inheritance," 1910, Part IV., pp. 79-123, pls. 8.
- RISCHBIETH, H., and BARRINGTON, AMY. Dwarfism. "Treas. Human Inheritance," 1912, Part. VII., pp. 355-573, pls. 35.
- RITZMAN, E. G. Mendelism of Short Ears in Sheep. *Journ. Agric. Research*, 1916, vi. 797-8.
Breeding Earless Sheep. *Journ. Hered.*, 1921, xi. 238-240, figs. 4.
- ROBERTS, ELMER. Polydactylism in Cattle. *Journ. Hered.*, 1921, xii. 84-86, figs. 5.
- RÜDIN, ERNST. Studien über Vererbung und Entstehung geistiger Störungen. I. Zur Vererbung und Neuentstehung der Dementia Præcox. 1916. Berlin: J. Springer. Pp. 172, figs. 66.
- SALAMAN, R. N. Heredity and the Jew. *Journ. Genetics*, 1911, i. 273-292, pls. 4, figs. 6.
- SANO, F. The Convolutional Pattern of the Brains of Identical Twins: A Study of Hereditary Resemblance in the Furrows of the Cerebral Hemispheres. *Phil. Trans. Roy. Soc.*, 1915, B. 208, 37-61, figs. 5.
- SCHMIDT, JOHS. The Genetic Behaviour of a Secondary Sexual Character. *Compt. Rend. Trav. Lab. Carlsberg*, 1920, vol. xiv. No. 8, pp. 12, pls. 5.
- SCHOFIELD, R. Inheritance of a Bilobed Ear. *Journ. Hered.*, 1917, viii. 517-8, figs: 2.
Inheritance of Webbed Toes. *Journ. Hered.*, 1922, xii. 400-1.
- SCHROEDER. Entstehung und Vererbung von Missbildungen an der Hand eines Hypodactyliestammbaumes. *Monatsschr. Geburtshilfe Gynäkol.*, 1918, xlvi. 210-222, pls. 3, figs. 7. (From *Bot. Abstr.*, x. 86, 1922.)

- SCHULTZ, A. H. Zygodactyly and its Inheritance. *Journ. Hered.*, 1922, xiii. 113-117, figs. 7.
- SCHUSTER, EDGAR, and ELDERTON, ETHEL. The Inheritance of Mental Ability. Galton Laboratory Memoirs—I. 1907.
- SEASHORE, C. E. The Inheritance of Musical Talent. *Musical Quarterly*, 1920, vi. 586-598.
- SEDGWICK, WILLIAM. On Sexual Limitation in Hereditary Disease. *Brit. and Foreign Med.-Chirurg. Review*, 1861, xxvii. 477-489; xxviii. 198-214.
On the Influence of Sex in Hereditary Disease. *Brit. and Foreign Med.-Chirurg. Review*, 1863, xxxi. 445-478; xxxii. 159-197.
- SELIGMAN, C. G. A Note on Albinism, with Special Reference to its Racial Characteristics among Melanesians and Polynesians. *Lancet*, September 20, 1902, figs. 4.
Congenital Cretinism in Calves. *Trans. Path. Soc. Lond.*, 1904, lv. 1-20, figs. 6.
- SESSIONS, MINA A. Feeble-minded in Ohio. *Journ. Hered.*, 1917, viii. 291-298, figs. 5.
- SHATTOCK, S. G., and SELIGMAN, C. G. An Example of True Hermaphroditism in the Domestic Fowl, with Remarks on the Phenomenon of Allopterotism. *Trans. Path. Soc. Lond.*, 1906, lvii. 69-109, figs. 9, pl. 1.
- SIEMENS, H. W. Einführung in die allgemeine Konstitutions- und Vererbungs-pathologie. 1921. Berlin: Springer. Pp. 229, figs. 80.
- SIMPSON, Q. I., and CASTLE, W. E. A Family of Spotted Negroes, *Amer. Nat.*, 1913, xlvii. 50-56, figs. 4.
- SPILLMAN, W. J. History and Peculiarities of the Mule-Foot Hog. *Amer. Breeders' Mag.*, 1910, v. 178-182.
- STANDLEY, PAUL C. Albinism in the Black Bear. *Science*, 1921, liv. 74.
- STANNUS, H. S. Anomalies of Pigmentation among Natives of Nyasaland. *Biometrika*, 1913, ix. 333-365, pls. 10.
Congenital Anomalies in a Native African Race. *Biometrika*, 1914, x. 1-24, pls. 6.
- STANTON, HAZEL M. The Inheritance of Specific Musical Capacities. Eugenics Record Office, Bull. No. 22, 1922 (from *Psych. Monographs*, Princeton, xxxi. 157-204).
- STIEVE, H. Über Hyperphalangiè des Daumens. *Anat. Anz.*, 1916, xlviii. 565-581, fig. 1.
- ST. JOHN, HAROLD. Sable Island, with a Catalogue of its Vascular Plants. *Proc. Boston Nat. Hist. Soc.*, 1921, xxxvi. 1-103, pls. 2.

BIBLIOGRAPHY OF PAPERS CITED 271

- STOCKARD, C. R. The Artificial Production of Cyclopean Monsters. *Journ. Exptl. Zool.*, 1909, vi.
 A Probable Explanation of Polyembryony in the Armadillo. *Amer. Nat.*, 1921, lv. 62-68.
- STORER, REV. JOHN. The Wild White Cattle of Great Britain (New Edition). 1881. London. Pp. 384, figs. 12.
- STUCKEY, H. P. The Slit-Eyed People. *Journ. Hered.*, 1916, vii. 147, pl. 1.
- SULLIVAN, LOUIS R. The "Samar" United Twins. *Amer. Journ. Phys. Anthropol.*, 1919, ii. 21-24, pl. 1.
- SUMNER, F. B. Heredity, Environment, and Responsibility. Bull. 10, Scripps Inst. for Biol. Research, 1921, pp. 12.
 The Organism and its Environment. *Scientific Monthly*, March, 1922, pp. 223-233.
- SUMNER, F. B., and HUESTIS, R. R. Bilateral Asymmetry in its Relation to Certain Problems of Genetics. *Genetics*, 1921, vi. 445-485, figs. 5.
- SWINGLE, W. W. Is there a Transformation of Sex in Frogs? *Amer. Nat.*, 1922, lvi. 193-210, pls. 2, figs. 2.
- TERMAN, L. M. Adventures in Stupidity—A Partial Analysis of the Intellectual Inferiority of a College Student. *Sci. Monthly*, 1922, xiv. 24-40.
- THADANI, K.T. A Toothless Type of Man. *Journ. Hered.*, 1921, xii. 87-8.
- TUPPER, W. W., and BARTLETT, H. H. A Comparison of the Wood Structure of *Cenothera stenomeris* and its Tetraploid Mutation *gigas*. *Genetics*, 1916, i. 177-184.
- UHLENHUTH, E. Experimental Production of Gigantism by feeding the Anterior Lobe of Hypophysis. *Journ. Genl. Physiol.*, 1921, iii. 347-365.
 The Effect of Iodine and Iodothyron on the Larvæ of Salamanders—III. The Rôle of the Iodine in the Specific Action of the Thyroid Hormone as tested in the Metamorphosis of the Axolotl Larvæ. *Biol. Bull.*, 1922, xlii. 143-152, figs. 3.
- URQUHART, A. R. Insanity. "Treas. Human Inheritance," 1909, Part III., pp. 61-69, pls. 2.
- USHER, C. H. Histological Examination of an Adult Human Albino's Eyeball, with a Note on Mesoblastic Pigmentation in Fœtal Eyes. *Biometrika*, 1920, xiii. 46-56, pls. 2.
- VON WINIWARTER, H. Études sur la spermatogenèse humaine *Arch. de Biol.*, 1912, xxvii. 91-189, pls. 6-7.
- WARREN, HOWARD C. Numerical Effects of Natural Selection acting upon Mendelian Characters. *Genetics*, 1917, ii. 305-312

- WEGELIN, CARL. Über eine erbliche Missbildung des kleinen Fingers. *Berlin Klin. Wochenschr.*, 1917, liv. No. 12; *Review Zeits. f. Abst. u. Vererb.*, 1919, xx. 159.
- WHITEHOUSE, HERBERT. A Diagnosis of Degeneracy from Conditions revealed by a Field Study of Green Lake County (Wisconsin). *Journ. Amer. Law and Criminology*, May, 1918, pp. 47-79.
- WIEMAN, H. L. Chromosomes in Man. *Amer. Journ. Anat.*, 1913, xiv. 461-471, figs. 10.
The Chromosomes of Human Spermatocytes. *Amer. Journ. Anat.*, 1917, xxi. 1-21, pls. 4.
- WILDER, H. H. Duplicate Twins and Double Monsters. *Amer. Journ. Anat.*, 1904, iii. 387-472.
Palm and Sole Studies. *Biol. Bull.*, 1916, xxx. 135-172, 211-252, figs. 42.
- WINDLE, C. A. Teratological Evidence as to the Heredity of Acquired Conditions. *Journ. Linn. Soc., Zool.*, 1891, xxiii. 448-502.
A Note on Identical Malformations in Twins. *Journ. Anat. and Physiol.*, 1892, xxvi. 295-299.
- WINGE, Ö. On a Partial Sex-linked Inheritance of Eye Colour in Man. *Compt. Rend. Lab. Carlsberg*, 1921, vol. xiv. No. 12, pp. 23.
- WITSCHI, EMIL. Development of Gonads and Transformation of Sex in the Frog. *Amer. Nat.*, 1921, lv. 529-538, figs. 7.
- WOODS, F. A. What is there in Physiognomy? *Journ. Hered.*, 1922, xii. 301-318, figs. 7.
- WRIEDT, CHR. Albinisme i hester. Borket, hvitborket og gule. *Tidsskr. Norske Landbr.*, 1918, 396-406.
Über die Vererbung von Ohrenlänge beim Schafe. *Zeitschr. f. Abst. u. Vererb.*, 1919, xx. 262-3.
Breeding Earless Sheep. *Journ. Hered.*, 1921, xii. 56.
- WRIGHT, SEWALL. On the Nature of Size Factors. *Genetics*, 1918, iii. 367-374.
- WRIGHT, SEWALL, and LEWIS, PAUL A. Factors in the Resistance of Guinea-Pigs to Tuberculosis, with Special Regard to Inbreeding and Heredity. *Amer. Nat.*, 1921, lv. 20-50.
- YEARSLEY, MACLEOD. Can Acquired Deafness lead to Congenital Deafness? *Journ. Laryngol., Rhinol., and Otol.*, 1920, xxxv. 270-1.
- YERKES, R. M. The Heredity of Wildness and Savageness in Rats. *Journ. An. Behaviour*, 1913, iii. 286-296.
- ZELENY, CHARLES. The Relative Numbers of Twins and Triplets. *Science*, 1921, liii. 262-3.

INDEX

A

- ABERYSTWITH**, 101
Abietineæ, polyembryony in, 179
Ability, and brain, 234
 inheritance of, 145, 147, 148, 170, 222
Abnormal segmentation of fingers, 85
Abnormalities, inheritance of, 75, 76, 106, 116, 125, 127, 129, 142, 158, 174
 occurrence of, 93, 204
Abortions in primitive races, 241
Absence of external ear, 133, 134
 of patella, 136
Acanthosicyos horrida, 227
Achondroplasia, 34, 35, 39, 40, 126, 215
Acromegaly, 211, 216
Addison's disease, 212
Adkinson, June, 138
Adrenal capsules. See **Supra-renal capsules**
Adrenalin, 217, 218, 220
Agriculture, 241, 242
Ailments of twins, 188
Aino of Japan, 54
Albert, Henry, 93
Albinos, eyeballs of, 44
Albinism, change in hereditary behaviour of, 70
 frequency of, 65
 in animals, 68
 in cattle, 69
 in guinea-pigs, 125
 inheritance of, 57, 67, 110
 in horses, 71
 in rabbits, 125
Albinotics, 58, 65, 68
Alcohol, effect on germ cells, 92
Alcoholism, 142, 149, 153, 235
Alexander, 103
Alkaptonuria, 110
Allelomorphs, multiple, 27
Alpine race, 212, 231
Amaurosis, 117, 120, 142, 158
Amblystoma, 41
American army intelligence tests, 234
Americans in crosses, 230
Amerindians, 101
Amphibians, hermaphrodites in, 133
Amphioxus, 210
Analysis of the mind, 146
Ancestral inheritance in man, 209
Ancon sheep, 40
Anencephali, 193
Angioneurotic oedema, 127
Angora hair, in guinea-pigs, 15
 in other animals, 125
Animal behaviour, 165
Aniridia, 116, 120, 130
Anodont condition, 71
Anthropoid apes, behaviour of, 165
 hormones in, 217
Antibody, 144
Antisocial behaviour, 163
Apache Indians, left-handedness in, 72
Apes, placenta of, 178
Apogamy, 209
Apprenticeships, 244
Arable land in the United States, 245
Arabs, polydactyly in, 101
Arboreal ancestry of man, 178
Arctomys, 68
Arey, L. B., 199
Argentine, crosses in, 230
Aristocratic society, 221
Aristotle, 98
Arizona, 39, 65
Armadillo, scutes of, 181, 191
 young of, 176, 177, 178, 181, 182, 199, 200
Arrested development, 89, 154
Arsenic, in thyroxin, 214
Artificial selection, 175

- Artistic ability, inheritance of, 170
 evolution of, 247
 Assortative mating, 139, 208
 Asthma, inheritance of, 138, 188
 Astigmatism, inheritance of, 116
 Ataxia, in pigeons, 109, 167
 Ateliosis, 34, 35, 39
 Atrichosis, 56
 Atwood, E. S., 101
 Aurignatian man, 247
 Australian aborigines, mentality
 of, 225
 stature of, 28
 Austria, albinos in, 65
 Austrians in crosses, 230
 Autonomic bodily functions, 166
 Auximones, 42
- B
- Bach family, 170
 Bailey, P. G., 31
 Baker, Henry, 121
 Balanced lethal factors, 209
 Baldness, inheritance of, 25
 Baldwin, 73
 Ballowitz, E., 101, 103, 104
 Banta, A. M., 132
 Bantams, silver seabright, 31
 Bantus, abnormalities in, 71
 crosses with Boers, 228
 Barfurth, 96
 Barrington, Amy, 34
 Bartlett, H. H., 42
 Bateson, W., 75, 84, 95, 97, 98,
 110, 113, 115, 124, 205
 Bauhin, 131
Beagle voyage, 169
 Bean, R. B., 53
 Beans, bush varieties, 35
 pure lines in, 221
 Bear, albino, 69
 Beavers, albino, 68
 Beeley, A. L., 72, 73, 74
 Behaviourism, 165
 Belgium, population in, 243
 Bergen, Norway, 48
 Bergman, E., 108
 Beri-beri, 42
 Berman, Louis, 215, 218, 219
 Bermuda, 52
 Bernstein, C., 133
 Bilateral asymmetry, inheritance
 of, 191
 Bimanual synergia, 136
 Binet-Simon tests, 146, 149, 154,
 232, 234
 Biobled ear, inheritance of, 135
 Biometry, 9
 Biovular twins, 191. See Twins
 Bipinnaria larva, 179
 embryology of, 177
 Birds, eye colours in, 50, 51
 Birth-rates, 205, 237, 238, 239,
 240, 244
 Blacker and Lawrence, 131
 Blastocyst, of armadillo, 177
 of deer, 178
 Blastogenic variation, 181
 Blazek twins, 179
 Bleeders. See Hæmophilia
 Blending inheritance, 167, 213,
 223
 Blindness, hereditary. See Amau-
 rosis
 Blood system, peculiarities in, 137
 Blood transfusion, 129
 Blue eyes in Nordic race, 212
 inheritance of, 45
 in the tropics, 207
 sclerotics, inheritance of, 142
 Boas, H. M., 44
 Boas, J. E. V., 96
 Bodily effects of anger, 218
 Boers, crosses of, 229
 Bohemia, 179
 Bokhara, sheep of, 135
 Boleyn, Anne, 101, 102
 Bollenbach family, 55
 Bonavia, E., 93
 Bond, C. J., 49, 50, 54, 95
 Bonnevie, K., 96, 194
 Borneo, 103
 Boston, 39, 40
 Bottomley, W. B., 42
 Bovidae, 224
 Bowditch, H., 113
 Brachycephalic skulls, 212
 Brachycephaly, proöpic, 126, 216
 Brachyductyly, 9, 10, 11, 12, 75,
 78, 84, 89, 104, 174, 197
 in fowls, 92
 Brachyphalangy, 90, 91
 Brachysm, 35
 Brains of twins, 186
 of ataxic pigeons, 109
 of negro, 233
 Branchial fistula, 130
 Brazil, 65, 237
 Briggs, H. H., 116
 Brightness and intelligence, 157
 British Columbia, Indians of, 65
 Brittle bones, inheritance of, 75,
 142
 Bronchial asthma, inheritance of,
 138, 188
 Bronchitis, 138
 Brooks, W. K., 7

- Bryant, F. A., 141
 Bryn, 45
 Buenos Ayres, 230
 Bulloch, W., 110, 114, 127, 128, 131
 Bullosa, inheritance of, 128
 Bury St. Edmunds, 61
 Bush varieties of vegetables, 35
- C
- Cacogenic matings, 160
 Cæsar in Gaul, 239
 personality of, 220
 Cæsar's horse, 96, 97
 Cæsarotomy, 34
 Calcar loop, inheritance of, 176
Calliphora erythrocephala, 114
 Cambridge, 94
 California, 39, 146, 157, 178
 Cancer, 123, 140, 141
 Canidæ, variation in, 125
 Cannon, W. B., 217, 218
 Cape Cod, 65
 Capion, Abbe, 114
 Carlisle, Anthony, 104
 Carmichael, W. J., 98
 Carnivora, multiple births in, 200
 Carrel, 41
 Carr-Saunders, 225, 226, 240, 241, 242, 244, 247, 248, 249
 Caste in society, 221
 Castle, W. E., 28, 29, 30, 31, 32, 33, 50, 63, 94, 165
 Cataract, 75, 110, 111, 116
 Catlin, 65
 Caton, Dr. John D., 39
 Cats, on Sable Island, 37
 polydactyly in, 93
 Cattle, albino, 69
 cancer of eye in, 140
 cataract in, 111
 cretins in, 216
 interfertility in, 224
 intoxication by pampas grass, 167
 notch in ear of, 135
 on Sable Island, 36, 37
 polydactyly in, 97
 prognathism in, 125
 sterility in, 196
 twin births in, 198, 202, 203
 Caucasians, 101, 212, 215, 231
 Causes of death, 237
 Celosia, fasciation in, 5
 Cephalic index, inheritance of, 145
 Cereals, seedlings of, 74, 175
 Cerebro-spinal meningitis, 153
 Character, defined, 148
 and handwriting, 172
 Chartley herd of cattle, 70
 Cheek, one bigger, inherited, 136
 Child, 4
 Children of native races, 241, 243, 247
 Chillingham cattle, 70
 China, over-population in, 243
 Chinese, hair of, 53
 in crosses, 230
 polydactyly in, 101
 ponies, 35, 126
 race, 215
 Chipmunks, albino, 68
 Chiriguan Indians, 30
 Choice of ideals, 148
 Chorea, chronic, 156
 Chorion, 199
 fusion in cattle, 201, 202
 Chromosomes, accessory, 20
 and phylogeny, 21
 explained, 13, 14, 15
 in heredity, 16, 24
 in man, 20, 22, 209, 210
 of wheat, 22
 sex, 19, 20
 Civilization, causes of downfall, 238, 239
 measure of, 205
 Cladocera, sex intergrades in, 132
 Clasp the hands, 74
 Cleft palate, 130
 Cleppie Bells, 77
 Climate and population, 242
 Clonic spasms in guinea pigs, 167
 Coburn, C. A., 167
 Cockayne, E. A., 61
 Colborn, Zerah, 104
 Cole, L. J., 112, 167
 Colmar, 55
 Coloboma, inheritance of, 116, 120, 130
 Colour-blindness, 19, 22, 24, 110, 112, 113, 114, 115
 in Europe, 113
 Colour varieties of mankind, 212
Columba livia, 50
 ænas, 50
 Compton, R. H., 72, 74, 75
 Conard, H. S., 75
 Conklin, E. G., 72
 Constricted eyelids, 109
 Convicts, British, 140
 Cook, O. F., 35
 Cornea, degeneration of, 116
 nodular opacity of, 116
 Corns, 5

- Corpora lutea, 177, 178, 196, 200
 quadrigena, 211
 Correlation-coefficients, 28, 30, 32,
 139, 140, 145, 146, 185, 209
 Cortez, 65
 Cotton, short internodes in, 35
 Cragg, E., 90
 Cranial capacity of early man, 246
 Cretin, babies, 216
 cattle, 216, 217
 Crew, F. A. E., sex of frogs, 132
 Criminals and inheritance, 163
 classification of, 184
 feebleminded, 149
 Crooked little finger, 193
 Cross-bred races, 222, 229
 Crossing, and evolution, 223
 between races, 221, 225, 226,
 227, 228, 229, 232, 233, 236
 Cuba, 99
 Cumberland, 113
 Cunier, F., 118
 Cunningham, J. D., 72
 Curled hair, 53, 126, 127
 Cushing, Harvey, 88, 89
 Cuvier, 114
 Cyclopia, 4, 193
 Cytolysin, 144
- D
- Dachshund, 40, 126, 215
 Daltonism, 112
 Dampier, 65
 Danforth, C. H., 92, 111, 180
 Darien, 65
 Darwin, C., 3, 54, 60, 99, 102, 129,
 148, 149, 168, 169, 170,
 193, 205, 220, 240, 241
 Erasmus, 168
 Daughters of Brigham Young, 143
 Davenport, C. B., 27, 28, 29, 30,
 35, 39, 41, 43, 52, 53, 58, 75,
 95, 122, 123, 125, 141, 153, 157,
 158, 162, 163, 194, 195, 196, 197,
 200, 222, 235, 236
 Deafness, 120
 Deaf-mutism, inheritance of, 106,
 107
 Dean, Bashford, 68
 Death, causes of, 237
 rates, 237, 238, 243
 Decay of teeth, 124
 Decline in birth-rate, 244, 245
 Deer, blastocyst of, 177, 178
 Defectives, marriage of, 161
 Deformities, origin of, 71
 Dementia præcox, 156, 158
 Democratic Society, 221
 Denmark, eye colour in, 45
- Département d'Isère, 104
Descent of Man, 102, 241
 Detlefsen, J. A., 69, 98, 111
 Development of the human mind,
 225
 Dexter Kerry cattle, 216
 Diabetes insipidus, 128, 236
 Differences between classes, 249
 Differential birth-rate, 240, 249
 Differentiation of tribes, 226, 227
 Digital abnormalities, 76
 Diploid chromosome numbers, 21
 Disharmonies, physical, 222, 236
 Dislocation of the lens of the eye,
 130
 Disposition in twins, 180, 189
 Dizygotic twins, 192, 202
 Dogs, coat colour in, 67, 69
 eye colour in, 49
 length of tail in, 68
 pariah, 41
 on Sable Island, 37
 polydactyly in, 93
 prosopia in, 126, 215
 turnspit, 41
 variations in, 125
 Dolichocephalic skulls, 212
 Dominance, 24
 variable, 55
 Dominant factors, 174
 Dönitz, 125
 Double monsters, 179, 181, 199
 Double-yolked eggs, 203
 Drawings of animals, 155
 Drinkwater, H., 80, 81, 82, 83, 85,
 86, 88, 90, 136, 170
 Drosophila, 17, 20, 25, 48, 90, 100,
 114, 132, 140, 196, 224
 Ductless glands. See Endocrine
 glands
 Duerden, J. S., 25
 Dugdale, 160
 Duke Ernst the Iron, 124
 Duncan, F. N., 89
 Duplicate twins, 181, 182, 184,
 186, 188
 Dwarfness, inheritance of, 7
 Dwarfs, human, 34, 35, 43, 44, 65,
 212, 215, 216
 trees, 36
 varieties, 36
 Dwight, Timothy, 40
 Dynamometer and will power, 155
- E
- Ear, bilobed, 135
 conformation of, 25, 26
 lobe fissure, 26

- Ear, lobe, pitted, 135
 notch in cattle, 135
 pit, inherited, 136
 Earl of Shrewsbury, 87
 Early man, cave drawings of, 155
 Ears of negroes, 236
 small, in house mouse, 134
 East, 159, 245
 East and Jones, 20
 Edentates, 178
 Edentulism, 130
 Edwards family, 160
 Effect of body on mind, 166
 Effects of adrenalin, 218
 Elderton, Ethel M., 146, 184
 Elimination of characters, 208, 209
 of feeble-mindedness, 169
 Ellis Island, 232
 Embleton, D., 76, 77
 Embryonic budding, 176, 177, 178
 191, 199
 Emigration, effect of, 240
 Endocrine glands, 153, 178, 210,
 211, 213, 217, 218, 228
 and personality, 219, 220
 and physiognomy, 64,
 142, 217
 and temperament, 142
 Endoderm and death, 237
 England, 237
 deaf mutes in, 107
 population of, 244
 and Wales, birth-rate of, 239
 English in crosses, 228, 230, 231,
 232
 Enriques, Paolo, 114
 Environment, 4, 5, 6, 145, 146,
 190, 227
 effect on character, 145
 on wild horses, 38
 Epidermolysis bullosa, 127
 Epilepsy, 154, 155, 163, 164, 220,
 235
 and feeble-mindedness, 158
 Epiphyses in brachydactyly, 81
 Epitarsus, 116
 Eskimo, stature of, 28, 43
 Estabrook, A. H., 149, 160
 Eugenic action, 173
 matings, 160
 Eugenics, aims of, 204
 Eunuchoid races, 215
 Evening primroses, 206
 Evolution and crossing, 223, 233
 and isolation, 224
 in man, 225, 226, 246, 248
 of civilization, 247
 of mentality, 152
 Exogamy, 227
 Expression in twins, 187
 Eye colour, inheritance of, 25, 27,
 44, 58, 145, 187, 207,
 229
 primitive, 64
 defects, 116, 130
 Eyelids, constricted, 109
 Eyes, absence of, 120
 of negroes, 236

 F
 Facial types, 219, 224
 Fackenheim, J., 97
 Factors, dominant, 174
 growth, 28, 33
 inhibiting, 35
 lethal, 90, 114, 140, 174, 196,
 197, 209
 multiple, 27, 33, 34, 39
 Farabee, W. C., 78, 82
 Farmer, J. B., 20
 Fasciation of stems, 5
 Fay, Edward A., 107
 Fear and bodily changes, 217
 Fecundity of man, 241, 243
 Feeble-mindedness and Palæo-
 lithic man, 225
 arrested development in, 235,
 247
 inheritance of, 17, 147, 149,
 150, 154, 156, 157, 158, 161,
 166
 in pigeons, 167
 in relation to insanity, 155
 Feeble-minded in United States,
 152, 158, 159, 160, 232
 reproduction in, 251
 Femur, length in deer mouse, 33
 Feral animals, 36, 38
 Ferguson, G. O., 234
 Fertilised eggs in hybrids, 16
 Fildes, Paul, 110, 114
 Filipinos, hair of, 53, 54
 Finger prints, 175, 176, 180, 182,
 183
 types of, 175, 184
 Fischer, Eugen, 55, 56, 229
 Fisher, R. A., 108
 Fishes, cyclopean, 4
 eggs of, 177
 hermaphroditic, 133
 Flexure of finger joint, 193
 Flinders-Petrie, 221
 Flower-size, inheritance of, 33
 Folker, H. H., 116
 Formula for growth of population,
 245
 Formulæ for ancestral influence,
 210

- Formulae for systems of breeding, 208
- Fowls, brachydactyly in, 92
 eye colour in, 50, 51
 hermaphroditism in, 132
 polydactyly in, 93, 95, 97
- Foxes on Sable Island, 37
 prognathism in, 125
- France, 246
- Frederick Wilhelm of Prussia, 43
- Free-martins, 198, 200, 202
- French in crosses, 231
- Frequency of twins, 194
- Freud, 165
- Friedenthal, Hans, 54
- Frobelius, 130
- Frogs, change of sex in, 132
- Functional inheritance, 144
- Fusion of races, 223
- G
- Gaits in twins, 190
- Gallic tribes, 239
- Galton, Sir Francis, 2, 27, 149, 175, 184, 187, 188, 193, 209
- Gamboge's Raleigh, 135
- Garden peas, heredity in, 8
- Gastropods, reversed symmetry in, 72
- Gastrula of armadillo, 177
- Genius and ability, 222
 and insanity, 155, 156
- Georgia, 109
- Germans in crosses, 230
- German tribes, 239
- Germany, 65, 137, 160, 246
 birth-rate of, 239
- Germ cells, 14
- Germinal change, 5, 13
- Germ plasm, 144, 156, 159, 209, 210, 217, 250
 recessive characters in, 19
- Gigantism, 41, 42, 43, 101, 212
- Gilpin, J. B., 36, 37, 38
- Glaucoma, 116
- Gluteal prominences, 130
- Goats and goitre, 215
 breed in Kentucky, 166
 on Sable Island, 37
- Goddart, 149, 150, 152, 153, 155, 232
- Goitre, 215
- Goldsmith, W. M., 133
- Gorilla and pituitary, 217
- Goring, Chas., 139, 140
- Gossage, A. M., 127
- Gowen, John W., 202
- Gower's disease, sex-linked, 110
- Greece, downfall of, 238, 245
- Greek race, 205
 in crosses, 230
- Grey hair, inheritance of, 25, 53
- Growth curves, 32
 of population, 245
 hormones, 41
- Guinea-pigs, coat colour in, 48, 125
 eye colour in, 50
 palsy in, 167
 polydactyly in, 93, 94
 resistance to tuberculosis in, 140
- Guyer, M. F., 20, 154
- Guyer and Smith, 144
- Gynandromorphs, human, 131
- H
- Haddon, A. C., 223
- Haecker, V., 124, 125
- Hæmophilia, 110, 114
- Hæmorrhoids in negro troops, 235
- Hag-fisher, albino, 68
- Hair, absence of, 55
 characters, 53, 54, 55, 214, 217
 colour, 224
 inheritance of, 25, 51, 53, 145, 187, 190, 229
 distribution of, 54
- Hairiness, 126
- Hairy face, 55
- Hallam, Colonel, 99
- Hamburgs, gold-pencilled, 31
- Hancock, Thomas, 37
- Handwriting, 108, 171, 172
 in twins, 187, 189, 190
- Hanna, G. D., 133
- Hapsburg jaw, 88, 124
- Hardy, 164, 208
- Hare-lip, 130
- Harman, N., 59, 110, 111
- Harrison, 92
- Hawaii, racial crossing in, 230
- Hawkes, Onera A. M., 106
- Hayden, C. C., 198
- Hay fever, inheritance of, 138
- Health, inheritance of, 145
- Hemeralopia, 115
- Hennig, 103
- Heptadactyly, 102
- Herbivora, multiple births in, 200
- Hereditary Genius*, 149
- Heredity, 2, 4, 6, 8, 237, 251
 defined, 7
 limits of, 175

- Hermaphroditism, 130, 132, 133, 193, 201
 Hermaphroditismus masculinus, 193
 Heron, 151
 Heterochromidia iridis, 49, 61
 Heterodactyly, 95
 Heterosis, 29, 205, 206, 230, 231, 232
 Heterozygous, characters redistributed, 173
 defined, 10
 dominants, 16
 Hexadactyly, 75, 93, 95, 102, 103, 104, 105, 193
 Hill folk, 160
 Hindu Amil community, 71
 Hipparion-toes, 96
 Hoffman, H., 158
 Holden, Jane, 122
 Holmes, S. J., 61, 150, 152, 156, 245
 Homer, 38
 Homozygous, defined, 11
 condition in man, 192, 206
 Honduras piebald, 59
 Hooper, J. J., 166
 Hope and French, 126
 Hormones, 30, 33, 41, 42, 201, 210, 215, 216, 217, 219, 220
 Horne, J., 107
 Hornlessness, 126
 Horses, albino, 71
 colour of wild, 38
 dwarf, 35
 eye colour of, 49
 inheritance in, 99
 intoxication by pampas grass, 167
 on Sable Island, 36, 37
 polydactyly in, 93, 96, 97
 Horstmann, Elizabeth, 103
 Hottentots, crosses of, 229
 food of, 227
 stature of, 43
 women, 130
 Hover, J. M., 142
 Howe, Lucien, 94, 116
 Huddart, Joseph, 113
 Huestis, R. R., 33
 Humours in the blood, 219
 Humphreys, Col. David, 40
 Hungarian immigrants, 232
 Hunter, John, 63, 201
 Huntingdon's chorea, 156
 Hunting rights of primitive man, 227
 Hurlin, R. G., 99, 101
 Hurst, C. C., 44, 49, 51, 71, 75, 149, 167, 170
 Huxley, 93
 Huxley, J., 132
 Hybridization in man, 223, 238
 Hybrid origin of races, 223
 races, 228, 229
 vigour, 205, 206, 230, 232
 walnuts, 205
 Hydrocele, 193
 Hyperdactyly, 101
 Hyperkinetic temperaments, 162, 164
 Hyperpituitary face, 220
 Hypertrichosis, 130
 Hypodactyly, 105
 Hypophalangy, 90
 Hypophysis, 41
 Hypospadias, 130, 193
 Hypothyroidism, 215, 216
 Hypotrichosis, 128
 Hysteria, 163, 164, 235
- I
- Ichthyosis, 117, 118, 122, 127
 Idiocy in Jews, 142, 158
 Idiots, 149, 153, 156, 157, 215
 Illinois, 97
 Illness in twins, 188, 189, 190
 Imbeciles, 149, 154, 155, 156, 157
 Immigrants in United States, 232, 236
 Inbreeding, 140, 143, 206, 207, 208, 209, 223, 238
 India, 41, 71, 243
 Indians, American, stature of, 28, 30, 43
 crosses of, 231
 horses of, 38, 223
 lefthandedness in, 72
 tribes of, 223, 226, 227
 white, 65
 Industry and population, 241, 242
 Infanticide, 71, 238, 241, 243
 Inge, Dean, 238, 244
 Inheritance, 2
 alternative, 7, 27, 99, 147, 148, 205, 223, 229, 232
 blended, 27, 52, 232
 functional, 144
 in horses, 99
 in twins, 176, 179, 180
 Mendelian, 9
 mental, 145, 149, 164, 165, 166, 168, 170, 186
 of ability, 145, 147, 148, 149, 250
 of abnormalities, 9, 75, 76, 106, 116, 125, 127, 129, 130
 of absence of external ear, 133, 134

- Inheritance of absence of patella, 136
- of acquired characters, 5
 - of artistic ability, 170
 - of athletic power, 145
 - of auricular height, 145
 - of bilateral asymmetry, 191
 - of bilobed ear, 135
 - of bimanual synergia, 136
 - of branchial fistula, 130
 - of bronchial asthma, 138
 - of calcar loop, 176
 - of cancer, 140
 - of cephalic index, 145
 - of character, 147
 - of cheek, one large, 136
 - of cleft palate, 130
 - of clonic spasms in guinea-pigs, 167
 - of coloboma, 116, 120, 130
 - of colour-blindness, 19, 22, 24, 110, 112, 113
 - of constricted eyelids, 109
 - of criminality, 163
 - of curliness of hair, 145
 - of differences in endocrine glands, 142
 - of disposition, 147
 - of dwarfing, 34
 - of edentulism, 130
 - of effect of cytolyisin, 144
 - of eye colour, 145
 - of fingerprints, 175, 176, 180, 182, 183, 184
 - of gait, 3, 190
 - of gluteal prominences, 130
 - of hair colour, 145
 - of handwriting, 108, 145
 - of hare-lip, 130
 - of hay fever, 138
 - of hermaphroditism, 130, 131, 132, 133
 - of hypertrichosis, 130
 - of hypospadias, 130
 - of insanity, 155, 156
 - of iso-agglutinin reactions, 129
 - of Jewish physiognomy, 142
 - of luxation of femur, 130
 - of mathematical ability, 147, 149
 - of mental differences, 145, 146, 147, 236
 - of musical ability, 147, 149
 - of mutilations, 26
 - of neurofibromatosis, 141
 - of notch in ear of cattle, 135
 - of openings in parietal bones, 133
- Inheritance of peculiarities of the blood system, 137
- of personality, 220
 - of pitted ear-lobe, 135
 - of polydactylism, 76, 92, 93, 94, 96, 97, 101, 102, 103, 126, 130, 180
 - of polymastia, 129
 - of rudimentary ear-lobes, 133, 134
 - of savageness in rats, 167
 - of scute peculiarities in the armadillo, 181
 - of size, 26-35
 - of stammering, 141
 - of strabismus, 115, 120, 130
 - of temperament, 147, 236
 - of tendency to blush, 3
 - of timidity in rats, 167
 - of tuberculosis, 139
 - of tumours, 140
 - of twinning, 178, 194
 - of warts on the hands, 123
 - of wildness in rats, 165, 166, 167
 - particulate, 27
 - sex-linked, 19, 23, 25, 47, 61, 110, 112, 114, 115, 116, 117, 118, 120, 122, 123, 124, 154, 163
 - through the Y-chromosome, 94, 101, 119, 210
- Innocuous characters, 207
- Insanity, 154, 155, 157, 166, 188
- Instincts in man, 165
- Intelligence, 157, 171, 190, 224, 233, 234, 243, 246, 248, 249
- Intermarriage of strains, 222
- Intersexes, 131, 132, 193, 201
- Interstitial tissue of the gonads, 211, 212
- Intoxication in animals, 92, 167
- Introduced animals on Sable Island, 37
- Iodine, in thyroxin, 214
- in water, 215
- Iowa, 99
- Ireland, 49
- deaf-mutism in, 106, 107
 - over-population in, 243
- Irish in crosses, 230
- Iso-agglutinin reactions, 129
- Isolation and origin of differences, 224, 226, 227, 238
- Italians, in crosses, 230, 233
- immigrants, 232
 - stature of, 30
- Italy, pellagra in, 122
- white cattle in, 71

J

- Jamaica, 52
 Japanese, Aino, 54
 and modern science, 226, 248
 dwarf trees, 36
 in crosses, 230, 231
 race, 215
 Jaw appendages, 126
 Jenks, A. E., 26, 135
 Jennings, H. S., 208
 Jewish race, 141
 Jews, 142, 158, 232
 Jones and Arnold, 167
 and Mason, 111
 Jordan, H. E., 53, 71, 73
 Joseph, William, 101
 Jung, 165

K

- Kaleia, Gratio, 103
 Kallikaks, 160
 Kalmucks, ears of, 134
 Karakul sheep, 135
 Kassowitz, 34
 Keith, Sir Arthur, 211, 212, 213,
 214, 215, 216, 217
 Kempf, Edward J., 165, 168, 169
 Kempton, J. H., 35
 Kentucky, 43, 166
 Keratosis, 5, 75, 121, 127
 Key, Wilhelmine, 160, 162
 Kindred, J. E., 136
 Klebs, 131
 Koch, Mathilda L., 109
 Kühn, J., 125

L

- Lactation period in primitive
 races, 241
 Lambert, Edward, 120
 Lane, W. C., 109
 Languages of Indian tribes, 227
 Laplanders, 231
 Laughlin, H. H., 209, 210
 Law of ancestral inheritance, 209
 of diminishing returns, 241,
 242
 of Malthus, 240
 of Nasse, 110
 Lawrence, T. W. P., 131
 Learmonth, J. R., 129
Lebistes reticulatus, 94
 Le Compte family, 117
 Left-handedness, frequency of,
 72
 inheritance of, 71, 90
 measurement of, 73
Lemna minor, 42

- Length of digits in foot, 106
 Lenz, Fritz, 110
 Lepidoptera, 64
 Leporata, Francesco, 43
 Lepra bacillus, 123
 Leprosy, 123
Lepus variabilis, 69
 Lethal factors, 90, 114, 140, 174,
 196, 197, 209, 217
 Leucoderma, 66
 Lewis, T., 76, 77, 78, 84, 93, 140
 Lillie, F. R., 201
 Little, C. C., 67, 230
 Little and Gibbons, 114
 "Lobster claw," 75, 76, 91
 Loeb, Leo, 140, 141
 London, 55
 Lort, Rev. Michael, 112
 Louisiana, 63, 99
 Love, A. G., 235
 Love, J. K., 107
 Lundborg, H., 106, 108, 158, 231
 Lush, J. L., 135
 Luxation of the femur, 130
 Lynch, Clara J., 134

M

- MacBride, E. W., 144, 178
 MacCaughey, V., 230
 MacDonald, James, 70
 MacDougal, William, 146, 147,
 168, 248, 249, 250
 Machin, John, 120
 Mackinder, D., 90
 McMullen, Geo., 78
 Magdalenian man, 247
 Maine, 110
 Maize, brachysm in, 35
 Malays, 215, 248
 Malformations, inheritance of, 130
 in twins, 192
 Maltese family, 93, 103
 Malthus, 240, 241, 242
 Mameluco, 228
 Mammals, variations in, 125, 126
 Mandan Indians, hair of, 53
 Mandibles of deer mouse, 33
 Manic depressives, 158
 Manner in twins, 187
 Manson, J. S., 101
 Manual education for negro, 235
 for mentally defective,
 150
 Marchaud, 103
 Marriage selection, 160
 control of, 162, 244
 Martin, P. J., 122
 Maryport, 113

- Massachusetts, 36, 40, 65, 94
 Mathematical ability, inheritance of, 147, 149
 laws of inheritance, 207
 Measuring scale of intelligence, 149
 Medici, de, Catherine, 44
 Mediterranean race, 212
 Meiosis, defined, 15
 Melancholia, 158
 Melanism in Lepidoptera, 64
 Melanogenesis, 53
 Mendel, 8, 14, 17
 Mendelian, dominant, 25, 60, 75, 76, 78, 88, 89, 90, 103, 105, 109, 110, 111, 114, 117, 124, 126, 127, 128, 133, 135, 136, 141, 156, 208
 inheritance, 9, 14, 17, 24, 48, 52, 72, 207
 population, 208, 209
 recessive, 106, 107, 108, 109, 110, 111, 115, 122, 134, 138, 149, 150, 158, 167, 173, 208, 217
 Mental capacity of modern man, 225
 characters, inheritance of, 145, 164, 166, 168, 170, 186, 188, 221
 complexes, 165
 defects, 154, 188
 evolution, 226
 instability in crosses, 231
 tests for immigrants, 232
 of negroes, 234
 Mentality of man, 165
 of negro, 234, 235, 247, 248
 Menzies, Sir W., 98
 Mesenchyme, hereditary inferiority of, 142
 Metchnikoff, 131
 Mexico, 65
 Mice, cancer in, 140
 waltzing, 167
 wildness in, 167
 yellow, 196
 Microcephaly, 133
 Microphthalmus, 116, 120, 130
 Migraine, 163
 Migrations, 223, 226, 239
 Miller, N., 62
 Milroy, W. F., 127
 Minnesota, 69
 Minor brachydactyly, 82, 88
 Minutiæ of finger prints, 175, 176, 183
 Mirror-image patterns, 176, 179, 182
 Mirror-writers, 73
 Miscarriages, 196, 198
 Miscegenation, 222, 233, 236, 239
 Mivart, St. George, 125
 Mixture of races, 223, 236
 Mjoen, J. A., 231
 Mohr, O. L., 89, 90, 91
 Momentary blindness, 117
 "Mongolian," 152, 153
 Mongoloids, features of, 214, 215
 pituitary of, 212, 214
 stature of, 28
 Monilithrix, 128
 Monkey, chromosomes of, 21
 polydactyly in, 93
 Monomaniac twins, 188
 Monozygotic twins, 191, 192, 199, 202
 Montezuma, 65
 Montgomery, 20
 Montpellier, 114
 Moore, 20
 Mores and society, 163
 Morgan, T. H., 196
 Morons, 149, 150, 152, 154, 157
 Mott, F. W., 158
 Mouse, Californian deer, 33
 house, mutation in, 134
 Moustarian man, 225
 Mulattoes, 52, 53, 234
 Multiple births in man, 197, 200
 factors, 27, 33, 34, 39, 167
 Musical ability, inheritance of, 147, 149, 170, 171
 Mutations, 13, 17, 38, 41, 64, 66, 68, 70, 75, 77, 85, 95, 99, 109, 111, 125, 134, 140, 151, 174, 175, 207, 217
 following crossing, 59, 63
 parallel, 125
 sex-linked, 20
 Myoclonus-epilepsy, 108, 158
 Myopia, 115, 116
 Myxœdema, 214
- N
- Nam family, 160
 Napoleon, personality of, 220
 Nasse, law of, 110
 Native races, 207
 Natural selection, 175, 207, 209, 211, 240, 243, 246
 Naval officers, heredity in, 164
 Neanderthal skull, 216
 Negrillo Akkas, 43
 Negroes, brain of, 233
 compared with whites, 235, 236

- Negroes, crosses of, 233
 features of, 214
 hair and skin of, 52, 54, 59, 63
 lefthandedness in, 72
 mentality of, 152, 234, 247, 248
 pituitary in, 212
 polydactyly in, 93, 101
 Negro, troops in American army, 225
 twins, 180
 Nelson, 164
 Neolithic races, 223
 Nervous derangements, inheritance of, 166, 167
 system, differences inherited, 210, 220
 of negroes, 235
 Nettleship, E., 57, 61, 110, 114, 116
 Neuralgia, 235
 Neurasthenia, 218, 220, 235
 Neurofibromatosis, 141
 Neurotic stocks, 156
 Newman, H. H., 115, 119, 176, 177, 178, 181, 199
 New York, foreign born in, 236
 sex-ratios in, 230
 Nichols, 202
 Nietzsche, 220
 Night-blindness, 68, 75, 114, 115, 116, 189
 Nilsson, M. P., 238
 Nineveh, sculptures of, 37
 Nomadism, 162, 163
 Nordic race, 141, 212, 231
 Norfolk Islanders, 228
 North Carolina, 43, 115
 Norway, 90, 134, 141, 104
 albinos in, 65
 deaf-mutes in, 106
 eye colour in, 45, 48
 polydactyly in, 96
 racial crossing in, 231
 Nose-bleed, hereditary, 109
 Notch in ear of cattle, 135, 203
 Nougaret, Jean, 115
 Nucleus, in mitosis, 13
 Nyassaland, 59, 71
 Nyctalopia, 117
 Nystagmus, 116
- O
- Oats, bush varieties of, 35
 Occipital meningocele, 193
 Ocular defects in twins, 190
 Œdema, angioneurotic, 127
 persistent hereditary, 126, 127
- Enothera gigas*, 21
Lamarckiana, 21
 bud colours in, 58
 chromosome numbers in, 21
 flower-size in, 33
 self-pollination in, 206
 Ohio, 158, 197, 198
 Openings in parietal bones, 133
 Ophthalmia in twins, 188
 Optic nerve, atrophy of, 116
 Optimum density of population, 242, 243
 Orang and thyroid, 217
 Ordahl, G., 157
 Organic social condition, 249
 Organism, relation to environment, 6
 development of, 14
 Osborn, Dorothy, 25
 Osteopsathyrosis, 75
 Ostrich hybrids, 26
 Otis, Arthur S., 157
 Otosclerosis, 107
 Ottawa, 39
 Over-population, 243, 244
 Oxford class lists, 146
- P
- Pain and bodily changes, 217
 Painter, T. S., 21
 Palæolithic man, 151,
 mental states of, 225, 226, 247, 248
 races, 223, 225
 Palm and sole patterns, 176
 Palsy in guinea-pigs, 167
 Pancreas, 211
 Parathyroid glands, 211
 Pariah dogs, 41
 Parietal bones, conformation of left, 193
 openings in, 133
 Parthenogenetic larvæ, 178
 Parthenon, 38
 Patagonia, 38
 population in, 242
 Patella, absence of, 136
 Patiria, 178
 Patterson, J. T., 176, 177, 181, 199
 Pearl, Raymond, 92, 198, 208, 229, 230, 237, 245
 Pearson, Karl, 34, 35, 44, 52, 57, 58, 59, 60, 61, 64, 65, 66, 68, 77, 78, 139, 145, 146, 151, 153, 157, 171, 208, 209
 Peas, bush varieties of, 35
 Peculiarities of blood system, 137
 Pekinese dogs, 69

- Pellagra, 122, 123
 Pelvic bones, length in deer mouse,
 33
 Pennsylvania, 79, 160, 161
 Percy, Harry (Hotspur), 62
Peromyscus maniculatus, 33
 Personality, 219, 221
 Pfitzner, 101
Phaseolus vulgaris, 206
 Phlegmatic temperaments, 162
 Philippines, 180
 Phocomelia, 193
 Phrenology, 220
 Piebaldism, 38, 50, 59, 61, 66, 67
 Pigeons, ataxia in, 109, 167
 eye colour in, 50, 51
 polydactyly in, 95
 twins in, 203
 sex-ratio in crosses, 230
 Pigs, abnormal race of, 99
 corpora lutea in, 196
 on Sable Island, 36, 37
 polydactyly in, 97
 syndactyly in, 98
 Pima Indians, 72
 Pineal gland, 142, 211
 Pinus, polyembryony in, 179
 Pitcairn Island, 228
 Pit in skin, inheritance of, 136
 Pitted ear-lobes, inheritance of,
 135
 Pittsburg school-children, 249
 Pituitary and personality, 219
 and size, 32, 35, 41, 43, 142,
 211, 212
 in gorilla, 217
 Pituitocentric personalities, 220
 Pityriasis versicolor, 123
 Plane-tree in London, 205
 Plate, 106
 Pliny, 101
 Pneumonia in negro troops, 235
Poa argentina, 167
 Pollen grains of rice, 15
 Polydactyly, 76, 92, 93, 94, 96, 97,
 101, 102, 103, 126, 130, 180
 Polyembryony, in armadillo, 176,
 177, 178
 in pines, 179
 Polymastia, 102, 129
 Polynesians, 43, 228
 Polyuria, 128
 Pond, Clara P., 101
 Ponies, Chinese, 35, 126
 Sable Island, 36
 Shetland, 35, 36
 Pontianak, Sultan of, 103
 Poole, 65
 Popenoe, Paul, 143, 164, 190
 Population, 239, 240, 241, 244,
 245, 246
 "Porcupine man," 120
 Porokeratosis, 128
 Portuguese in crosses, 228, 230
 Poultry, polydactyly in, 95
 weight in, 31
 Prepotency, 142, 143
 Pribiloff Islands, 133
 Priestley, Rev. Joseph, 113
 Primitive culture, 225
 man, 226, 227, 241, 243, 248
 Primula, self-sterility in, 224
 Prognathism, 124, 125
 Protozoa, 41
 behaviour in, 165
 Prussia, 199
 Psychical characteristics, 146
 Psychoanalysis, 166, 168, 170
 Psychological analysis of the
 mind, 147, 164
 Psychology, 165, 168
 Psychopathology, 165, 168
 Pterygium, 116
 Ptosis, 116
 Puberty and stature, 41
 Punnett, R. C., 9, 31, 159
 Pure lines, 221
 Pygopagous twins, 179
- Q
- Quadruplets in armadillo, 176,
 181, 182
 in man, 197, 200
 Quantitative characters, 9, 213
 Quantity in population, 245
 Queen Charlotte Islands, Indians
 of, 65
- R
- Rabbits, colour in, 48, 125
 corpora lutea of, 196
 eye colour in, 49
 inheritance of size in, 29, 32
 weight in, 31
 injection of serum, 144
 on Sable Island, 37
 Racial characters, 9
 in man, 210, 211, 214, 217,
 224
 crosses, 213, 221, 224, 228,
 229, 230, 231, 232, 233, 236
 Radiographs, 80, 85
 Rage and bodily changes, 217
 Raleigh, 164
 Ramaley, F., 72
 Random mating, 208, 209

- Rats, cancer in, 140
 inheritance of wildness in,
 165, 166
 of waltzing in, 167
 on Sable Island, 37
- Ray pattern eye colour, 49
- Reaumur, 93, 103
- Reduction divisions, 14, 15, 20, 24
- Reed, L. J., 245
- Reheboth hybrid people, 229
- Reproductive overwork, 109
- Reptiles, hermaphrodites in, 133
- Resemblances, inheritance of, 24
 in identical twins, 200
- Retinitis pigmentosa, 116
- Reversed symmetry, 72, 179
- Rice hybrids, 15
- Rickets, 42
- Riddle, O., 109, 167
- Ridge patterns of finger tips, 176,
 180, 183
 of palms and soles, 176,
 179
- Rieder, H., 91
- Rischbieth, H., 34, 130
- Ritzman, E. G., 134
- Roberts, Elmer, 97, 98
- Robins, albino, 68
- Rodentia, multiple births in, 200
- Roman rule, 238, 239
- Rome, downfall of, 238, 245
- Röntgen rays, 141
- Rudimentary ear lobules, 134
- Rüdin, Ernst, 158
- Russians, immigrants, 232
 in crosses, 230
- S
- Sable Island, 36, 38
 wild horses on, 37
- Salaman, R. N., 141, 142
- Salamanders, 41, 42
- Saltations, 126
- Samar Island twins, 180
- San Francisco, 39
- Sano, F., 186
- Santa Cruz Island, 39
- Sarcoma, 140
- Savageness, inheritance of, 167
- Scandinavians, eye colour in, 64,
 207
 migrations of, 239
- Schaefer, 218
- Schmidt, Johs, 94
- Schofield, R., 61, 94, 100, 135
- Schroeder, 105
- Schultz, A. H., 100
- Schurmeier, 100
- Schuster, E., 146
- Schweizer, Marie, 103
- Scotch in crosses, 230
 stature of, 30, 43
- Scotland, albinism in, 66
 deaf-mutism in, 107
- Scott, J., 112
- Scurvy, 42
- Scutes in armadillo, 181
- Seals, hermaphroditism in, 133
- Sebaceous scalp tumours, 123, 124
- Sedgwick, William, 25, 49, 53, 66,
 67, 76, 105, 117, 119, 120, 121,
 122, 123, 124, 133, 134, 136, 155
- Sedigiti, 101
- Seedlings, right-handed, 74
- Segmentary social condition, 248
- Segregation of characters, 8, 13,
 15, 213, 222, 229
- Selection, 221, 223
 against feeble-mindedness, 159
- Self-fertilisation, 208, 209
- Self-pollination in *Oenothera*, 206
- Self-sterility in plants, 224
- Seligman, C. G., 102, 216
- Sella turcica, 41
- Serums, 26, 129, 144
- Sessions, Mina A., 158
- Sex chromosomes, 19, 132
 in insects, 22
 in man, 20, 22, 210
- Sex-determination, 19, 22, 201
- Sex-linked inheritance, 19, 20, 47,
 61, 110, 112, 114, 115, 116, 117,
 118, 120, 122, 123, 124, 154,
 163
- Sex of twins, 195
- Sex-ratio, in crosses, 229, 230
 after war, 239
 of twins, 202
- Sexual selection, 77, 207
- Shattock, S. G., 132
- Sheep, Ancon, 40
 earless, 134
 horns in, 61
 intoxicated by pampas grass,
 167
 on Sable Island, 37
 thyroid, 214
 twins, 194, 202
- Shelley's face, 219
- Shell-shock, 218
- Shetland ponies, 35
- Shifting of peoples, 223, 226, 239
- Siamanga syndactyla*, 100
- Siamese, 215
- Siemens, H. W., 158
- Simpson, Q. I., 63
- Sinclair, James, 70

- Sinistro-dextral ratio, 33
 Size factors, 29, 31
 Size inheritance, 29, 30, 32, 34, 39
 in plants, 33
 Skiagraphs, 87, 101
 Skin colour, 2, 4, 213, 224
 and hormones, 212, 213,
 217
 inheritance of, 51, 52, 58,
 64, 228, 229
 of primitive man, 63
 diseases in negroes, 235
 secretions, 224
 Slye, Maude, 140
 Social dominance of white man,
 215
 ladder, 250
 organization of early man,
 226
 Soudan, 43
 Spanish in crosses, 230
 Sparrows, albino, 68
 Species, interfertility of, 224
 Spermatogenesis, human, 20, 21,
 22, 158
 Spleen, enlarged, 128
 Split hand and foot, 76, 78
 Sports, 175
 Spotting of skin, 58, 59, 63, 66, 67,
 68, 69
 inheritance of, 69
 Spread of culture, 227
 Squinting. See Strabismus
 Squirrels, albino, 68
 Stability of savage populations,
 227
 Stammering, inheritance of, 141
 Standard of living, 242, 243
 Standley, Paul C., 69
 Stannus, H. S., 58, 59, 71
 Stanton, H. M., 171
 Starfish, twin embryos in, 178
 Stark, 140
 State Eugenics Board, 162
 Stature, 224
 and hormones, 212, 217
 inheritance of, 25, 27, 40, 41,
 43
 of brachydactyls, 82
 of twins, 187, 189, 190
 Sterility in free-martin, 201
 in mankind, 196
 interspecific, 224
 Sternalis muscle, 193
 Stieve, H., 92
 Still-births, 230
 St. John, Harold, 36
 Stockard, C. R., 4, 176, 177
 Stone Age, 225
 Storer, Rev. John, 70
 Strabismus, 115, 120, 130
 Stratification of society, 221
 Striping of flowers, 50, 58
 Stuckey, H. P., 109
 Stuttering, 74
 St. Vitus' Dance, 156
 Subpituitary face, 220
 Suetonius, 97
 Sulcus intertragicus, 26
 Sullivan, L. R., 180
 Sumner, F. B., 6, 33
 Supernumerary, breasts, 102, 129
 phalanx on thumbs, 92
 Sweden, deaf-mutes in, 106
 myoclonus epilepsy in, 108,
 158
 racial crossing in, 231
 Swedes, stature of, 30
 Swingle, W. W., 132
 Symmetry in armadillo quad-
 ruplets, 181
 Syndactyly, 76, 92, 93, 94, 98, 99,
 100, 101, 126
 Syphilis, 153
- T
- Tahiti, 228
 Taillessness, 126
 Tallness, inheritance of, 7
 Tamias, albino, 68
 Tansley, A. G., 165
 Tarpany horse, 37
 Tastes in twins, 189
Tatusia novemcincta, 177
 Tauræ, 201
 Teeth, early decay of, 124
 Telangiectasis, multiple heredi-
 tary, 127
 Temperamental differences, 142,
 143, 210, 248
 Temperaments, 142, 162, 219, 236,
 in animals, 165
 Tendency to perform certain
 tricks, 148
 Tetraploid chromosome numbers,
 21
 Tetraploidy, 42
 Texas, 21, 99, 115, 135, 176, 177
 Thadani, K. T., 71
 Thalassophilia, 164
 Thessaly, 71
 Thorndike, 198
 Thumb joint, peculiarity in twins,
 190
 missing, 95
 Thyroid, 142
 and baldness, 25
 and race, 211, 212, 213, 215

- Thyroid, action of, 215, 216, 217
 and personality, 219
 and size, 32
 cancer in, of rats, 140
 composition of, 214
- Thyroxin, 214, 216
- Timidity, inheritance of, 167
- Tissue cultures, 41
- Titles, hereditary, 222
- Tomatoes, bush varieties, 35
- Toothache in twins, 188
- Tooth anomalies, 55, 97, 102, 124,
 130, 222, 236
- Toothless families, 71
- Tortoiseshell-coloured eyes, 49
- Tradition, 205, 225, 226, 247, 248,
 249
- Transformation of sex, 131, 132
- Tremor, hereditary, 108
- Tribal differences, loss of, 223
- Triplets, 197, 198, 199
- Triplod chromosome numbers,
 21
- Trivial characters, 207
- Trophœdema, 127
- Tuberculosis, 123, 139
 in crossed races, 231
 in negroes, 235
- Tumbling in pigeons, 167
- Tumours from nerves, 141
 in *Drosophila*, 140
 in pituitary, 212
 sebaceous, 123
- Tupper, W. W., 42
- Turdus migratorius*, 68
- Turkeys, wild, 39
- Turnspit dog, 41
- Twin embryos, production of, 177,
 178
- Twinning, influence of father on,
 195
 inheritance of, 194
- Twins, 76, 146, 173, 175, 176, 178,
 179, 180, 182-193
 effect of separation, 190
 in cattle, 198, 201, 202, 203
 in fishes, 177
 origin of identical, 199
 two types, 198
- U
- Uhlenhuth, E., 41
- Unconscious repression, 165
- Unilateral inheritance, 135, 136
- Uniovular twins, 180
- United States, 237, 250
 Anglo-Saxons in, 245
 arable land in, 245
- United States, births in, 200
 crossing in, 230, 232, 233,
 236
 feeble-mindedness in, 152,
 159
 negro in, 233, 234
 pellagra in, 122
 population of, 245
- Urquhart, A. R., 156
- Usher, C. H., 44, 57, 61
- Uxbridge, 91
- V
- Variation, 1, 5, 6, 7
 blastogenic, 181
 continuity in, 27, 151, 175,
 184
 discontinuity in, 27, 175
 in *Canidæ*, 125
 in hybrid race, 229
 in mammals, 125
 in man, 211
- Vegetables, bush varieties of, 35
 run wild, 39
- Venereal disease in negro troops,
 235
- Vermont, 104
- Vigour from crossing, 29, 206, 223
 in twins, 188
- Vineland Institution, 150
- Virginia, 89
- Vitamines, 42
- Voice in twins, 187, 189, 190
- W
- Walker, 20, 84, 88
- Wallace, A. R., 100, 228, 240
- Walnut hybrids, 205
- Waltzing in mice, 167
- Warren, H. C., 207
- Warts on the hands, 123
 inheritance of, 123
- Washington, Booker T., 235
- Weakening of a character by
 exogamy, 104
- Webbing. See Syndactyly
- Weeks, 158
- Wegelin, Carl, 91
- Weidenreich, 100
- Weight in twins, 187, 189
- Weinberg, 107, 108
- Weismann, 144
- West Indies, 94
- Wheat, bush varieties of, 35
 chromosomes of, 22
 pure lines in, 221
- Whisson, Rev. Mr., 112
- Whitchurch, 87

- White cattle, 70, 71
 forelock, 59, 60, 62
 Wieman, H. L., 20
 Wilder, H. H., 176, 179, 183
 Wildness, inheritance of, 165, 166,
 167
 Wild horses, 37, 38
 turkeys, 39
 Wile, 101
 Windle, C. A., 26, 43, 93, 129,
 137, 192, 193
 Winge, O., 45, 46
 Winwarter, von, 20, 21, 22
 Witschi, Emil, 132
 Wolff, 101
 Wolves, cancer in, 140
 Woodchucks, albino, 68
 Worcester, 40
- Wriedt, Chr., 71, 89, 90, 134
 Wyat, 102
- Y
- Yapp, W. W., 111
 Y-chromosome, 19, 23, 94, 101,
 119, 210
 Yearsley, M., 107
 Yellow and brown races, 225
 Yerkes, R. M., 166, 167
 Youatt, 99
 Young, Brigham, 143
- Z
- Zeleny, C., 199
 Zoönomia, 168
 Zygodactyly, 100





UNIVERSITY OF ILLINOIS-URBANA



3 0112 041833572